

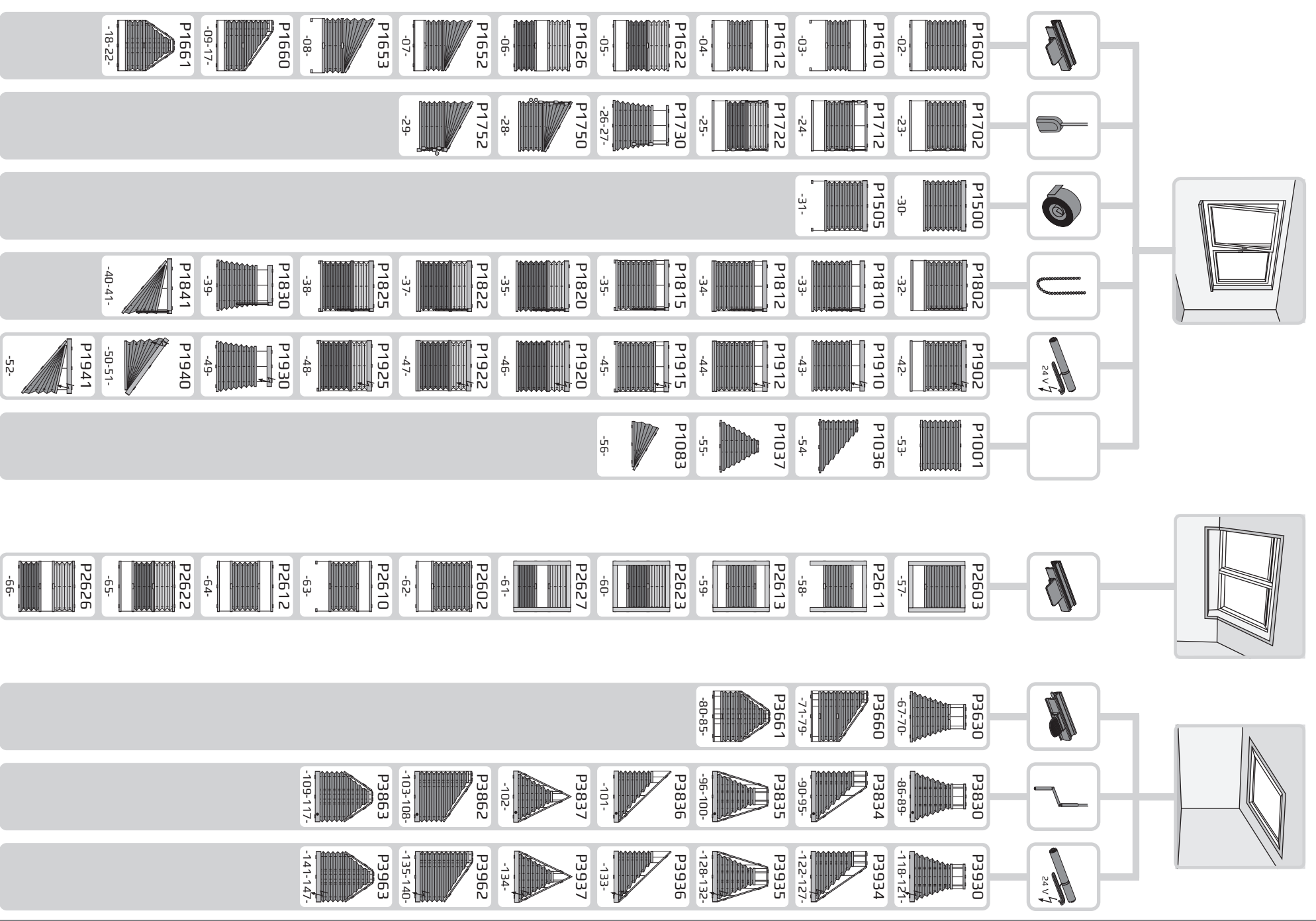

THREADING PLANS . FÄDELPLÄNE . PLANS D'ENFILAGE





P 1602

- 1. Plisseeschnur/Pleating cord/Cordon à plisser Ø0,8 mm
- 2. Plisseeschnur/Pleating cord/Cordon à plisser Ø0,8 mm
- 3. Plisseeschnur/Pleating cord/Cordon à plisser Ø0,8 mm

Federspanner/Spring winder/Tender de ressort

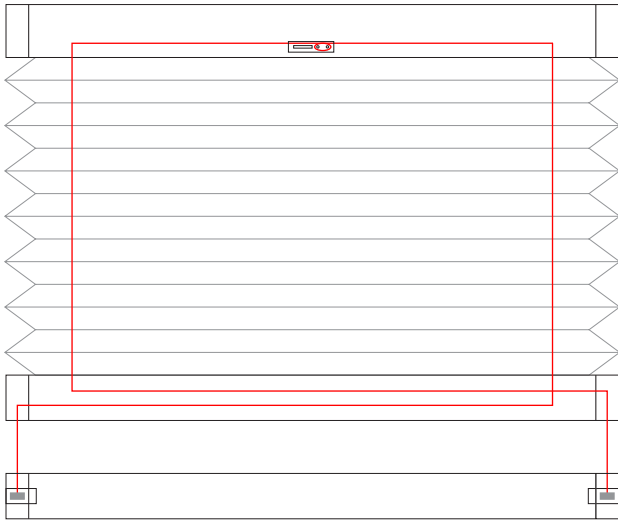

2 Schnurbohrungen/Cord boreholes/Passages de cordon
200-279 mm

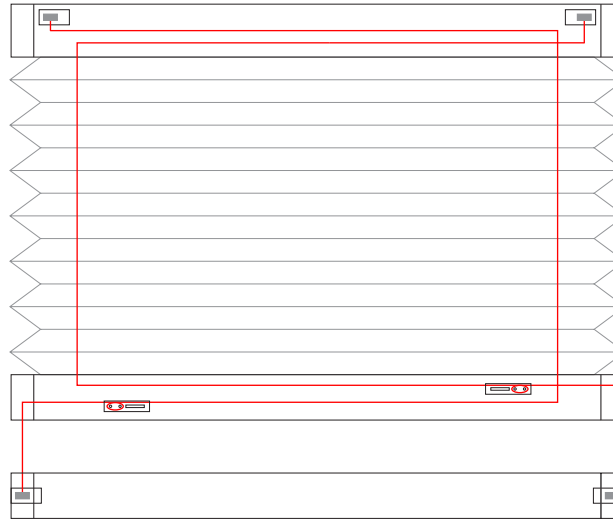

2 Schnurbohrungen/Cord boreholes/Passages de cordon
ab/starting from/à partir de 280 mm

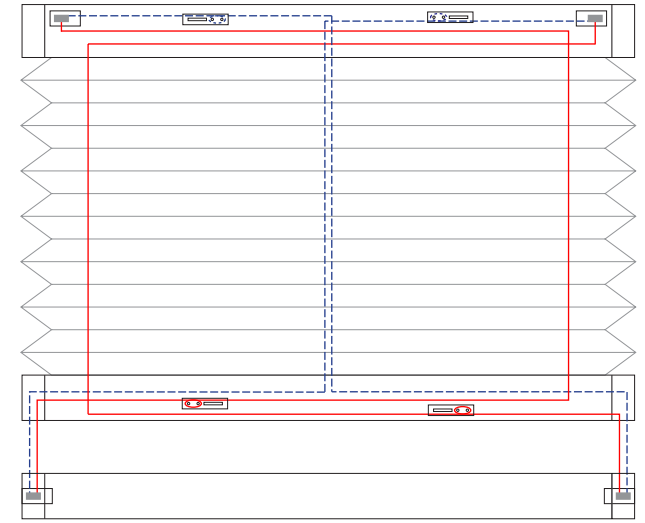

3 Schnurbohrungen/Cord boreholes/Passages de cordon

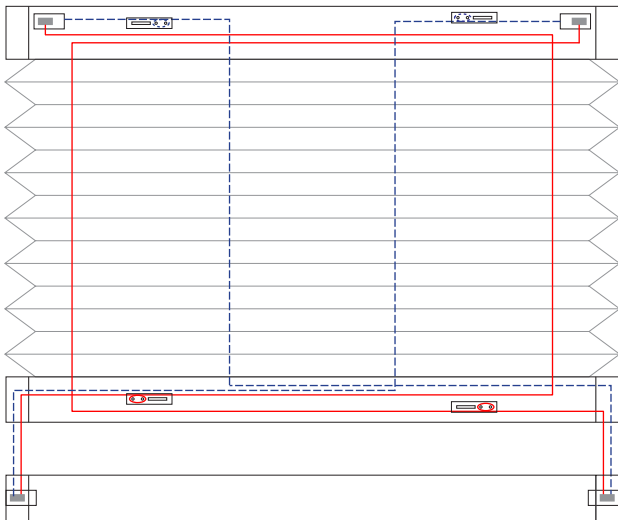

4 Schnurbohrungen/Cord boreholes/Passages de cordon

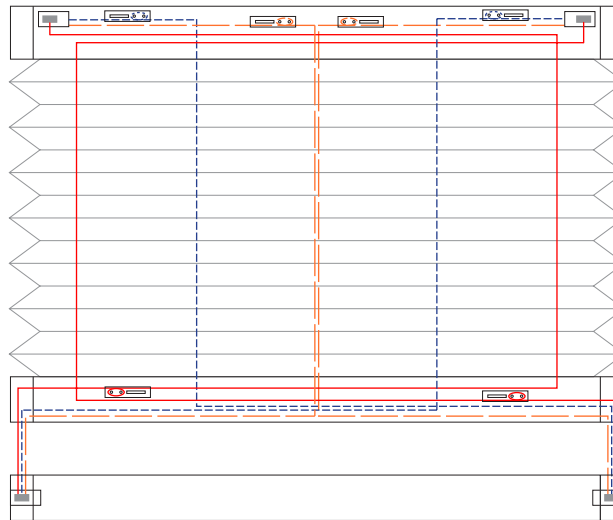

5 Schnurbohrungen/Cord boreholes/Passages de cordon

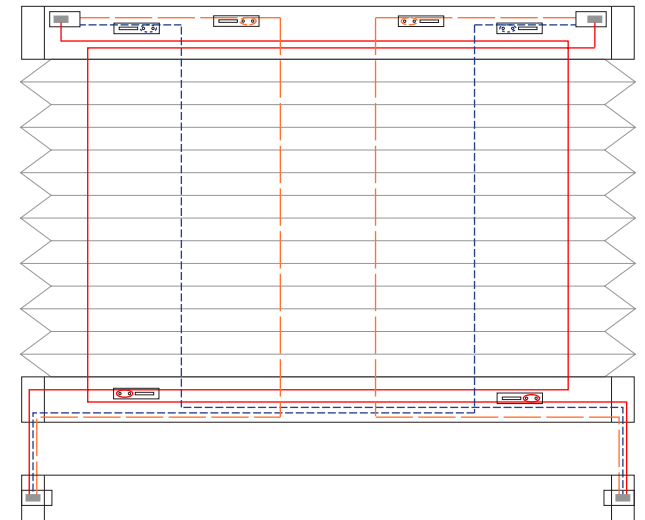

6 Schnurbohrungen/Cord boreholes/Passages de cordon



- 1. Plisseeschnur/Pleating cord/Cordon à plisser Ø0,8 mm
- - - 2. Plisseeschnur/Pleating cord/Cordon à plisser Ø0,8 mm
- 3. Plisseeschnur/Pleating cord/Cordon à plisser Ø0,8 mm

Federspanner/Spring winder/Tender de ressort

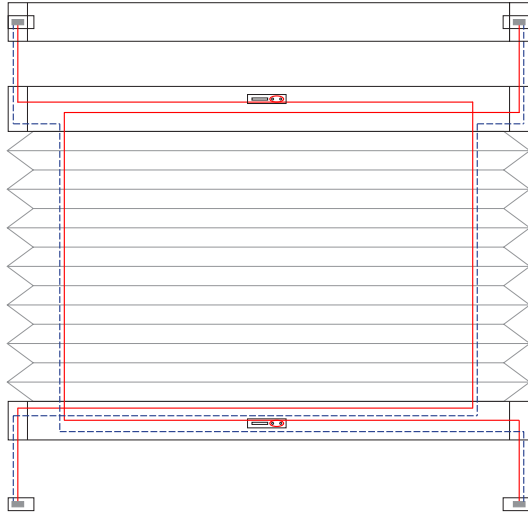

2 Schnurbohrungen/Cord boreholes/Passages de cordon
200-279 mm

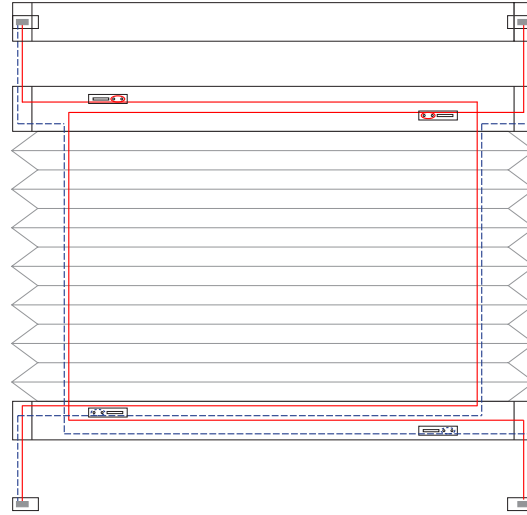

2 Schnurbohrungen/Cord boreholes/Passages de cordon
ab/starting from/à partir de 280 mm

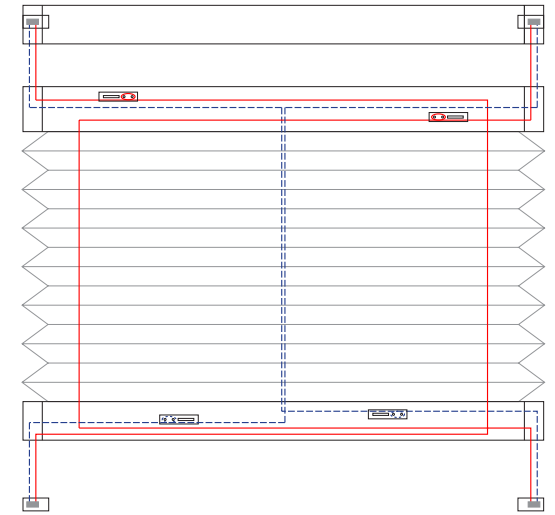

3 Schnurbohrungen/Cord boreholes/Passages de cordon

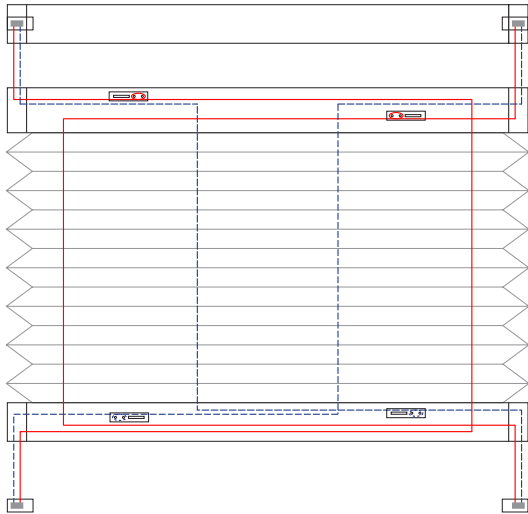

4 Schnurbohrungen/Cord boreholes/Passages de cordon

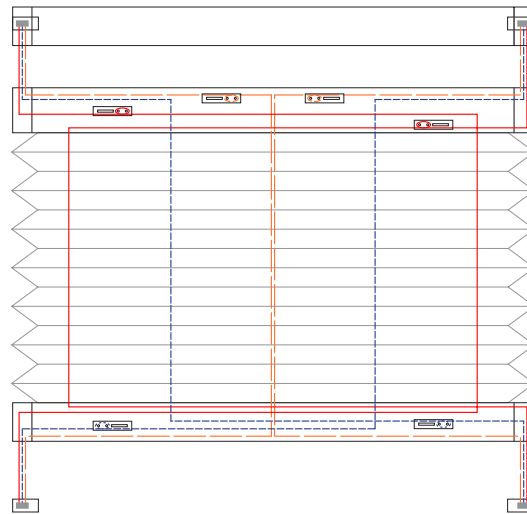

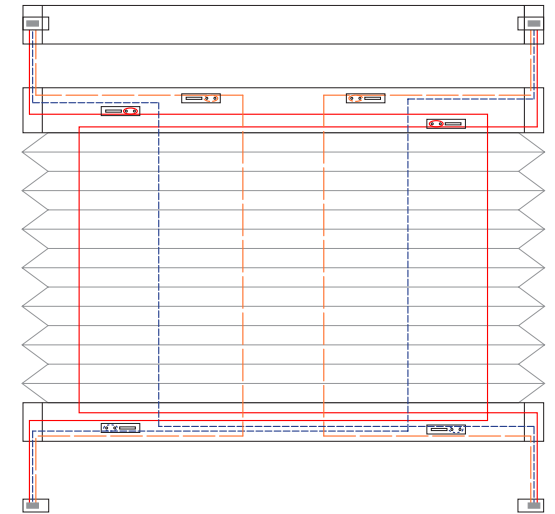

5 Schnurbohrungen/Cord boreholes/Passages de cordon



6 Schnurbohrungen/Cord boreholes/Passages de cordon



P 1612

-  1. Plisseeschnur/Pleating cord/Cordon à plisser Ø0,8 mm
-  2. Plisseeschnur/Pleating cord/Cordon à plisser Ø0,8 mm
-  3. Plisseeschnur/Pleating cord/Cordon à plisser Ø0,8 mm

 Federspanner/Spring winder/Tender de ressort

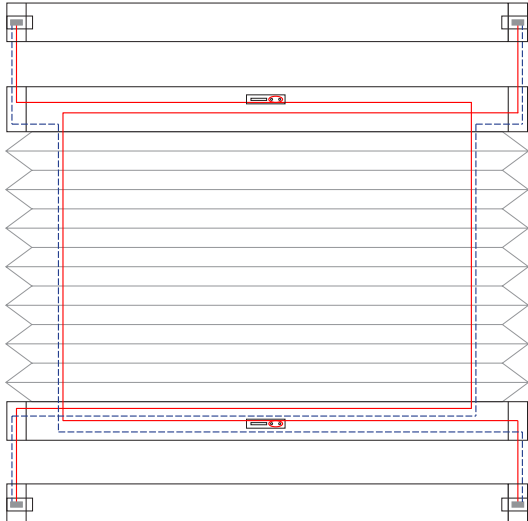

2 Schnurbohrungen/Cord boreholes/Passages de cordon
200-279 mm

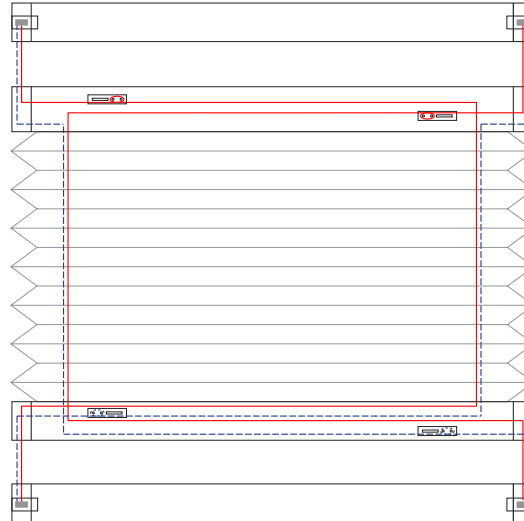

2 Schnurbohrungen/Cord boreholes/Passages de cordon
ab/starting from/à partir de 280 mm

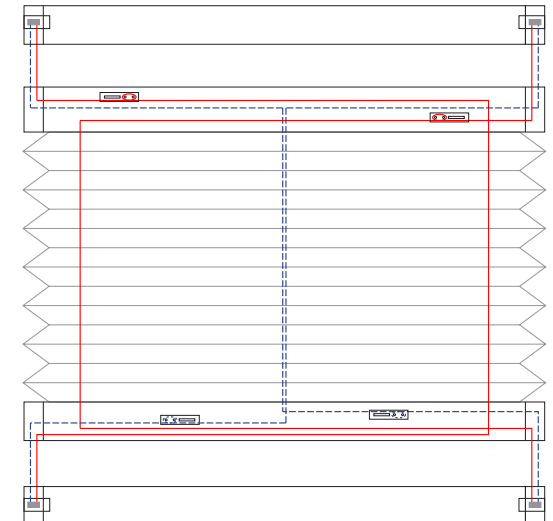

3 Schnurbohrungen/Cord boreholes/Passages de cordon

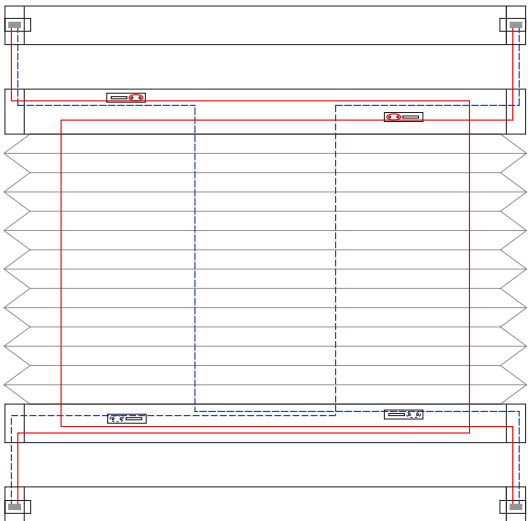

4 Schnurbohrungen/Cord boreholes/Passages de cordon

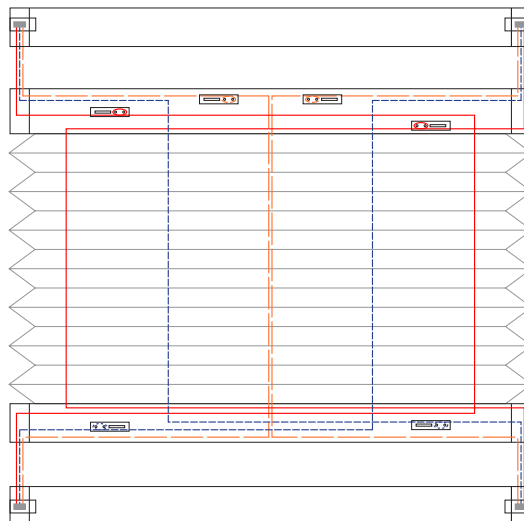

5 Schnurbohrungen/Cord boreholes/Passages de cordon

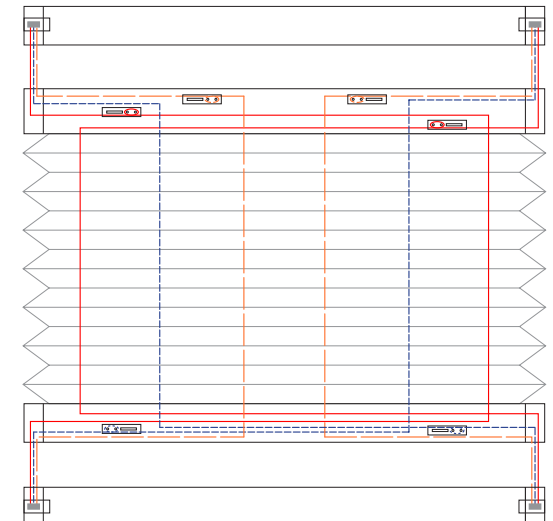

6 Schnurbohrungen/Cord boreholes/Passages de cordon



- 1. Plisseeschnur/Pleating cord/Cordon à plisser Ø0,8 mm
- - - 2. Plisseeschnur/Pleating cord/Cordon à plisser Ø0,8 mm
- 3. Plisseeschnur/Pleating cord/Cordon à plisser Ø0,8 mm
- - - 4. Plisseeschnur/Pleating cord/Cordon à plisser Ø0,8 mm

Federspanner/Spring winder/Tender de ressort

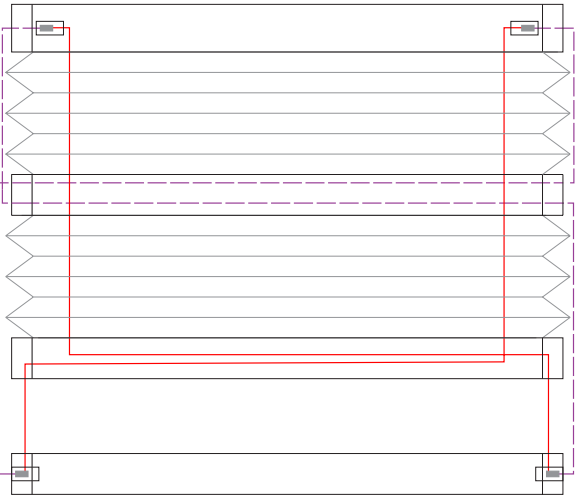

2 Schnurbohrungen/Cord boreholes/Passages de cordon
200-279 mm

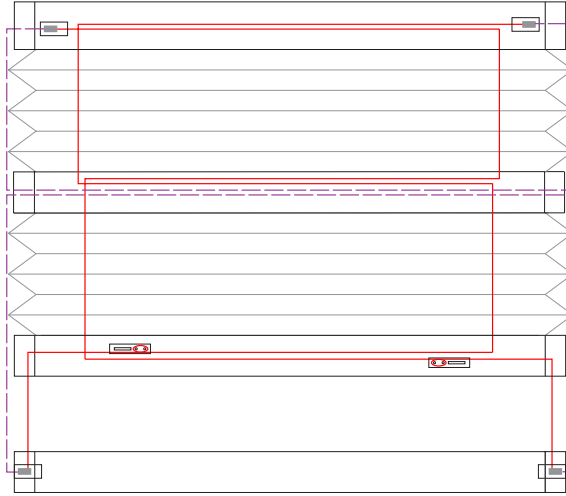

2 Schnurbohrungen/Cord boreholes/Passages de cordon
ab/starting from/à partir de 280 mm

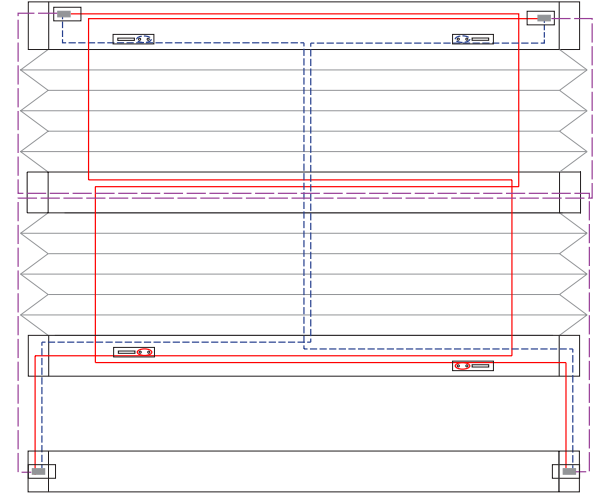

3 Schnurbohrungen/Cord boreholes/Passages de cordon

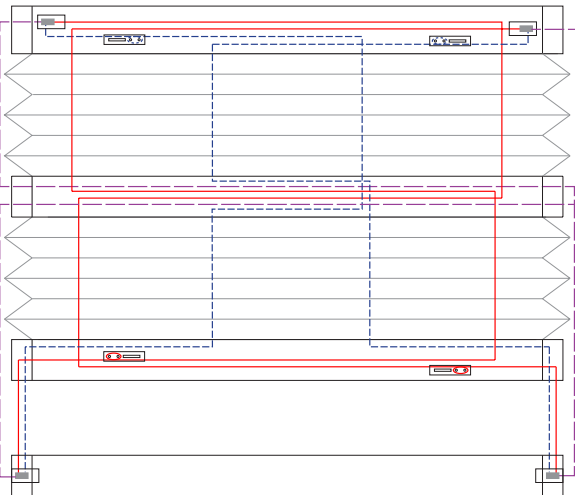

4 Schnurbohrungen/Cord boreholes/Passages de cordon

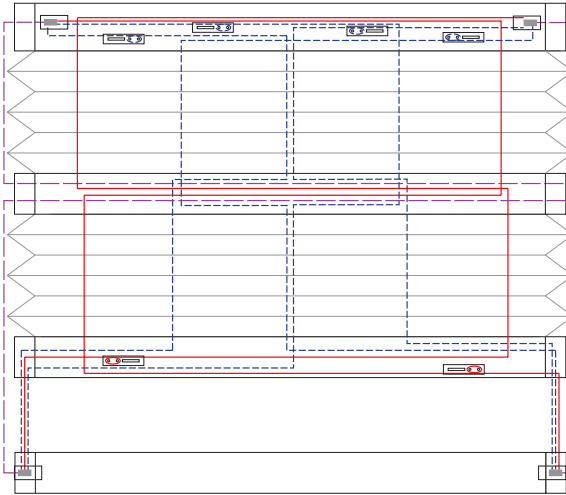

5 Schnurbohrungen/Cord boreholes/Passages de cordon

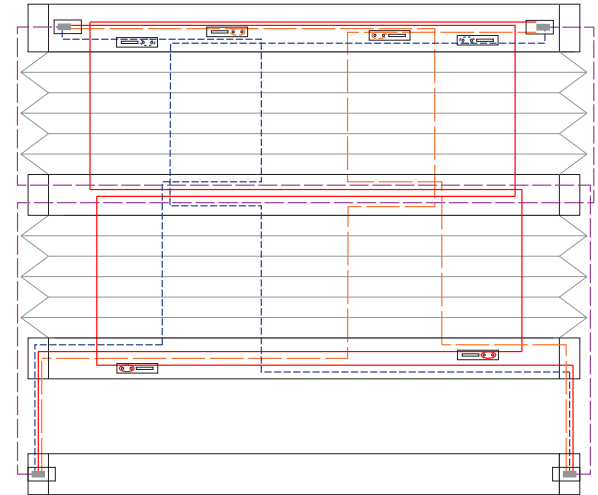

6 Schnurbohrungen/Cord boreholes/Passages de cordon



P 1626

- 1. Plisseeschnur/Pleating cord/Cordon à plisser Ø0,8 mm
- - - 2. Plisseeschnur/Pleating cord/Cordon à plisser Ø0,8 mm
- · - 3. Plisseeschnur/Pleating cord/Cordon à plisser Ø0,8 mm

Federspanner/Spring winder/Tender de ressort

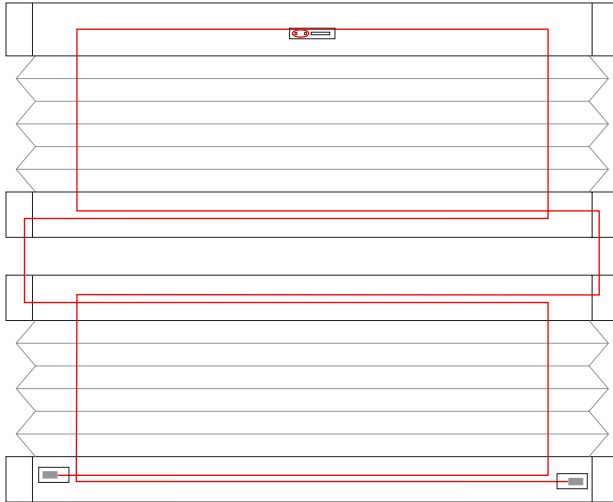

2 Schnurbohrungen/Cord boreholes/Passages de cordon
200-279 mm

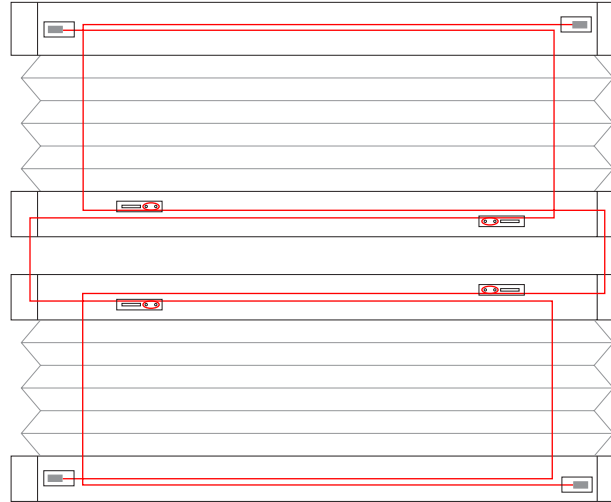

2 Schnurbohrungen/Cord boreholes/Passages de cordon
ab/starting from/à partir de 280 mm



3 Schnurbohrungen/Cord boreholes/Passages de cordon

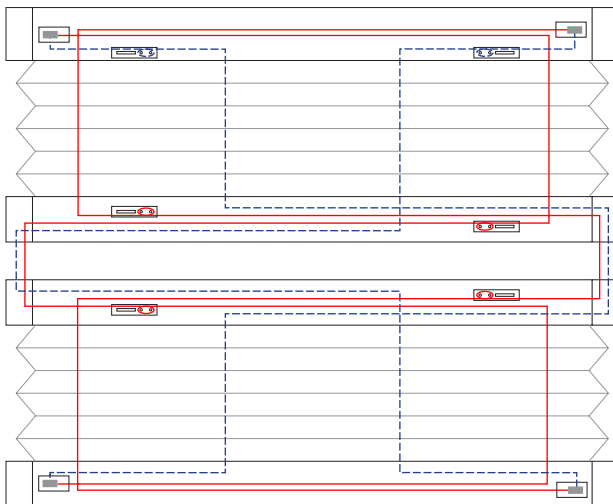

4 Schnurbohrungen/Cord boreholes/Passages de cordon

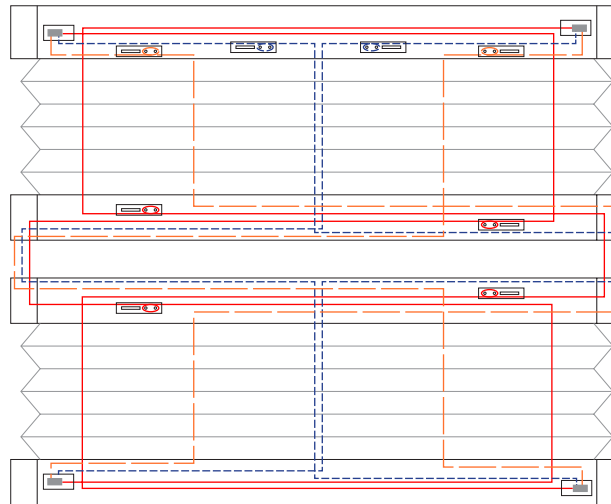





5 Schnurbohrungen/Cord boreholes/Passages de cordon



6 Schnurbohrungen/Cord boreholes/Passages de cordon



P 1652

-  1. Plisseeschnur/Pleating cord/Cordon à plisser Ø0,8 mm
-  2. Plisseeschnur/Pleating cord/Cordon à plisser Ø0,8 mm
-  3. Plisseeschnur/Pleating cord/Cordon à plisser Ø0,8 mm
-  4. Plisseeschnur/Pleating cord/Cordon à plisser Ø0,8 mm



Federspanner/Spring winder/Tendeur de ressort



Zugfeder/Tension spring/Ressort de traction Ø0,7 x 44 mm



Zugfeder/Tension spring/Ressort de traction Ø0,4 x 44 mm



Schnurspanner/Cord stretcher/Tendeur de cordon

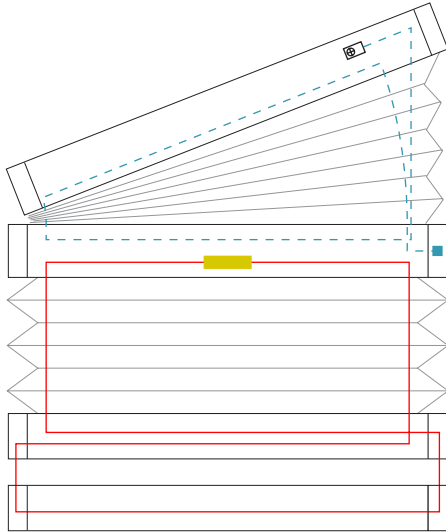

2 Schnurbohrungen/Cord boreholes/Passages de cordon
200-279 mm

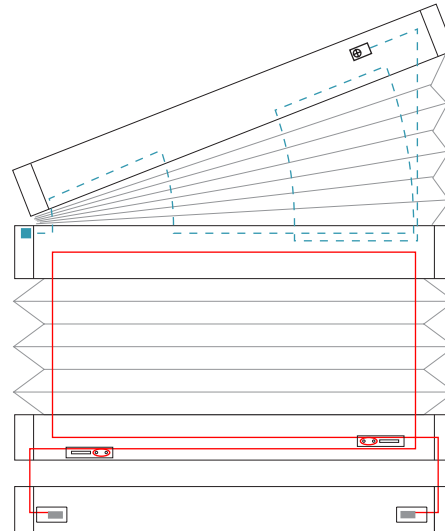

2 Schnurbohrungen/Cord boreholes/Passages de cordon
ab/starting from/à partir de 280 mm

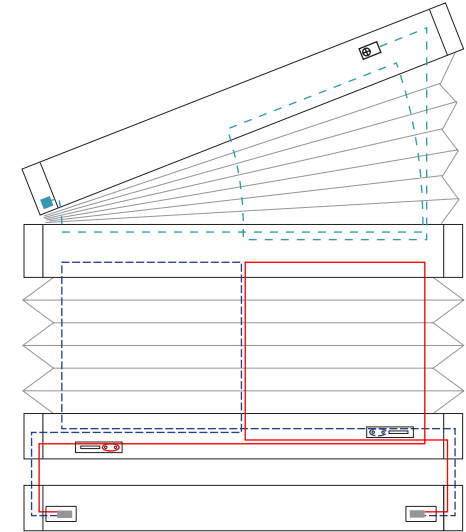

3 Schnurbohrungen/Cord boreholes/Passages de cordon

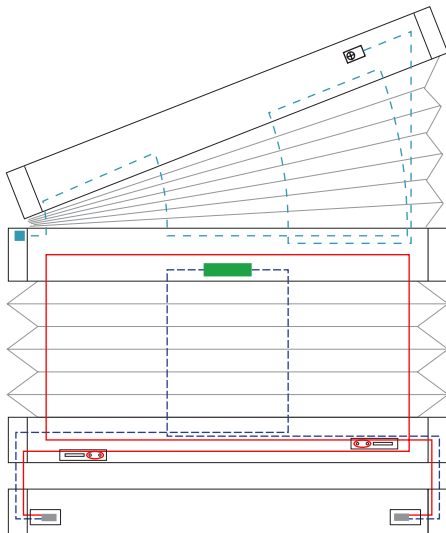

4 Schnurbohrungen/Cord boreholes/Passages de cordon

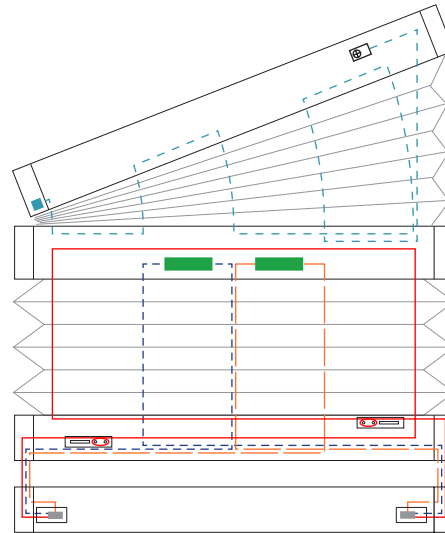

5 Schnurbohrungen/Cord boreholes/Passages de cordon

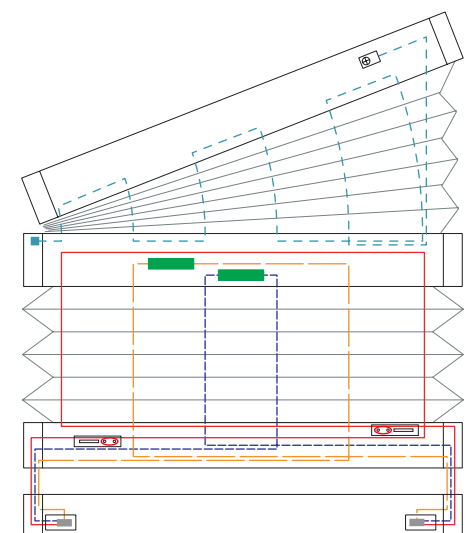

6 Schnurbohrungen/Cord boreholes/Passages de cordon



- 1. Plisseeschnur/Pleating cord/Cordon à plisser Ø0,8 mm
- - - 2. Plisseeschnur/Pleating cord/Cordon à plisser Ø0,8 mm
- - - 3. Plisseeschnur/Pleating cord/Cordon à plisser Ø0,8 mm
- - - 4. Plisseeschnur/Pleating cord/Cordon à plisser Ø0,8 mm

- Federspanner/Spring winder/Tender de ressort
- Zugfeder/Tension spring/Ressort de traction Ø0,4 x 1000 mm
- Zugfeder/Tension spring/Ressort de traction Ø0,4 x 44 mm
- Schnurspanner/Cord stretcher/Tendeur de cordon

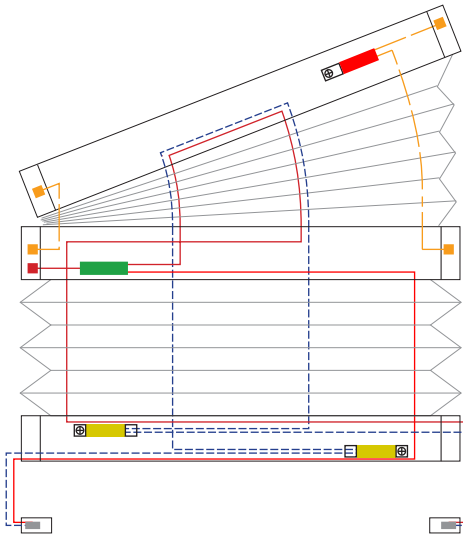

4 Schnurbohrungen/Cord boreholes/Passages de cordon

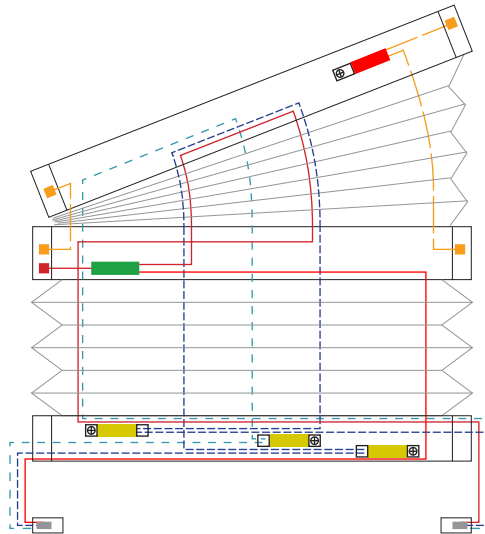

5 Schnurbohrungen/Cord boreholes/Passages de cordon

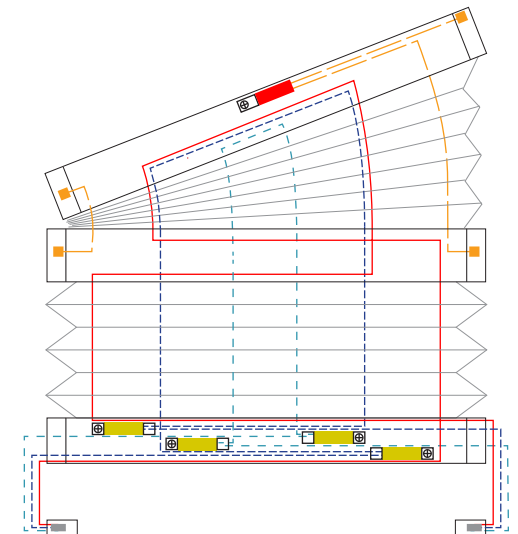

6 Schnurbohrungen/Cord boreholes/Passages de cordon



P 1660-2

- 1. Plisseeschnur/Pleating cord/Cordon à plisser Ø0,8 mm
- - - 2. Plisseeschnur/Pleating cord/Cordon à plisser Ø0,8 mm
- - - 3. Plisseeschnur/Pleating cord/Cordon à plisser Ø0,8 mm
- - - Stoppschnur/Stop cord/Cordon d'arrêt Ø0,8 mm

- - - Gummiband/Rubber band/Ruban en caoutchouc Ø1,25 mm
- Zugfeder/Tension spring/Ressort de traction Ø0,4 x 44 mm
- Zugfeder/Tension spring/Ressort de traction Ø0,7 x 44 mm

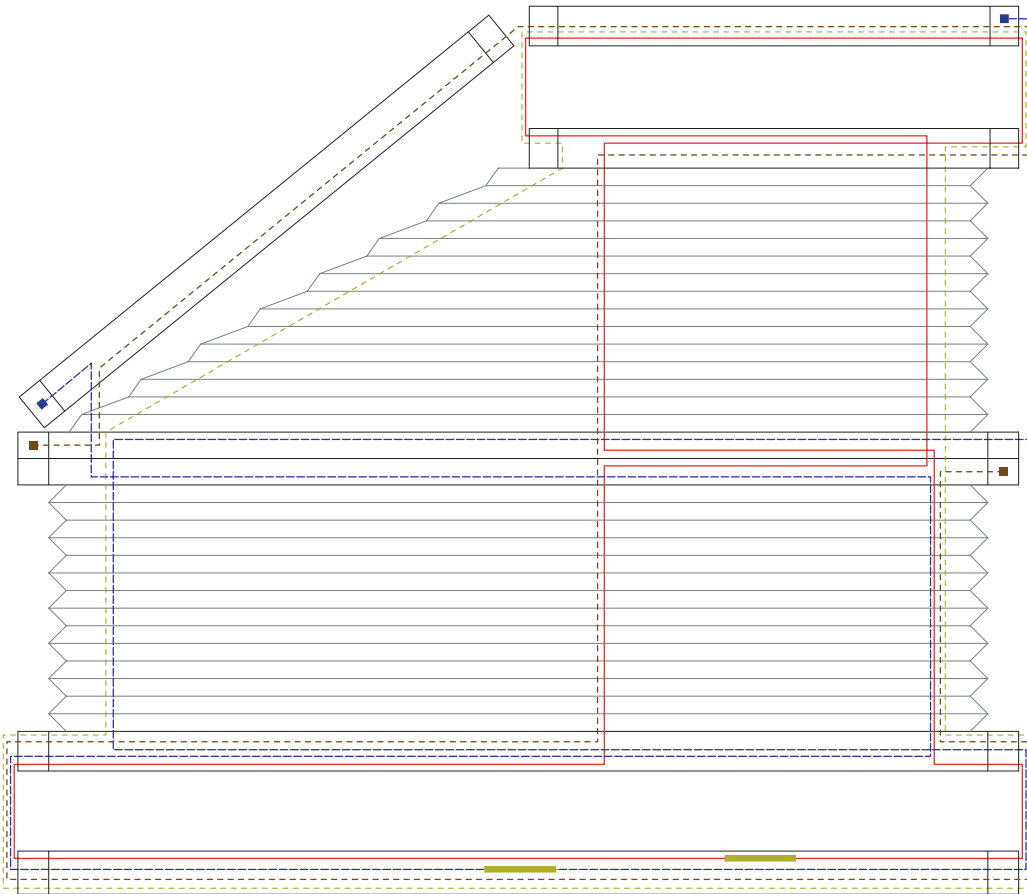

3 Schnurbohrungen/Cord boreholes/Passages de cordon

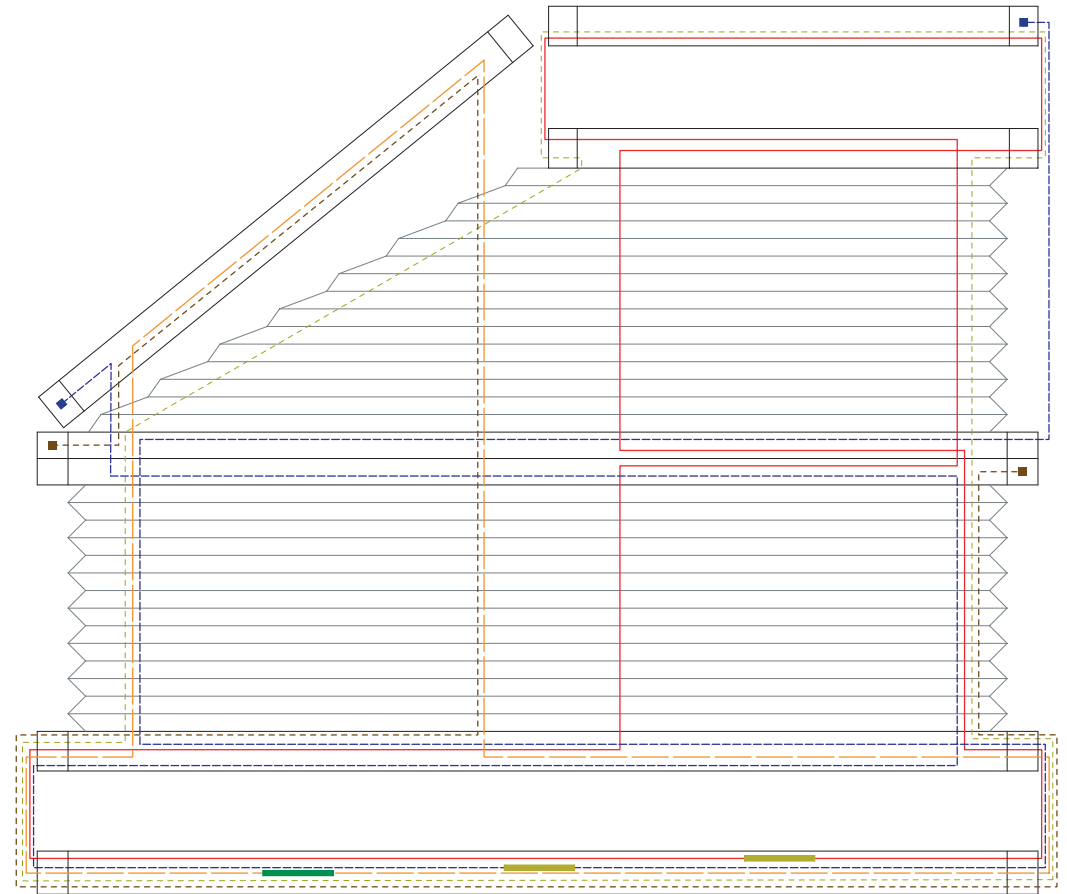

4 Schnurbohrungen/Cord boreholes/Passages de cordon



P 1660-2

- 1. Plisseeschnur/Pleating cord/Cordon à plisser Ø0,8 mm
- - - 2. Plisseeschnur/Pleating cord/Cordon à plisser Ø0,8 mm
- - - 3. Plisseeschnur/Pleating cord/Cordon à plisser Ø0,8 mm
- - - 4. Plisseeschnur/Pleating cord/Cordon à plisser Ø0,8 mm

- - - Stoppschnur/Stop cord/Cordon d'arrêt Ø0,8 mm
- - - Gummiband/Rubber band/Ruban en caoutchouc Ø1,25 mm
- Zugfeder/Tension spring/Ressort de traction Ø0,4 x 44 mm
- Zugfeder/Tension spring/Ressort de traction Ø0,7 x 44 mm

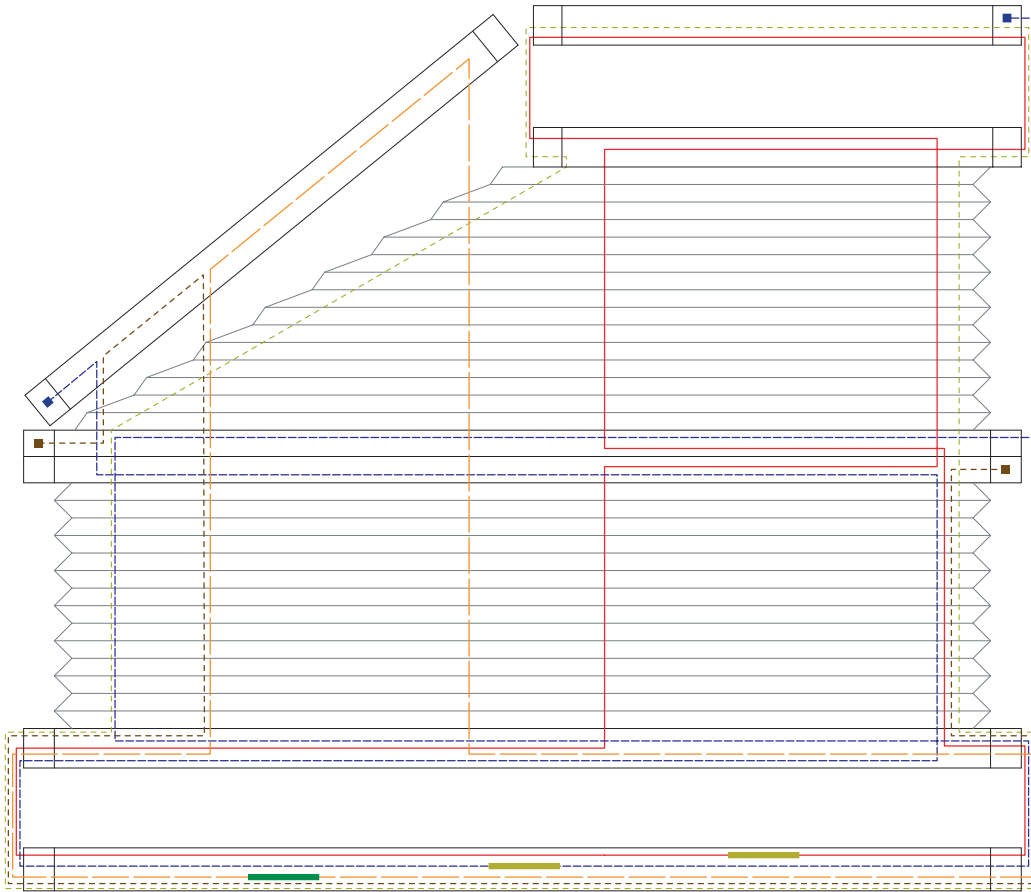

5 Schnurbohrungen/Cord boreholes/Passages de cordon

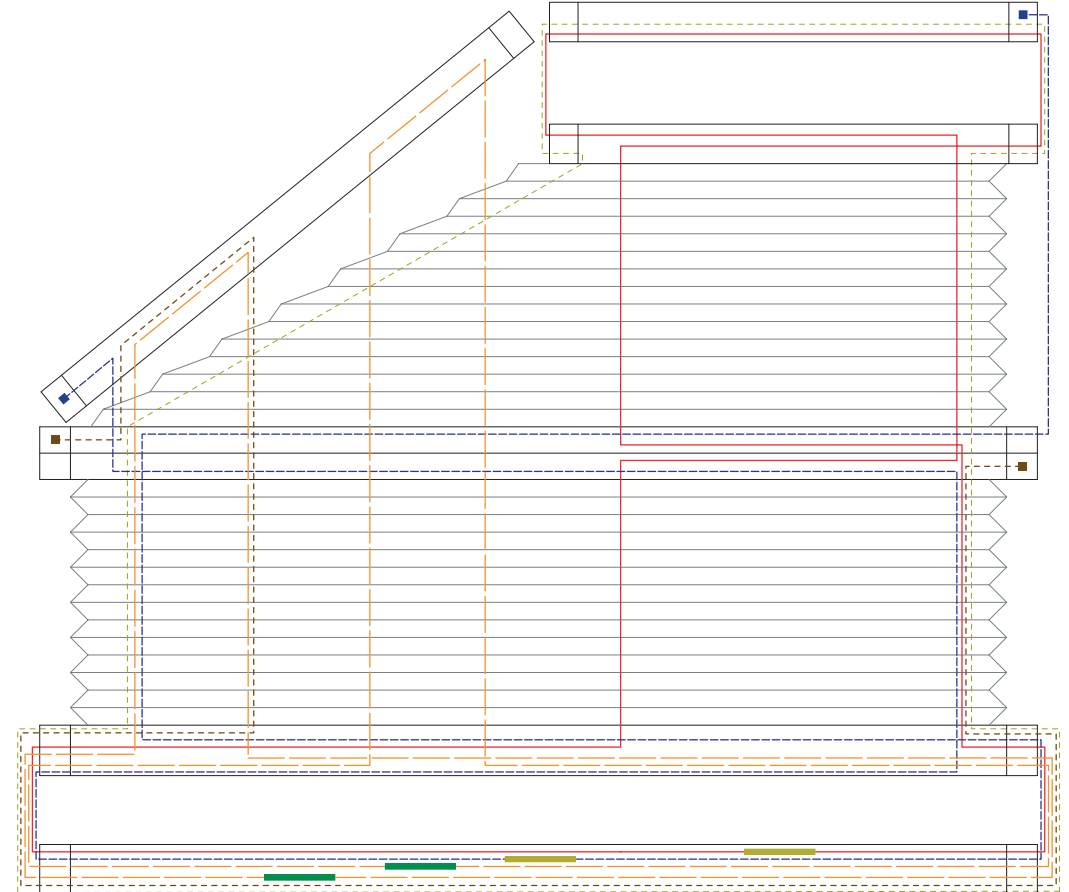

6 Schnurbohrungen/Cord boreholes/Passages de cordon



P 1660-2

- 1. Plisseeschnur/Pleating cord/Cordon à plisser Ø0,8 mm
- - - 2. Plisseeschnur/Pleating cord/Cordon à plisser Ø0,8 mm
- - - 3. Plisseeschnur/Pleating cord/Cordon à plisser Ø0,8 mm
- - - 4. Plisseeschnur/Pleating cord/Cordon à plisser Ø0,8 mm

- - - Stoppschnur/Stop cord/Cordon d'arrêt Ø0,8 mm
- - - Gummiband/Rubber band/Ruban en caoutchouc Ø1,25 mm
- Zugfeder/Tension spring/Ressort de traction Ø0,4 x 44 mm
- Zugfeder/Tension spring/Ressort de traction Ø0,7 x 44 mm

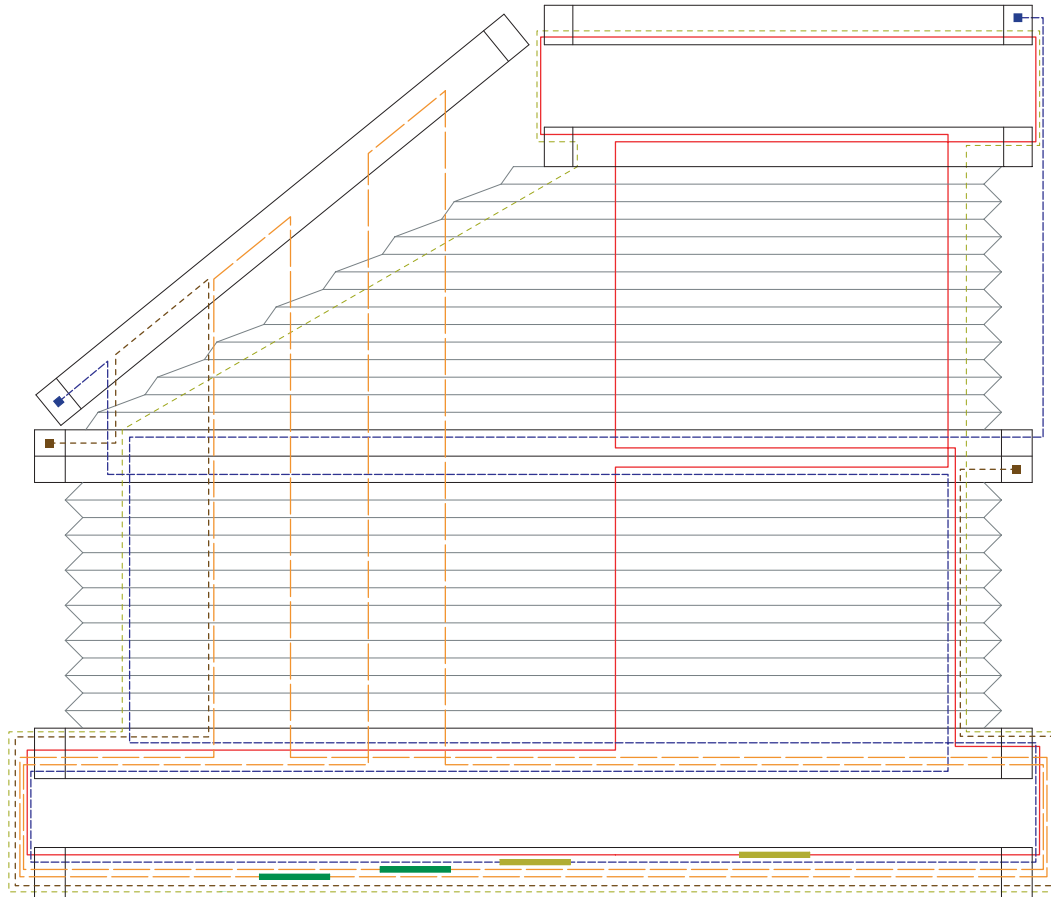

7 Schnurbohrungen/Cord boreholes/Passages de cordon



P 1660-3

- 1. Plisseeschnur/Pleating cord/Cordon à plisser Ø0,8 mm
- - - 2. Plisseeschnur/Pleating cord/Cordon à plisser Ø0,8 mm
- - - 3. Plisseeschnur/Pleating cord/Cordon à plisser Ø0,8 mm
- - - 4. Plisseeschnur/Pleating cord/Cordon à plisser Ø0,8 mm

- - - Stoppschnur/Stop cord/Cordon d'arrêt Ø0,8 mm
- - - Gummiband/Rubber band/Ruban en caoutchouc Ø1,25 mm
- Zugfeder/Tension spring/Ressort de traction Ø0,4 x 44 mm
- Zugfeder/Tension spring/Ressort de traction Ø0,7 x 44 mm

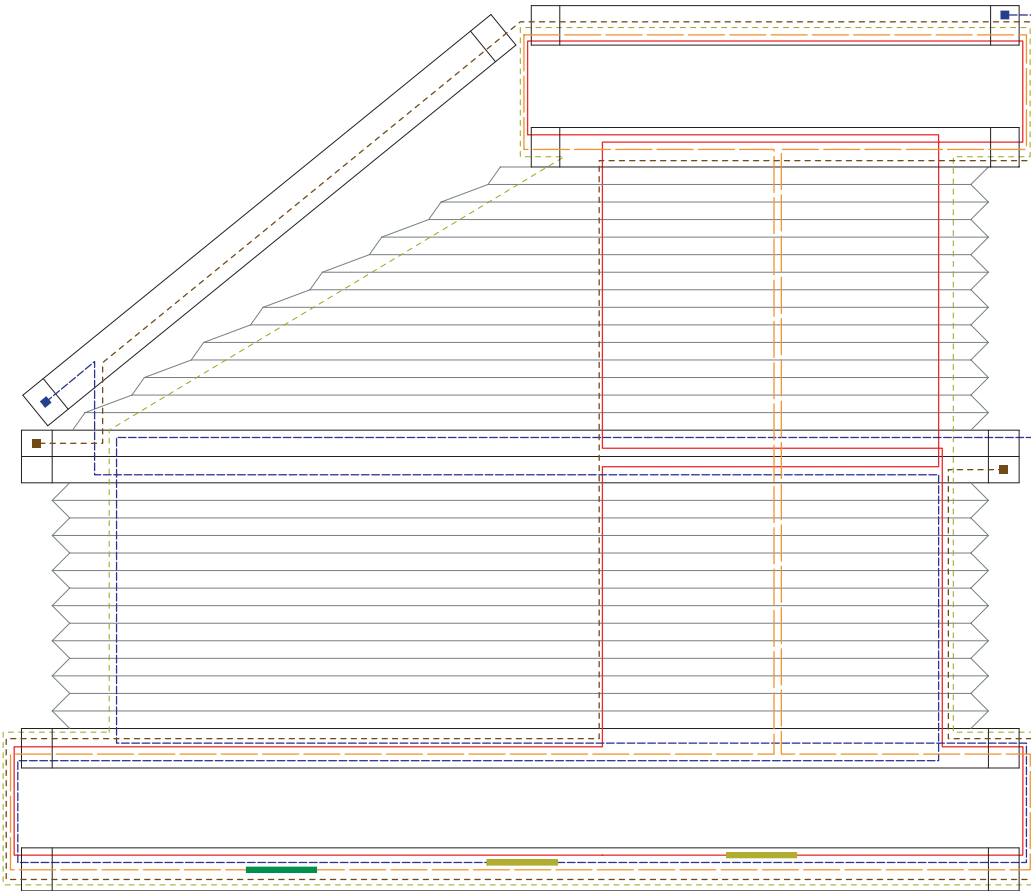

4 Schnurbohrungen/Cord boreholes/Passages de cordon

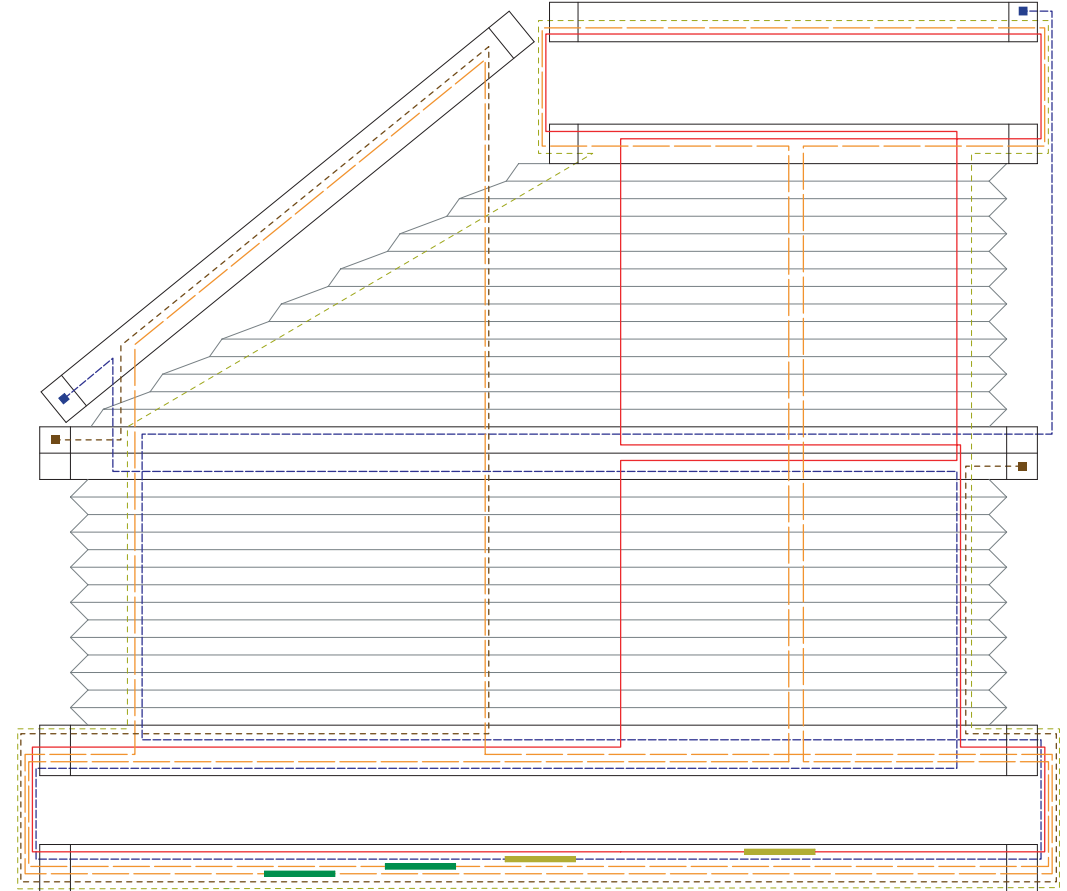

5 Schnurbohrungen/Cord boreholes/Passages de cordon



P 1660-3

- 1. Plisseeschnur/Pleating cord/Cordon à plisser Ø0,8 mm
- - - 2. Plisseeschnur/Pleating cord/Cordon à plisser Ø0,8 mm
- 3. Plisseeschnur/Pleating cord/Cordon à plisser Ø0,8 mm
- - - 4. Plisseeschnur/Pleating cord/Cordon à plisser Ø0,8 mm
- - - 5. Plisseeschnur/Pleating cord/Cordon à plisser Ø0,8 mm

- - - Stoppschnur/Stop cord/Cordon d'arrêt Ø0,8 mm
- - - Gummiband/Rubber band/Ruban en caoutchouc Ø1,25 mm
- Zugfeder/Tension spring/Ressort de traction Ø0,4 x 44 mm
- Zugfeder/Tension spring/Ressort de traction Ø0,7 x 44 mm

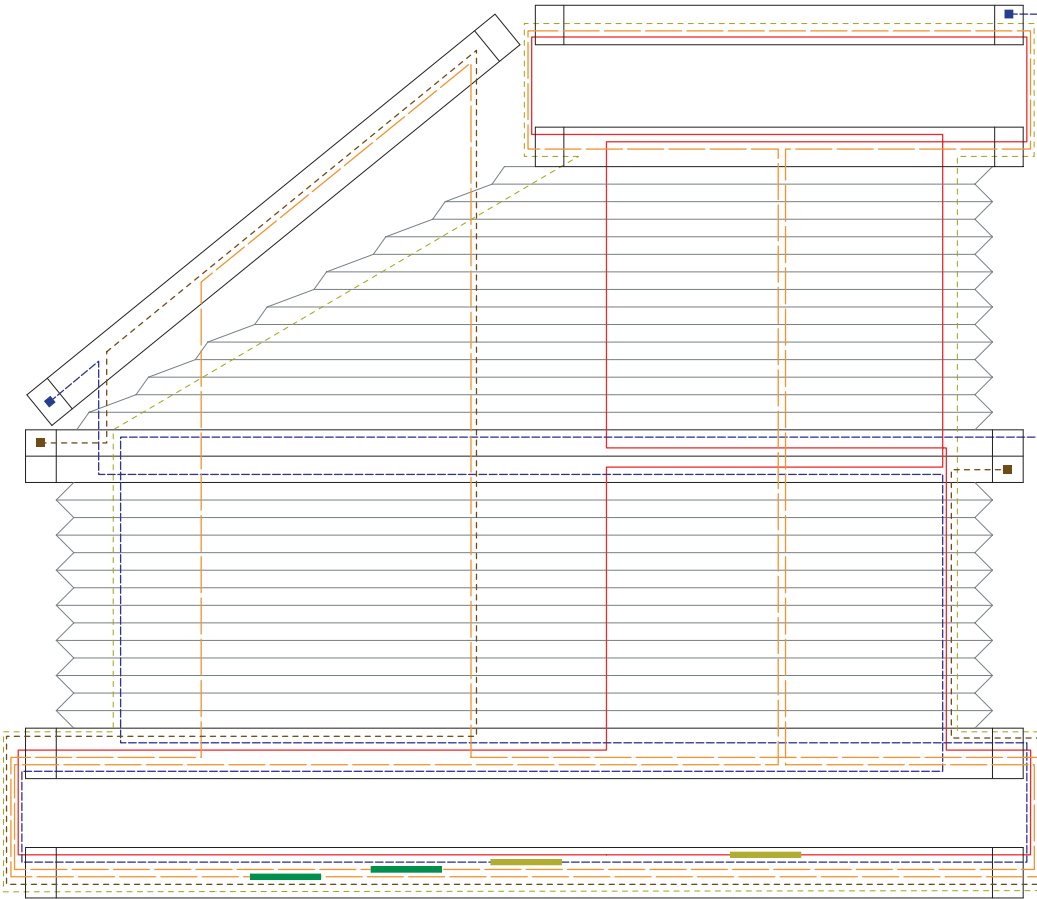

6 Schnurbohrungen/Cord boreholes/Passages de cordon

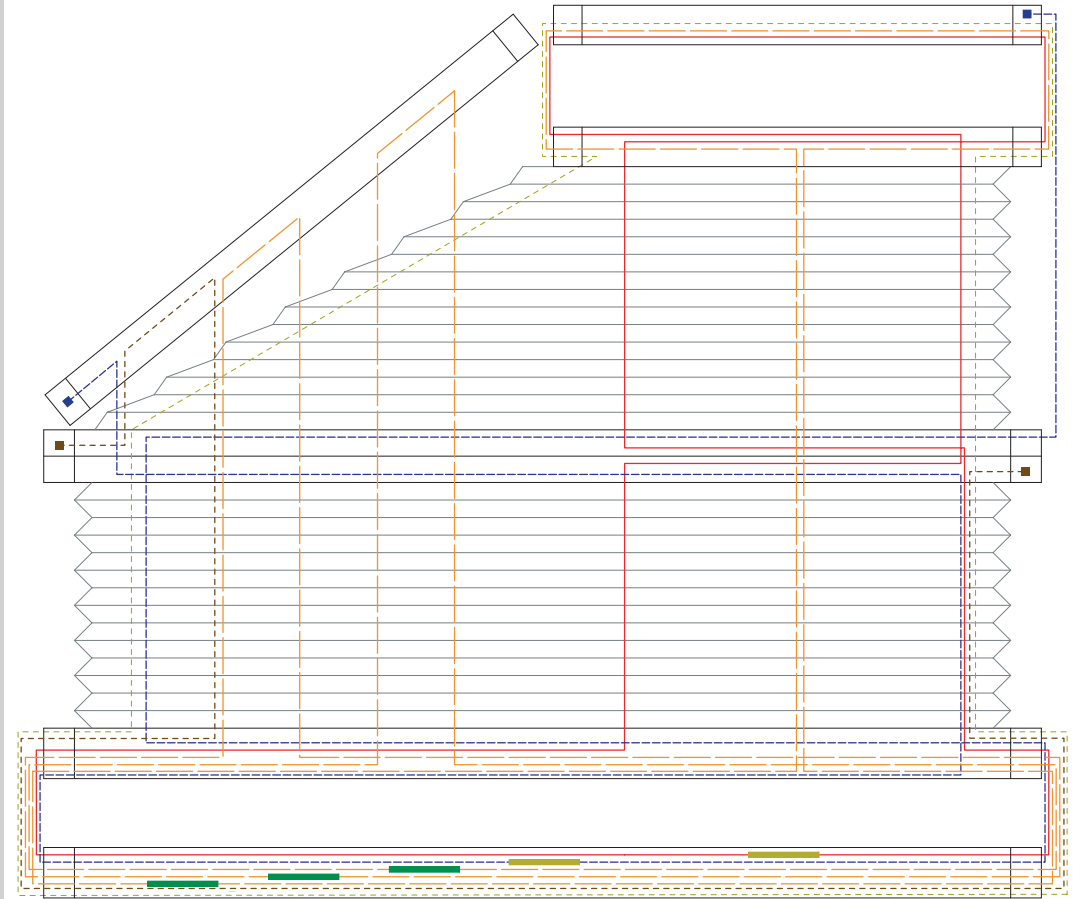

7 Schnurbohrungen/Cord boreholes/Passages de cordon



P 1660-4

- 1. Plisseeschnur/Pleating cord/Cordon à plisser Ø0,8 mm
- - - 2. Plisseeschnur/Pleating cord/Cordon à plisser Ø0,8 mm
- - - 3. Plisseeschnur/Pleating cord/Cordon à plisser Ø0,8 mm
- - - 4. Plisseeschnur/Pleating cord/Cordon à plisser Ø0,8 mm

- - - Stoppschnur/Stop cord/Cordon d'arrêt Ø0,8 mm
- - - Gummiband/Rubber band/Ruban en caoutchouc Ø1,25 mm
- Zugfeder/Tension spring/Ressort de traction Ø0,4 x 44 mm
- Zugfeder/Tension spring/Ressort de traction Ø0,7 x 44 mm

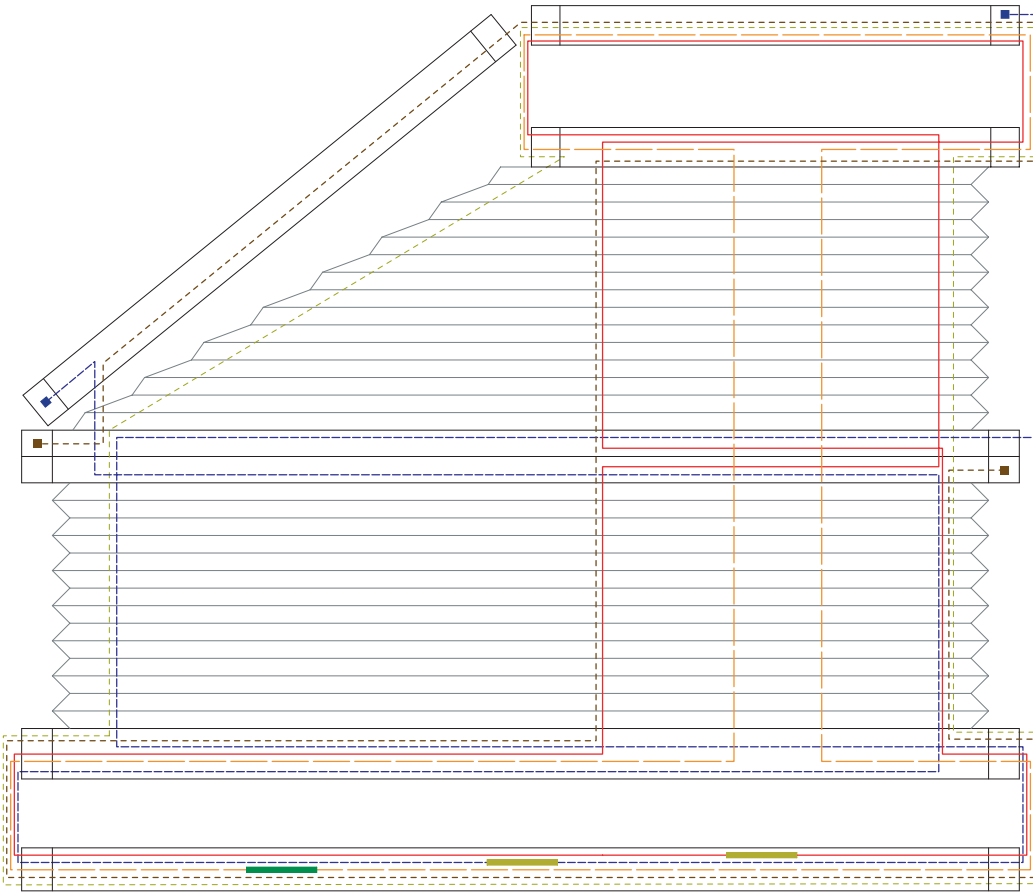

5 Schnurbohrungen/Cord boreholes/Passages de cordon

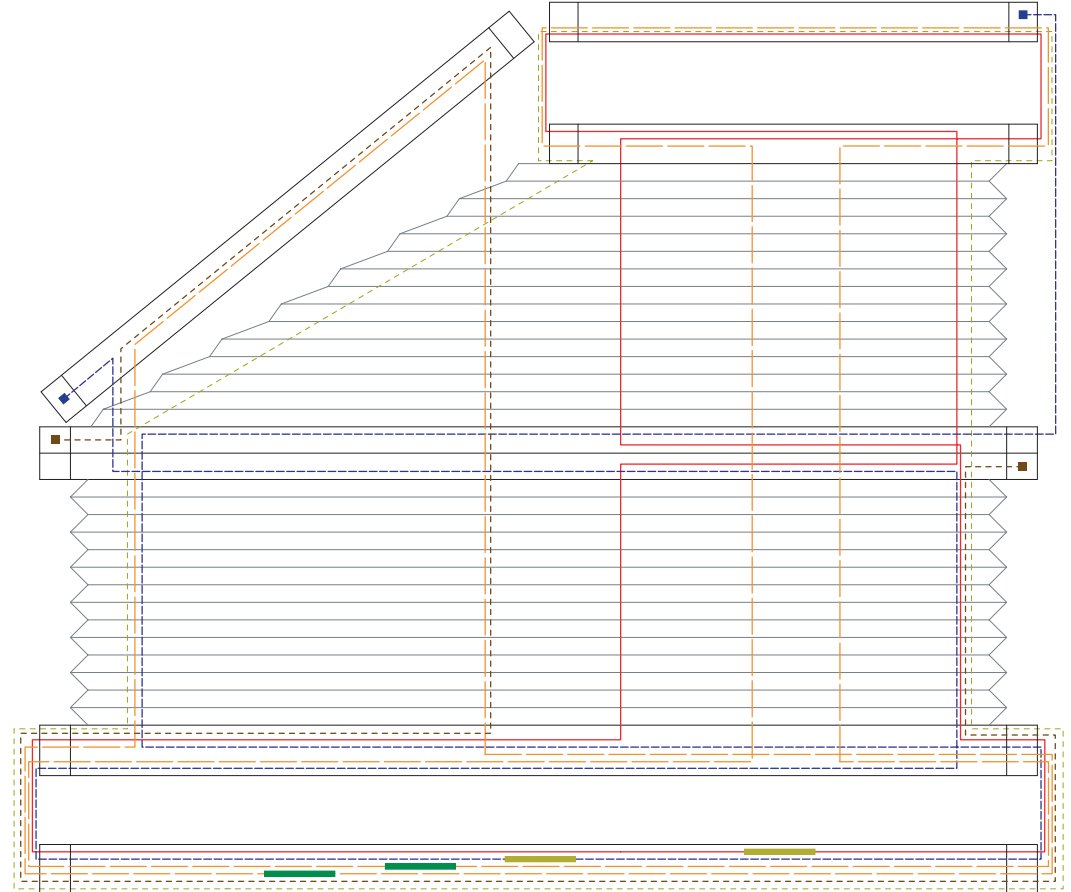

6 Schnurbohrungen/Cord boreholes/Passages de cordon



P 1660-4

- 1. Plisseeschnur/Pleating cord/Cordon à plisser Ø0,8 mm
- - - 2. Plisseeschnur/Pleating cord/Cordon à plisser Ø0,8 mm
- 3. Plisseeschnur/Pleating cord/Cordon à plisser Ø0,8 mm
- - - 4. Plisseeschnur/Pleating cord/Cordon à plisser Ø0,8 mm
- - - 5. Plisseeschnur/Pleating cord/Cordon à plisser Ø0,8 mm

- - - Stoppschnur/Stop cord/Cordon d'arrêt Ø0,8 mm
- - - Gummiband/Rubber band/Ruban en caoutchouc Ø1,25 mm
- Zugfeder/Tension spring/Ressort de traction Ø0,4 x 44 mm
- Zugfeder/Tension spring/Ressort de traction Ø0,7 x 44 mm

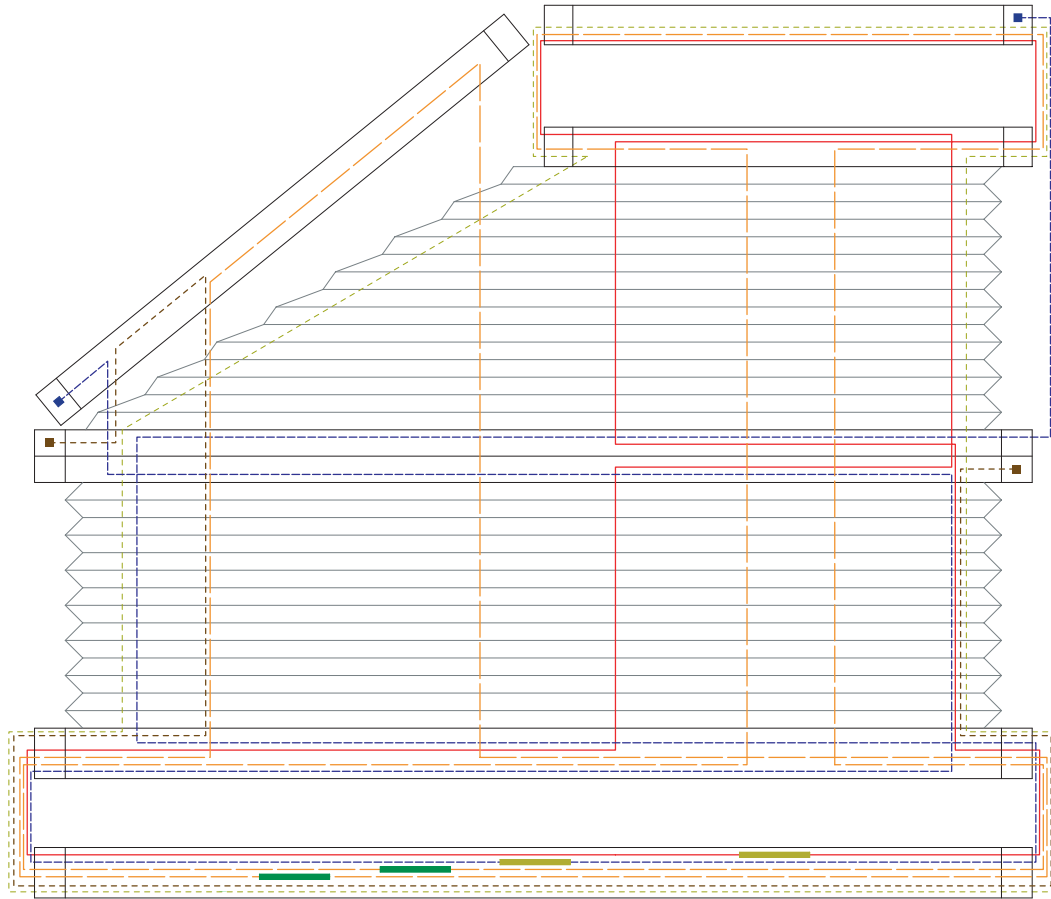

7 Schnurbohrungen/Cord boreholes/Passages de cordon



P 1660-5

- 1. Plisseeschnur/Pleating cord/Cordon à plisser Ø0,8 mm
- - - 2. Plisseeschnur/Pleating cord/Cordon à plisser Ø0,8 mm
- 3. Plisseeschnur/Pleating cord/Cordon à plisser Ø0,8 mm
- 4. Plisseeschnur/Pleating cord/Cordon à plisser Ø0,8 mm
- - - 5. Plisseeschnur/Pleating cord/Cordon à plisser Ø0,8 mm

- - - - Stoppschnur/Stop cord/Cordon d'arrêt Ø0,8 mm
- - - - Gummiband/Rubber band/Ruban en caoutchouc Ø1,25 mm
- Zugfeder/Tension spring/Ressort de traction Ø0,4 x 44 mm
- Zugfeder/Tension spring/Ressort de traction Ø0,7 x 44 mm

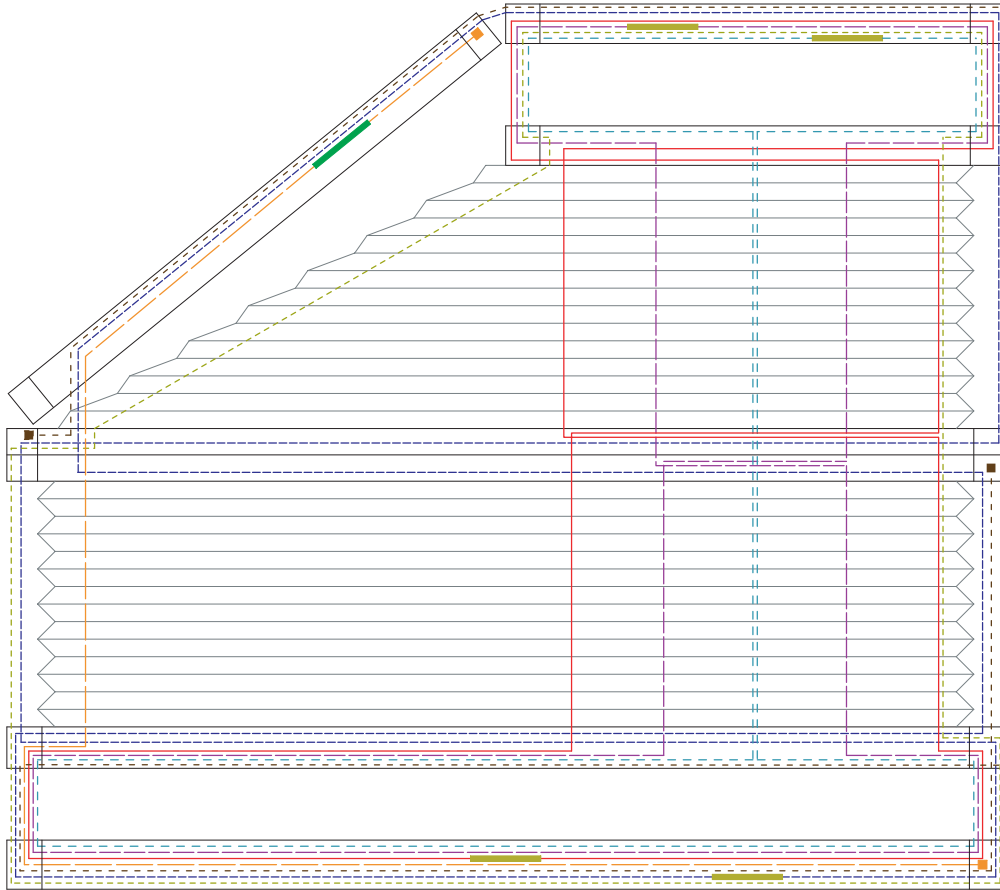

6 Schnurbohrungen/Cord boreholes/Passages de cordon

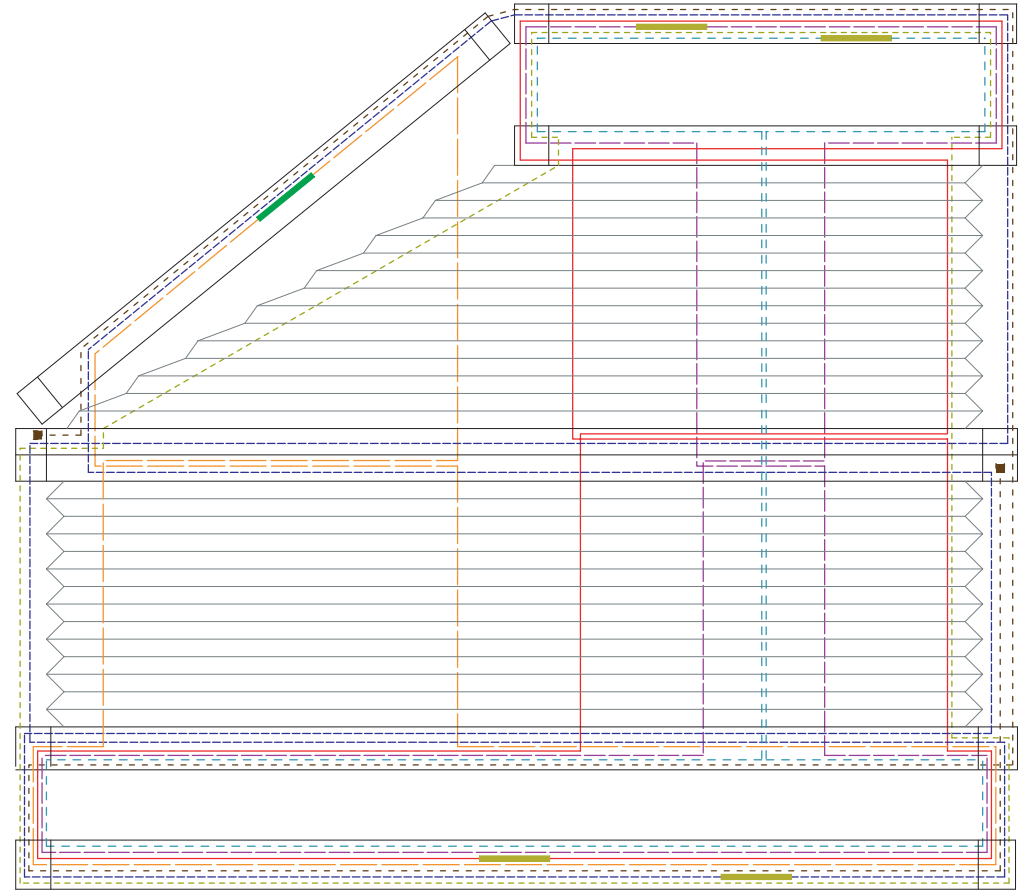

7 Schnurbohrungen/Cord boreholes/Passages de cordon



P 1660-6

- 1. Plisseeschnur/Pleating cord/Cordon à plisser Ø0,8 mm
- - - 2. Plisseeschnur/Pleating cord/Cordon à plisser Ø0,8 mm
- 3. Plisseeschnur/Pleating cord/Cordon à plisser Ø0,8 mm
- - - 4. Plisseeschnur/Pleating cord/Cordon à plisser Ø0,8 mm
- - - 5. Plisseeschnur/Pleating cord/Cordon à plisser Ø0,8 mm

- - - Stoppschnur/Stop cord/Cordon d'arrêt Ø0,8 mm
- - - Gummiband/Rubber band/Ruban en caoutchouc Ø1,25 mm
- Zugfeder/Tension spring/Ressort de traction Ø0,4 x 44 mm
- Zugfeder/Tension spring/Ressort de traction Ø0,7 x 44 mm

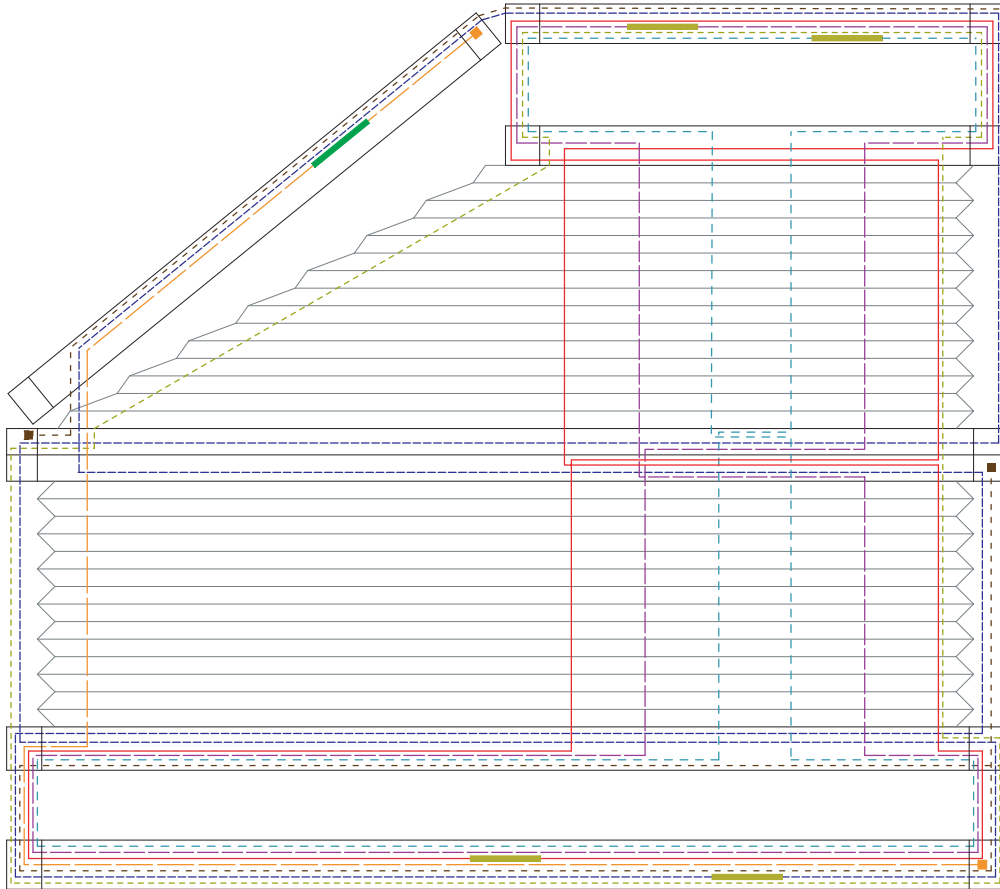

7 Schnurbohrungen/Cord boreholes/Passages de cordon



- 1. Plisseeschnur/Pleating cord/Cordon à plisser Ø0,8 mm
- - - 2. Plisseeschnur/Pleating cord/Cordon à plisser Ø0,8 mm
- - - 3. Plisseeschnur/Pleating cord/Cordon à plisser Ø0,8 mm
- - - 4. Plisseeschnur/Pleating cord/Cordon à plisser Ø0,8 mm

- - - Gummiband/Rubber band/Ruban en caoutchouc Ø1,25 mm
- Zugfeder/Tension spring/Ressort de traction Ø0,4 x 44 mm
- Zugfeder/Tension spring/Ressort de traction Ø0,7 x 44 mm

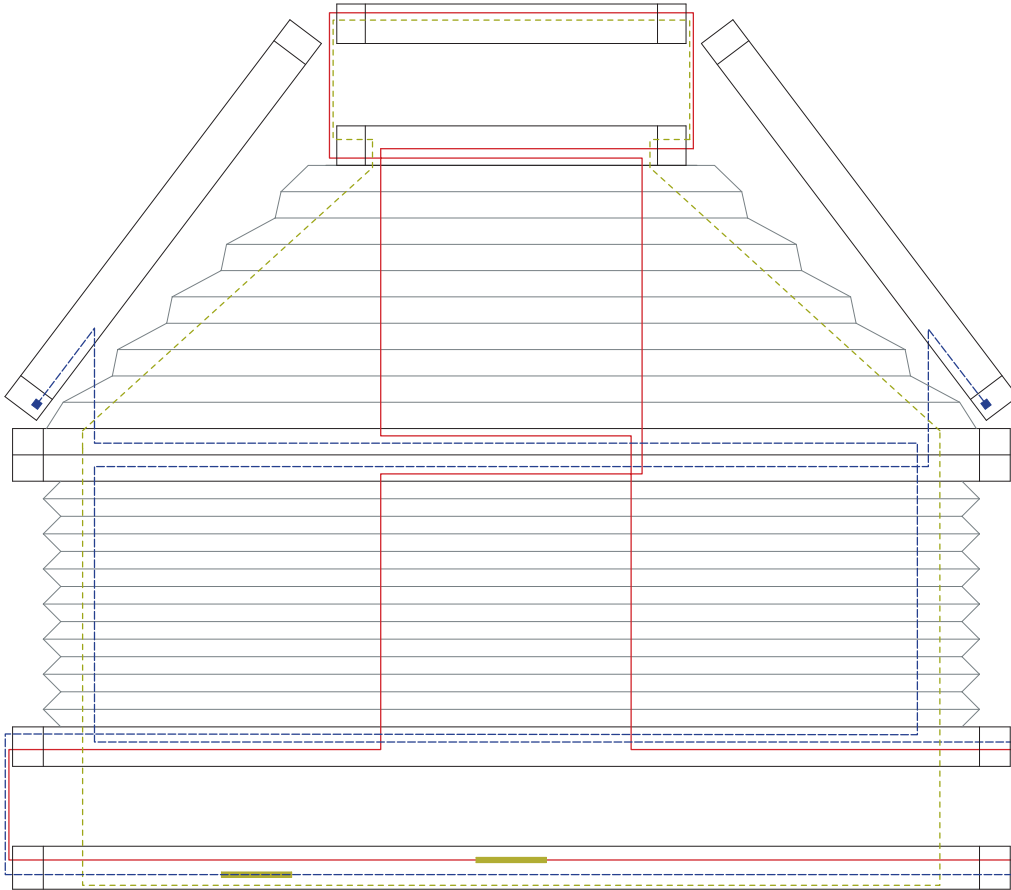

4 Schnurbohrungen/Cord boreholes/Passages de cordon

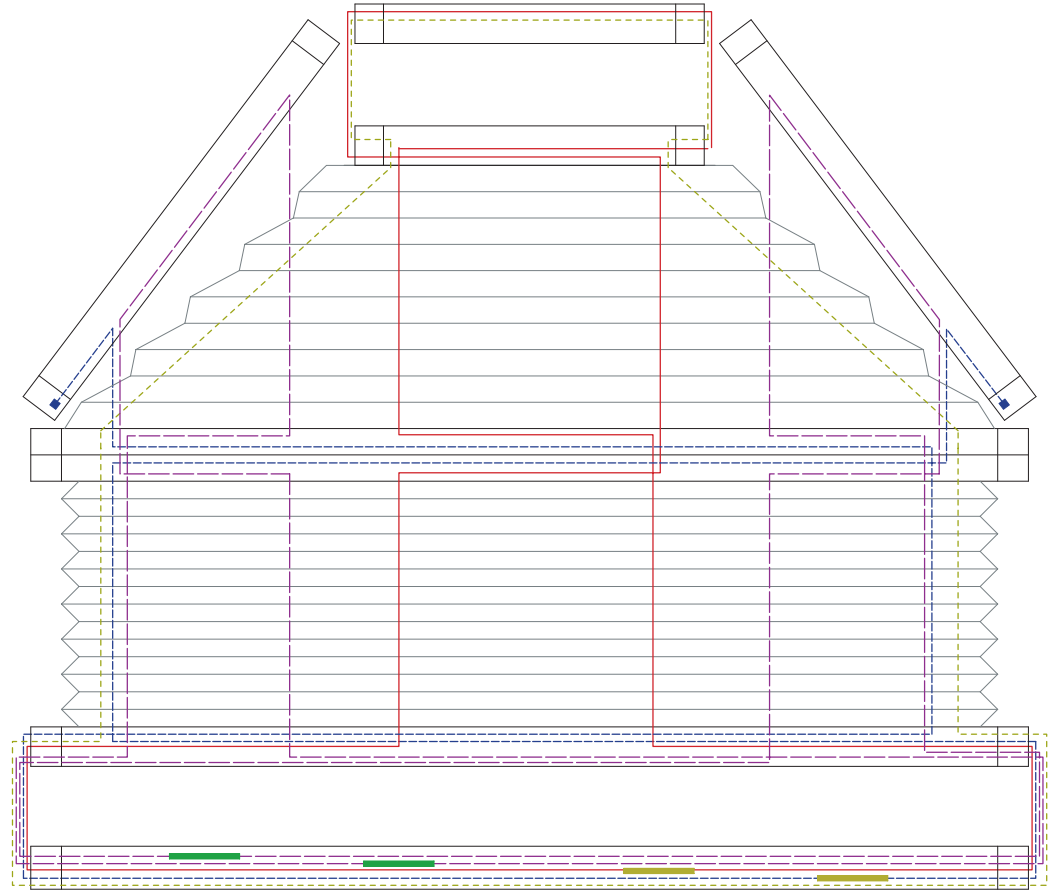

6 Schnurbohrungen/Cord boreholes/Passages de cordon



P 1661-2

- 1. Plisseeschnur/Pleating cord/Cordon à plisser Ø0,8 mm
- - - 2. Plisseeschnur/Pleating cord/Cordon à plisser Ø0,8 mm
- - - 3. Plisseeschnur/Pleating cord/Cordon à plisser Ø0,8 mm
- - - 4. Plisseeschnur/Pleating cord/Cordon à plisser Ø0,8 mm

- - - 5. Plisseeschnur/Pleating cord/Cordon à plisser Ø0,8 mm
- - - Gummiband/Rubber band/Ruban en caoutchouc Ø1,25 mm
- Zugfeder/Tension spring/Ressort de traction Ø0,4 x 44 mm
- Zugfeder/Tension spring/Ressort de traction Ø0,7 x 44 mm

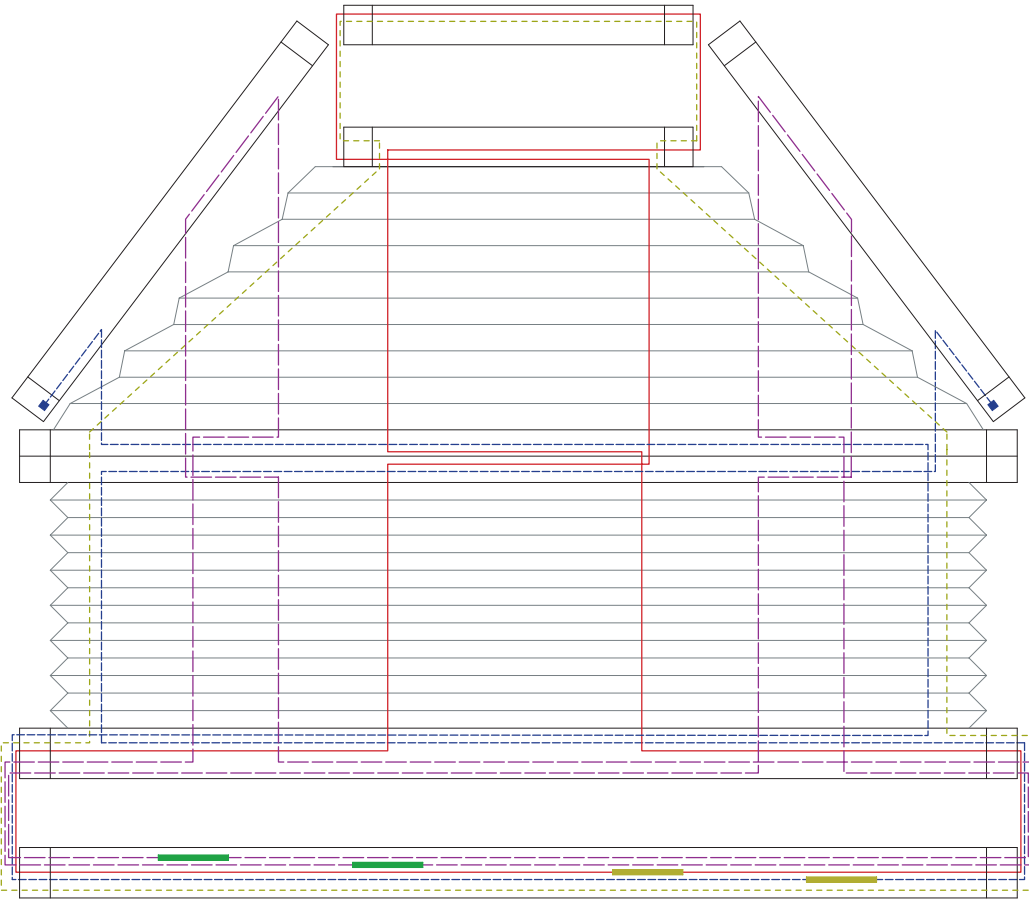

8 Schnurbohrungen/Cord boreholes/Passages de cordon



P 1661-3

- 1. Plisseeschnur/Pleating cord/Cordon à plisser Ø0,8 mm
- - - 2. Plisseeschnur/Pleating cord/Cordon à plisser Ø0,8 mm
- - - 3. Plisseeschnur/Pleating cord/Cordon à plisser Ø0,8 mm
- - - 4. Plisseeschnur/Pleating cord/Cordon à plisser Ø0,8 mm

- - - 5. Plisseeschnur/Pleating cord/Cordon à plisser Ø0,8 mm
- - - Gummiband/Rubber band/Ruban en caoutchouc Ø1,25 mm
- Zugfeder/Tension spring/Ressort de traction Ø0,4 x 44 mm
- Zugfeder/Tension spring/Ressort de traction Ø0,7 x 44 mm

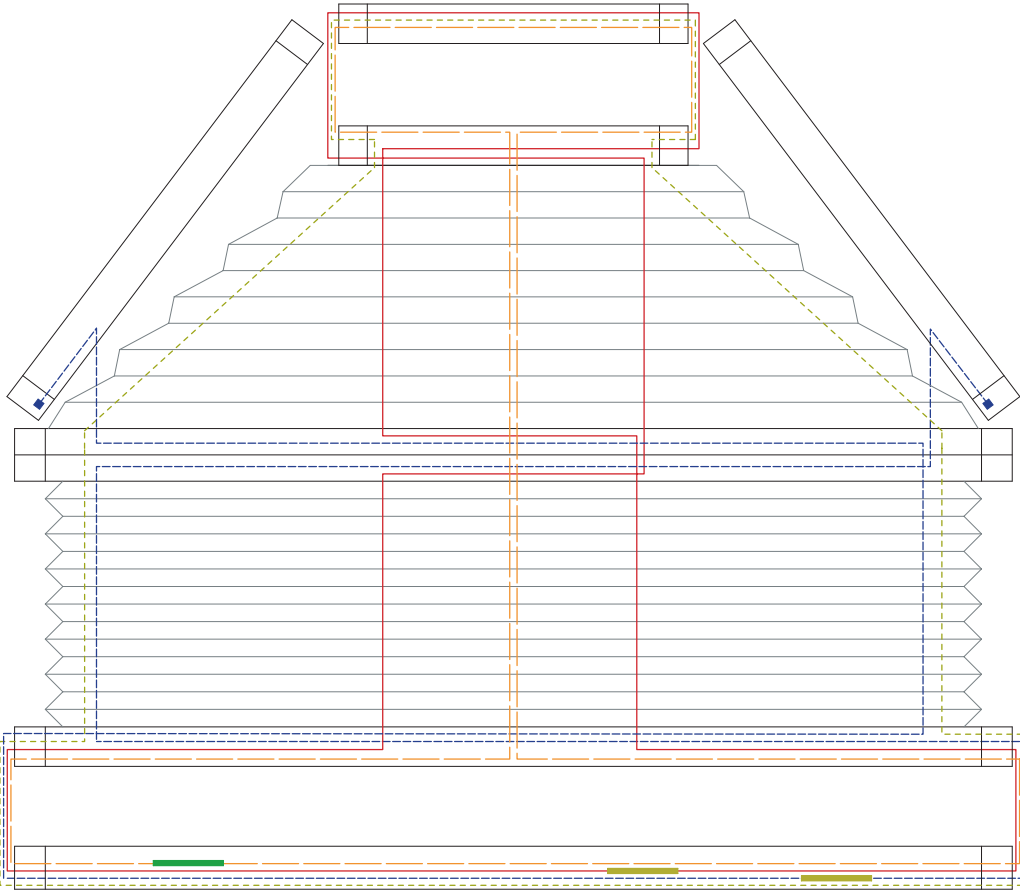

5 Schnurbohrungen/Cord boreholes/Passages de cordon

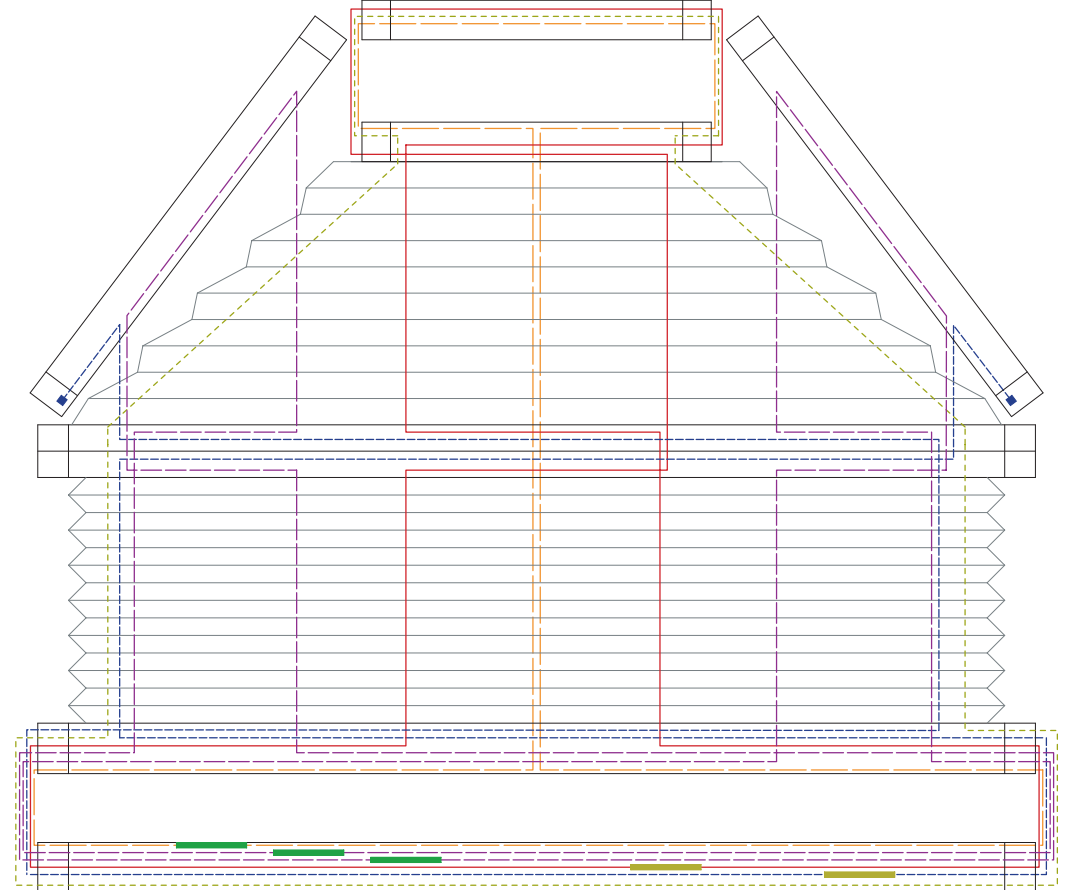

7 Schnurbohrungen/Cord boreholes/Passages de cordon



P 1661-4

- 1. Plisseeschnur/Pleating cord/Cordon à plisser Ø0,8 mm
- - - 2. Plisseeschnur/Pleating cord/Cordon à plisser Ø0,8 mm
- - - 3. Plisseeschnur/Pleating cord/Cordon à plisser Ø0,8 mm
- - - 4. Plisseeschnur/Pleating cord/Cordon à plisser Ø0,8 mm

- - - 5. Plisseeschnur/Pleating cord/Cordon à plisser Ø0,8 mm
- - - Gummiband/Rubber band/Ruban en caoutchouc Ø1,25 mm
- █ Zugfeder/Tension spring/Ressort de traction Ø0,4 x 44 mm
- █ Zugfeder/Tension spring/Ressort de traction Ø0,7 x 44 mm

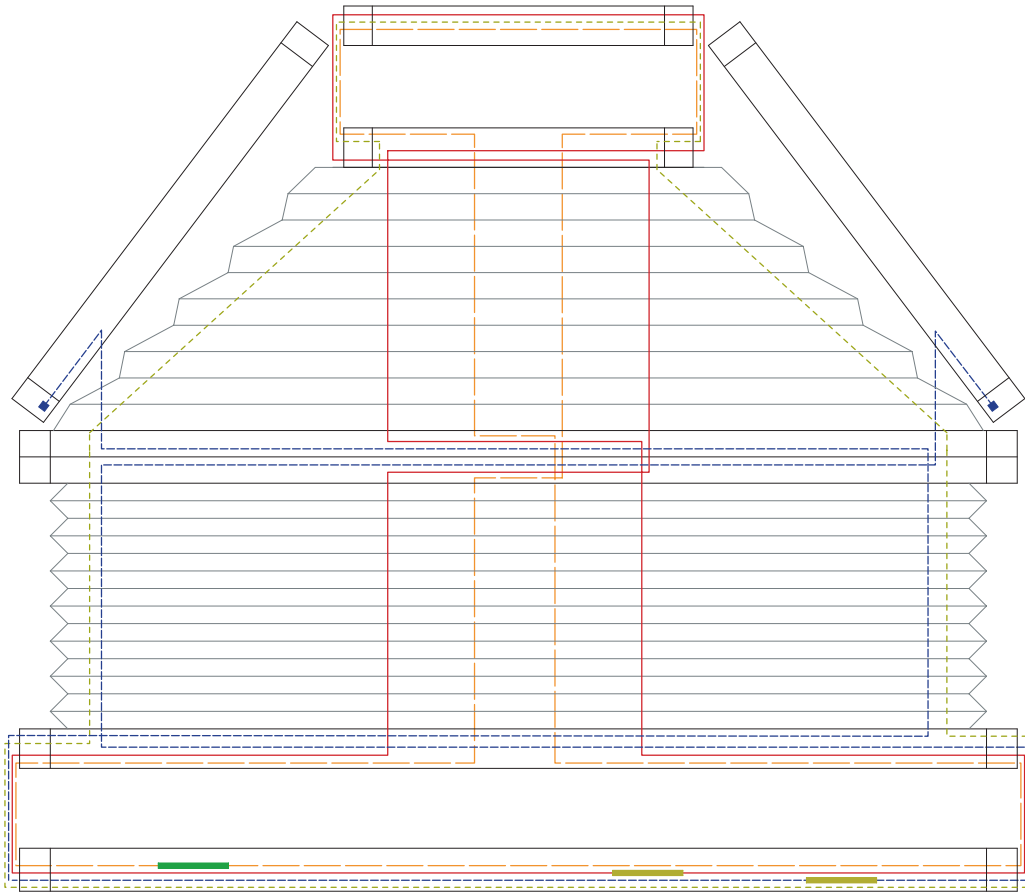

6 Schnurbohrungen/Cord boreholes/Passages de cordon

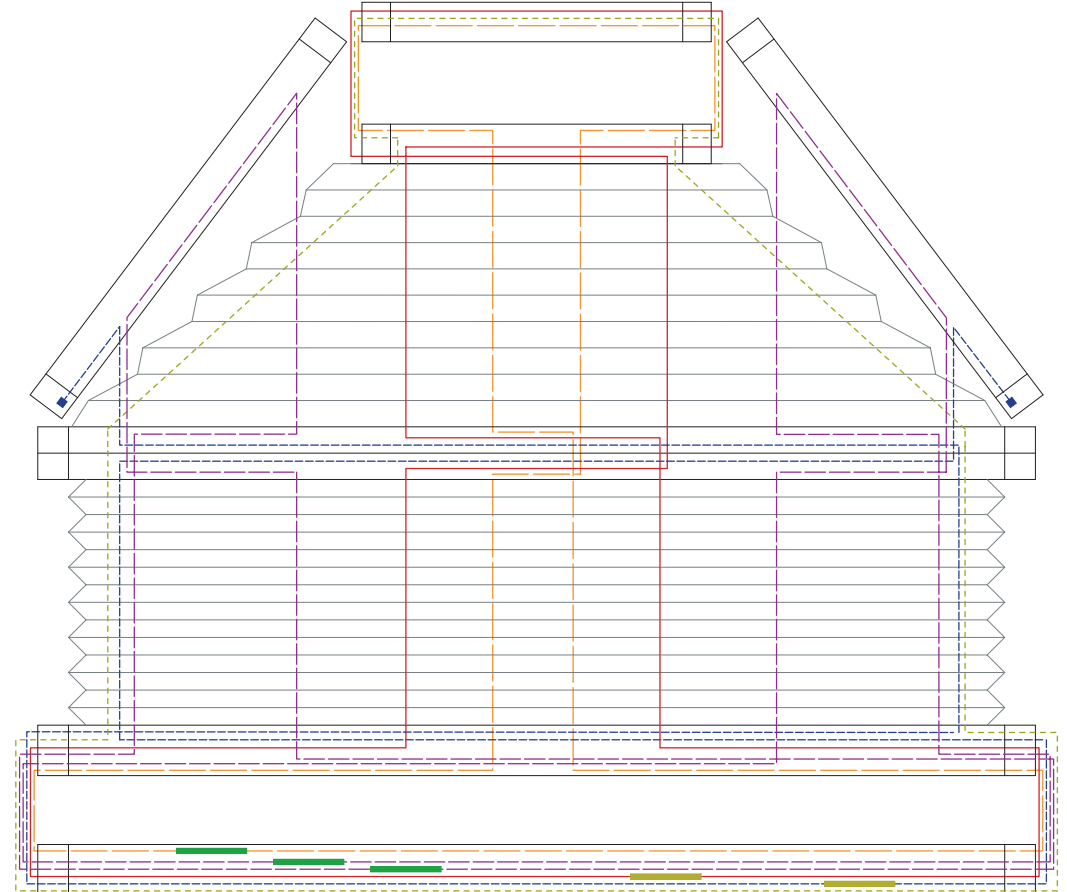

8 Schnurbohrungen/Cord boreholes/Passages de cordon



P 1661-5

- 1. Plisseeschnur/Pleating cord/Cordon à plisser Ø0,8 mm
- - - 2. Plisseeschnur/Pleating cord/Cordon à plisser Ø0,8 mm
- · - 3. Plisseeschnur/Pleating cord/Cordon à plisser Ø0,8 mm
- · - 4. Plisseeschnur/Pleating cord/Cordon à plisser Ø0,8 mm

- · - 5. Plisseeschnur/Pleating cord/Cordon à plisser Ø0,8 mm
- · - Gummiband/Rubber band/Ruban en caoutchouc Ø1,25 mm
- Zugfeder/Tension spring/Ressort de traction Ø0,4 x 44 mm
- Zugfeder/Tension spring/Ressort de traction Ø0,7 x 44 mm

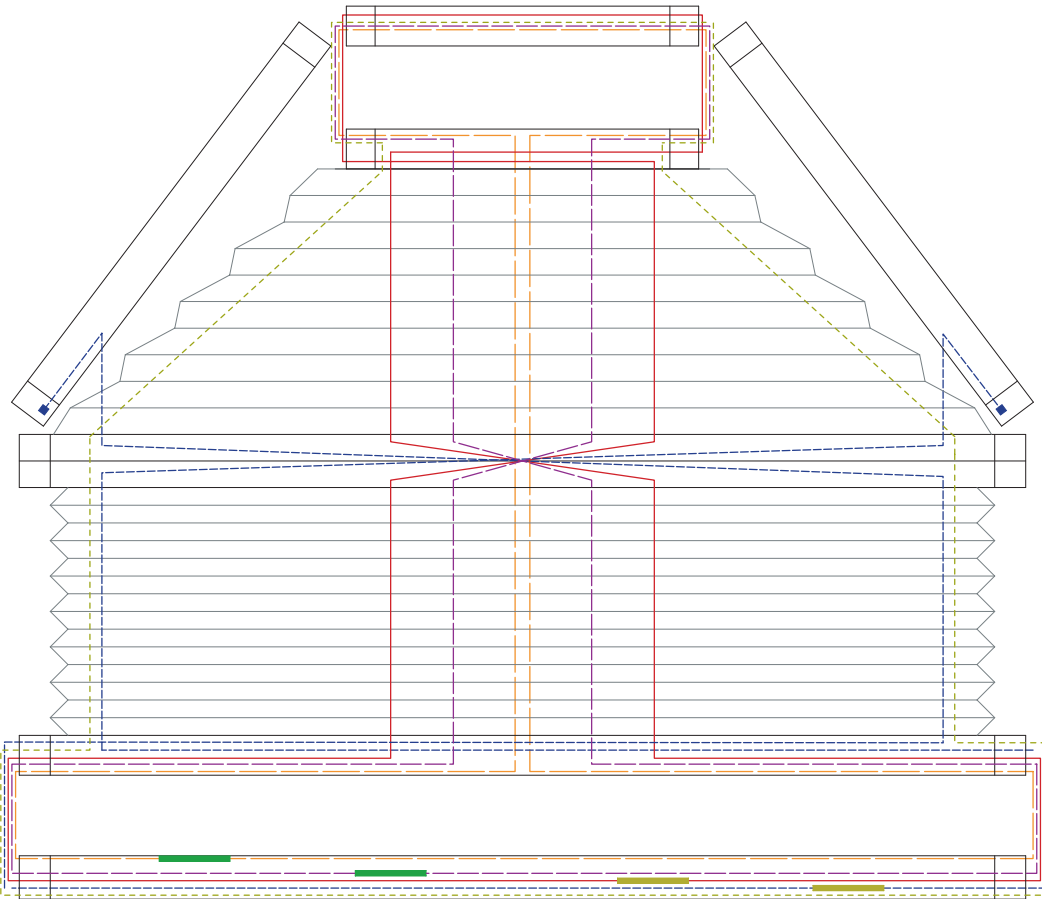

7 Schnurbohrungen/Cord boreholes/Passages de cordon



P 1702

- Plisseeschnur/Pleating cord/Cordon à plisser Ø0,8 mm
- Zugschnur/Pull cord/Cordon de tirage Ø2,2 mm
- - - Wickelschnur/Winding cord/Cordon d'enroulement Ø1,2 mm
- Zugfeder/Tension spring/Ressort de traction Ø0,7 x 44 mm

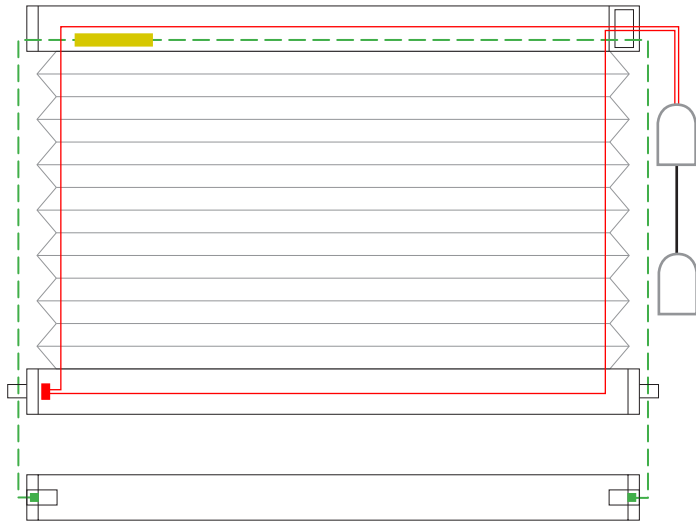

2 Schnurbohrungen/Cord boreholes/Passages de cordon

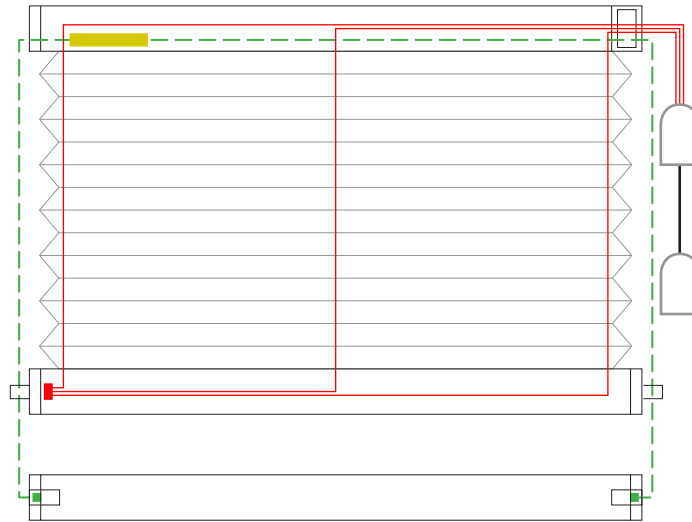

3 Schnurbohrungen/Cord boreholes/Passages de cordon

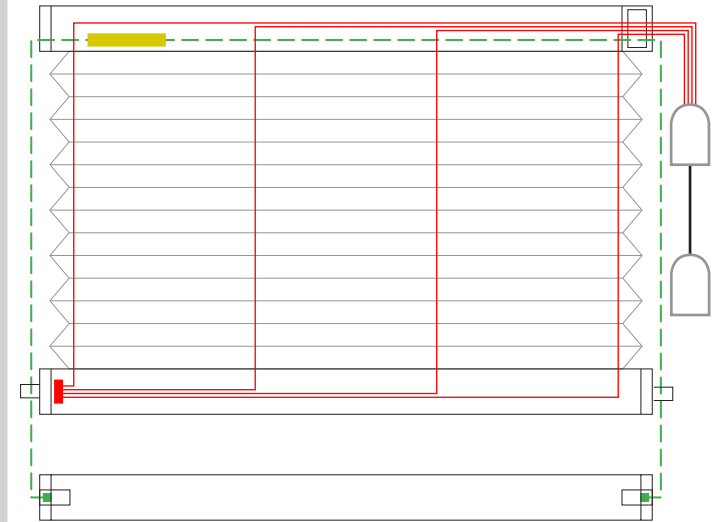

4 Schnurbohrungen/Cord boreholes/Passages de cordon

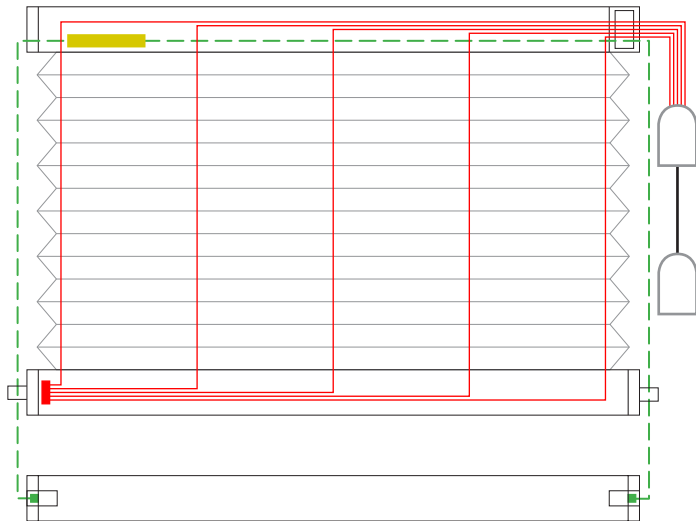

5 Schnurbohrungen/Cord boreholes/Passages de cordon

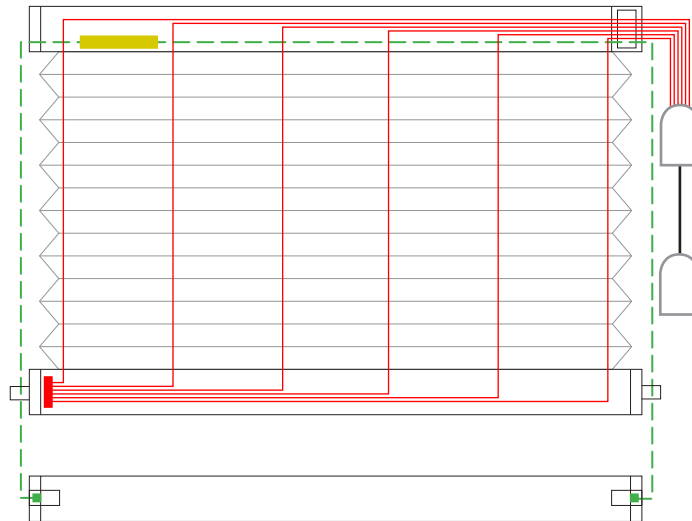

6 Schnurbohrungen/Cord boreholes/Passages de cordon

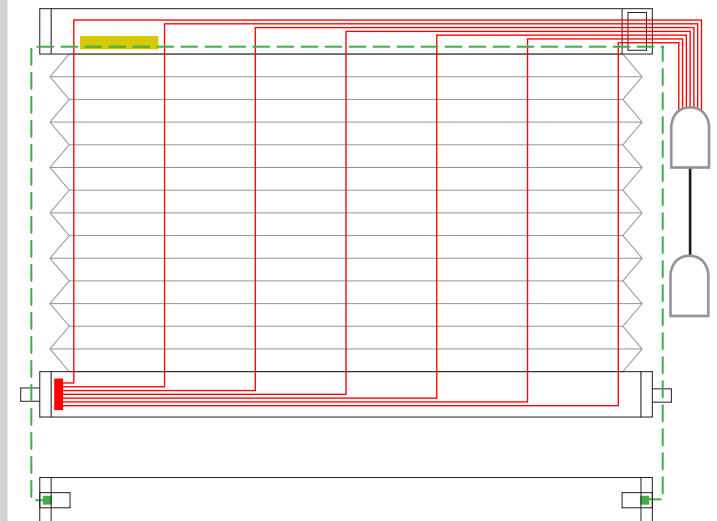

7 Schnurbohrungen/Cord boreholes/Passages de cordon



P 1712

- 1. Plisseeschnur/Pleating cord/Cordon à plisser Ø0,8 mm
- - - 2. Plisseeschnur/Pleating cord/Cordon à plisser Ø0,8 mm
- Zugschnur/Pull cord/Cordon de tirage Ø2,2 mm
- - - Wickelschnur/Winding cord/Cordon d'enroulement Ø1,2 mm

Zugfeder/Tension spring/Ressort de traction Ø0,7 x 44 mm

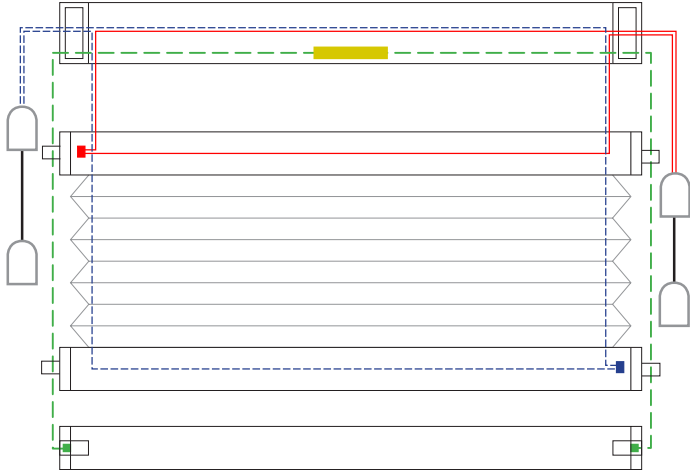

2 Schnurbohrungen/Cord boreholes/Passages de cordon

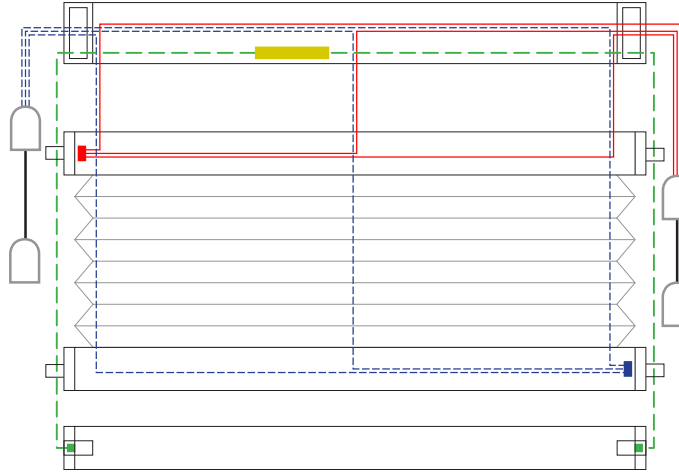

3 Schnurbohrungen/Cord boreholes/Passages de cordon

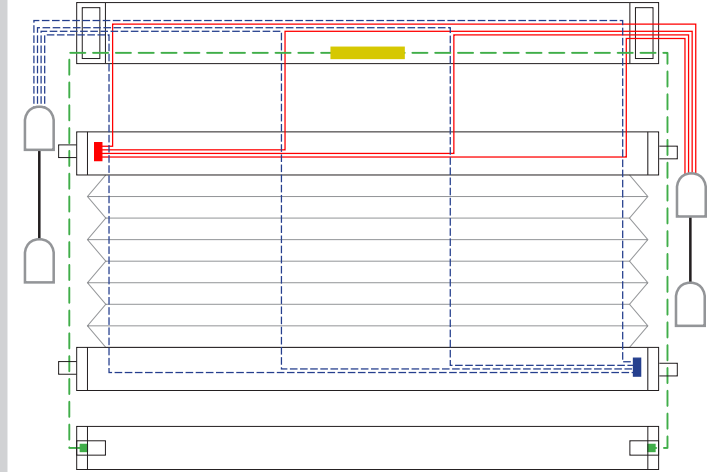

4 Schnurbohrungen/Cord boreholes/Passages de cordon

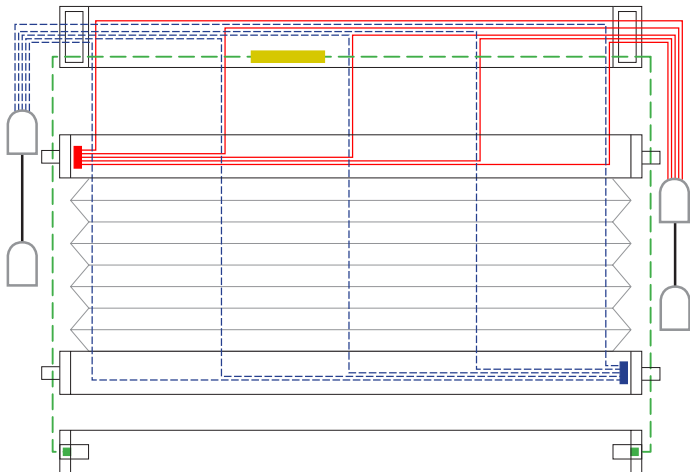

5 Schnurbohrungen/Cord boreholes/Passages de cordon

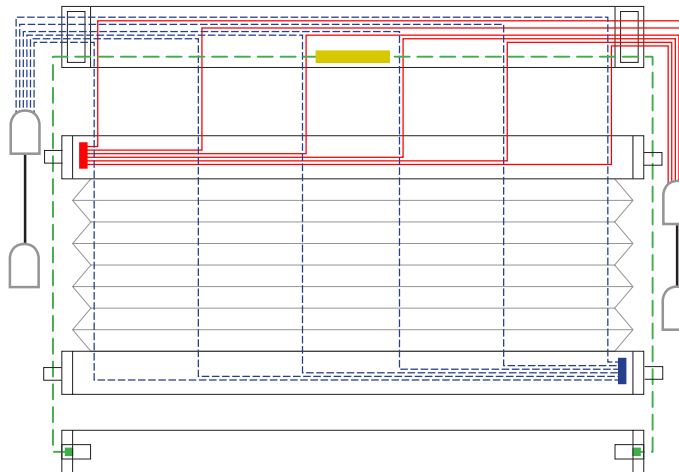

6 Schnurbohrungen/Cord boreholes/Passages de cordon

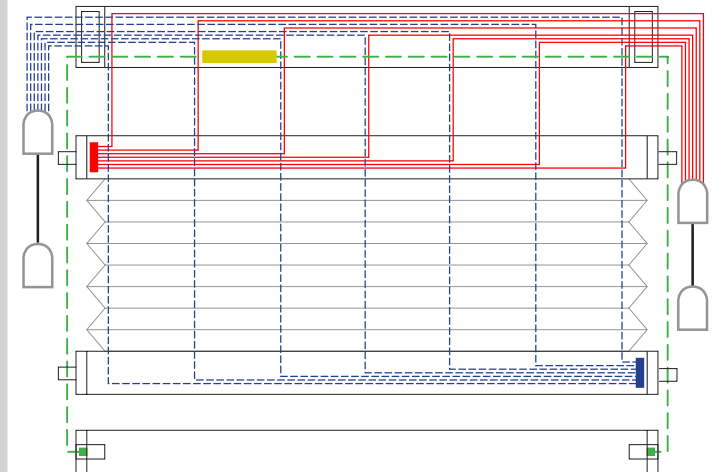

7 Schnurbohrungen/Cord boreholes/Passages de cordon



P 1722

- 1. Plisseeschnur/Pleating cord/Cordon à plisser Ø0,8 mm
- - - 2. Plisseeschnur/Pleating cord/Cordon à plisser Ø0,8 mm
- Zugschnur/Pull cord/Cordon de tirage Ø2,2 mm
- - - Wickelschnur/Winding cord/Cordon d'enroulement Ø1,2 mm

Zugfeder/Tension spring/Ressort de traction Ø0,7 x 44 mm



2 Schnurbohrungen/Cord boreholes/Passages de cordon

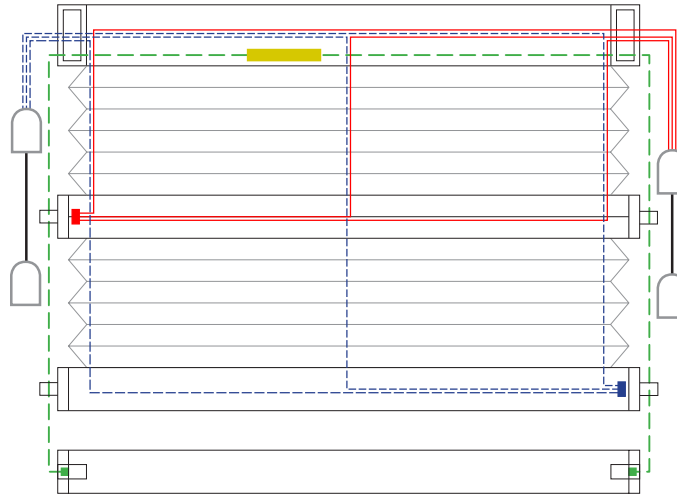

3 Schnurbohrungen/Cord boreholes/Passages de cordon

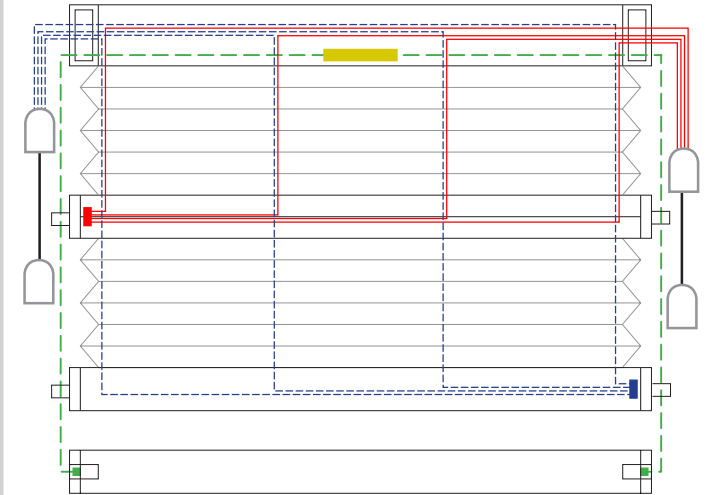

4 Schnurbohrungen/Cord boreholes/Passages de cordon

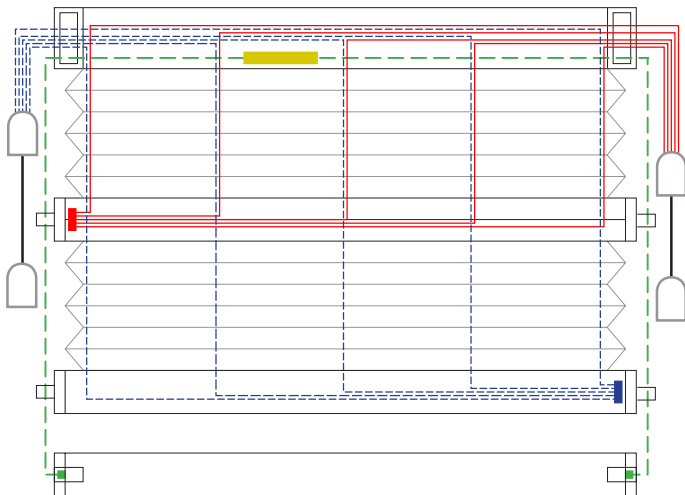

5 Schnurbohrungen/Cord boreholes/Passages de cordon

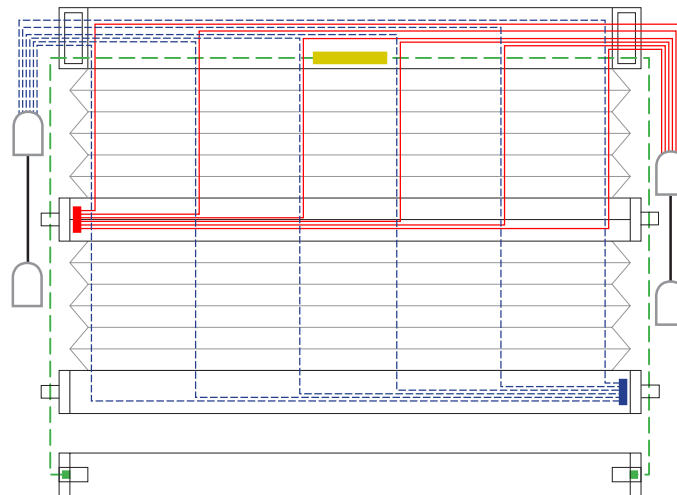



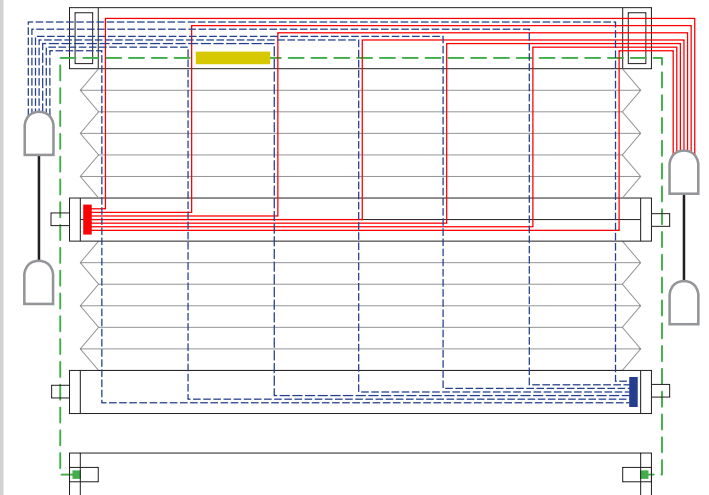

6 Schnurbohrungen/Cord boreholes/Passages de cordon



7 Schnurbohrungen/Cord boreholes/Passages de cordon



P 1730 1S

-  Plisseeschnur/Pleating cord/Cordon à plisser Ø0,8 mm
-  Zugschnur/Pull cord/Cordon de tirage Ø2,2 mm
-  Spannschnur/Tension cord/Cordon de tension Ø0,8 mm
-  Zugfeder/Tension spring/Ressort de traction Ø0,7 x 44 mm

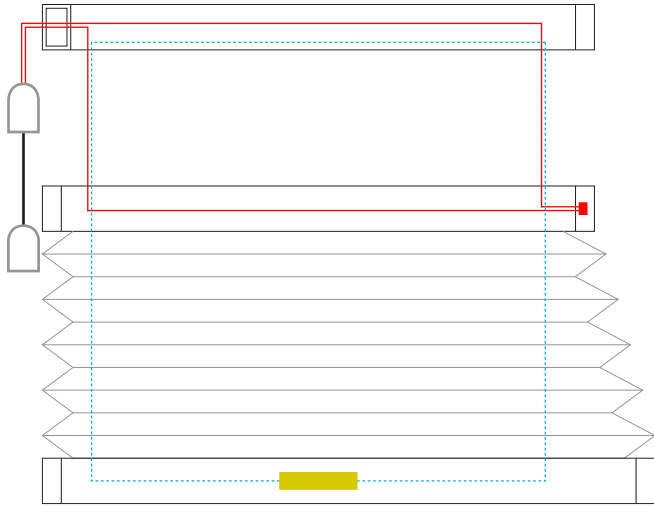

2 Schnurbohrungen/Cord boreholes/Passages de cordon

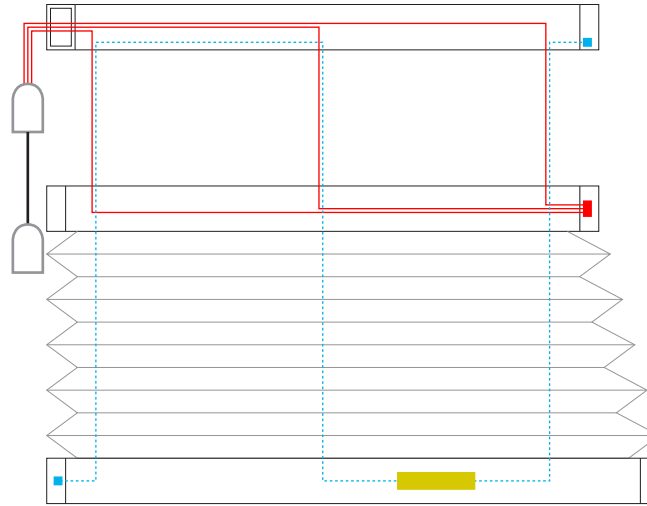

3 Schnurbohrungen/Cord boreholes/Passages de cordon

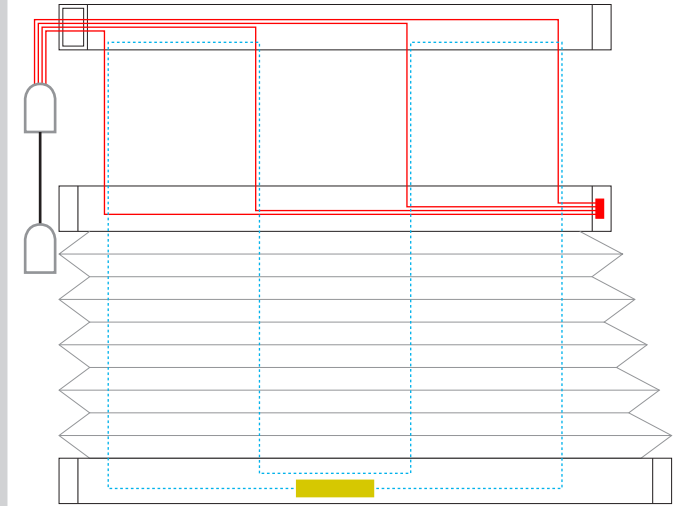

4 Schnurbohrungen/Cord boreholes/Passages de cordon

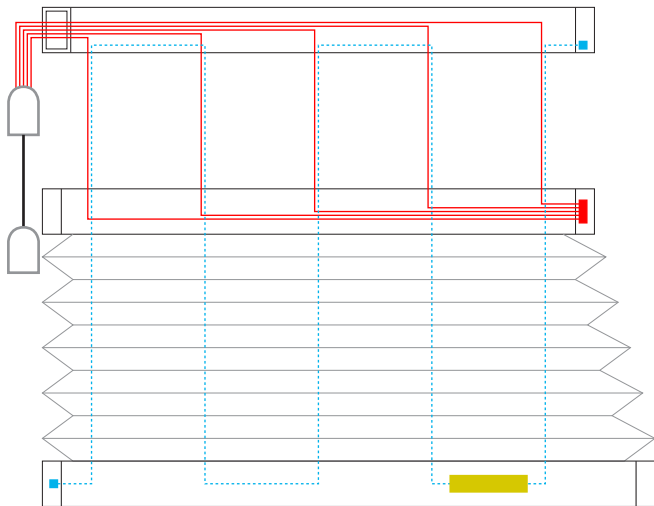

5 Schnurbohrungen/Cord boreholes/Passages de cordon

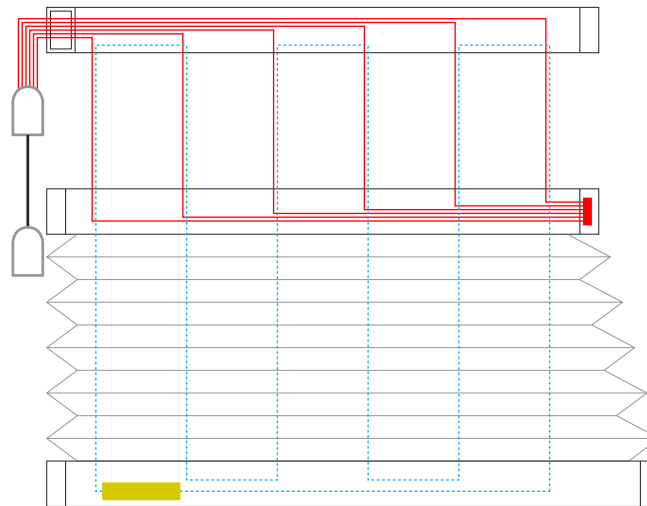

6 Schnurbohrungen/Cord boreholes/Passages de cordon

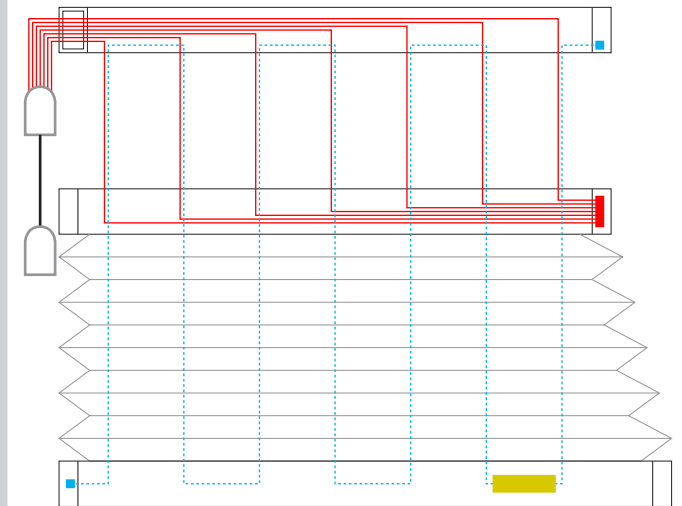

7 Schnurbohrungen/Cord boreholes/Passages de cordon



P 1730 2S

- Plisseeschnur/Pleating cord/Cordon à plisser Ø0,8 mm
- Zugschnur/Pull cord/Cordon de tirage Ø2,2 mm
- Spannschnur/Tension cord/Cordon de tension Ø0,8 mm
- Zugfeder/Tension spring/Ressort de traction Ø0,7 x 44 mm

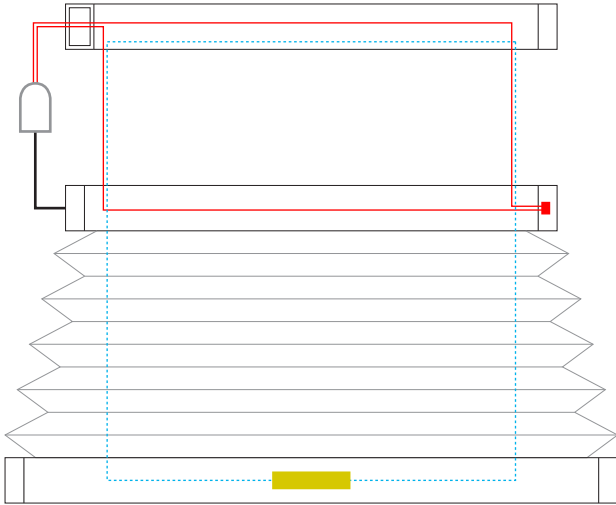

2 Schnurbohrungen/Cord boreholes/Passages de cordon

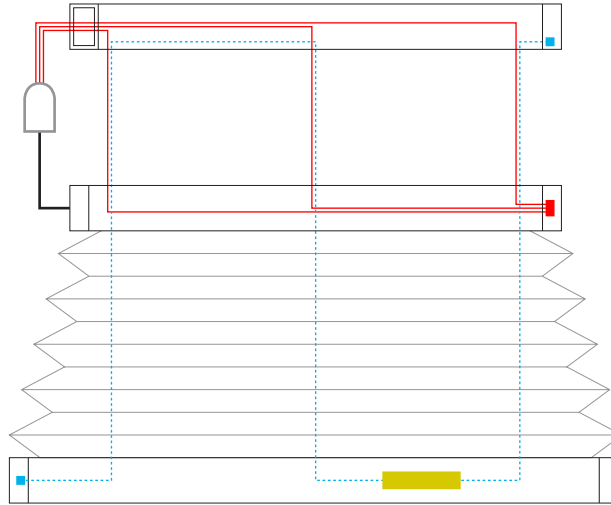

3 Schnurbohrungen/Cord boreholes/Passages de cordon

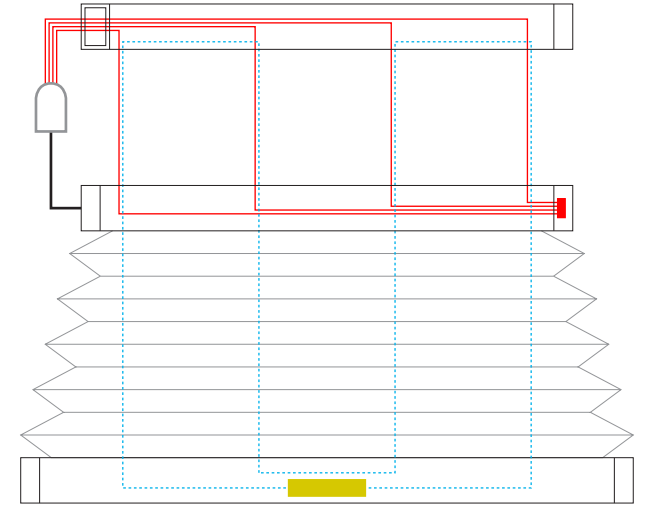

4 Schnurbohrungen/Cord boreholes/Passages de cordon

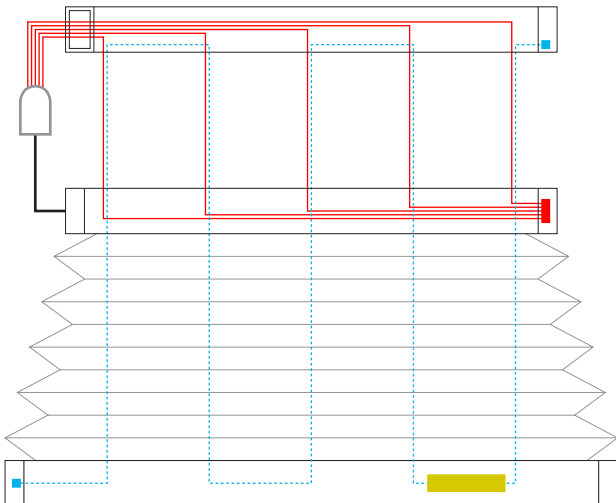

5 Schnurbohrungen/Cord boreholes/Passages de cordon

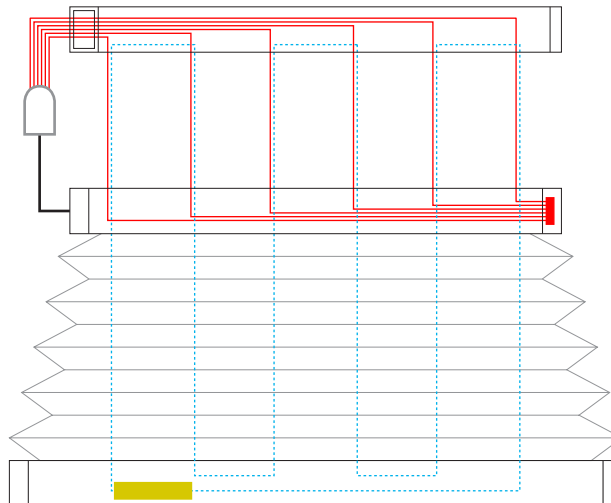

6 Schnurbohrungen/Cord boreholes/Passages de cordon

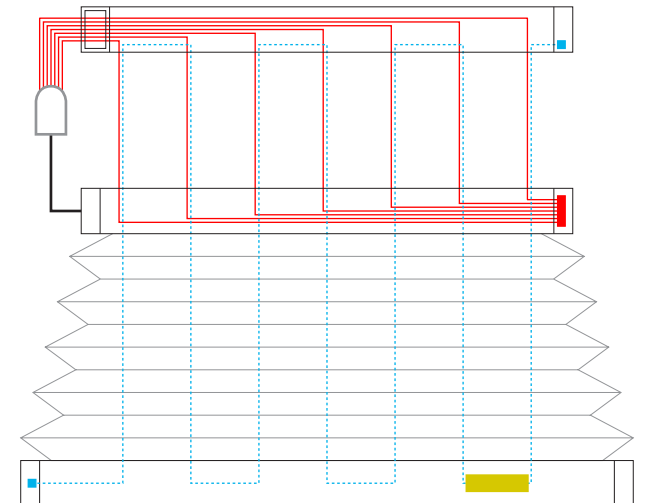

7 Schnurbohrungen/Cord boreholes/Passages de cordon



P 1750

- 1. Plisseeschnur/Pleating cord/Cordon à plisser Ø0,8 mm
- - - 2. Plisseeschnur/Pleating cord/Cordon à plisser Ø0,8 mm
- Zugschnur/Pull cord/Cordon de tirage Ø2,2 mm

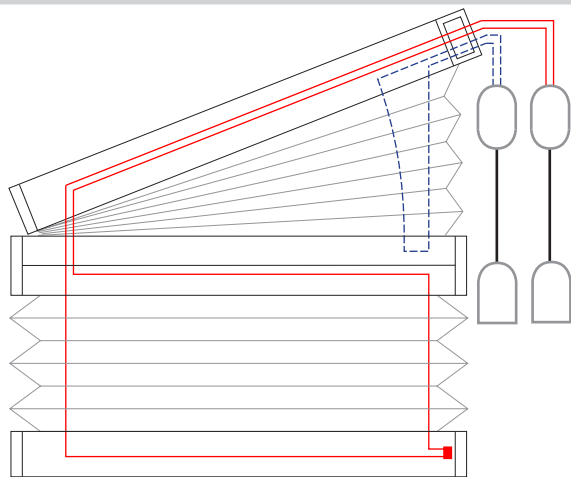

2 Schnurbohrungen/Cord boreholes/Passages de cordon

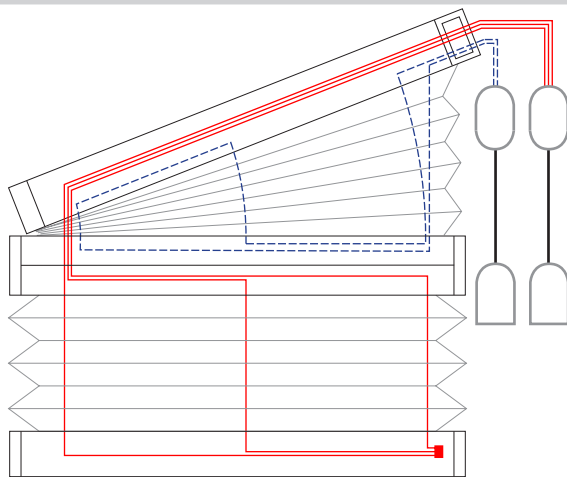

3 Schnurbohrungen/Cord boreholes/Passages de cordon

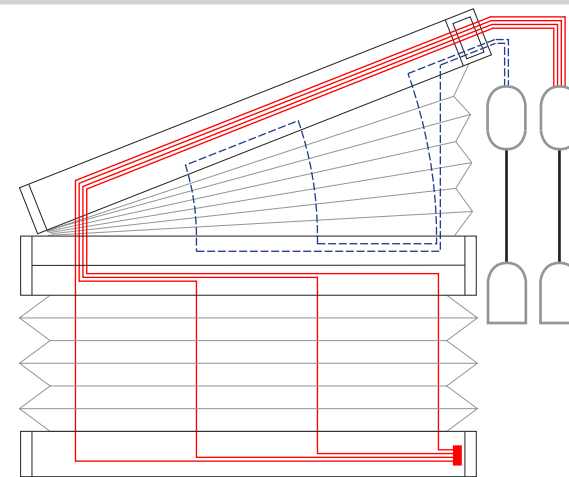

4 Schnurbohrungen/Cord boreholes/Passages de cordon

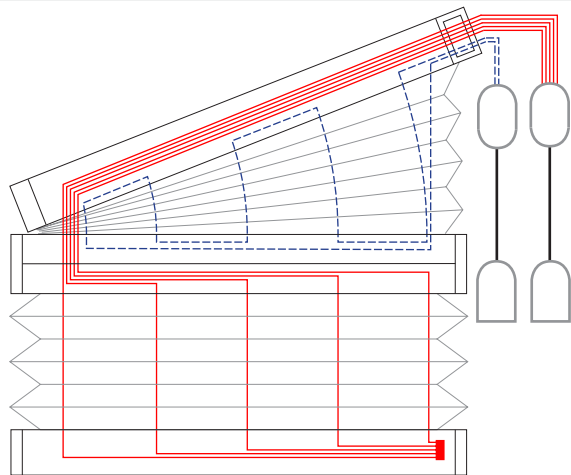

5 Schnurbohrungen/Cord boreholes/Passages de cordon

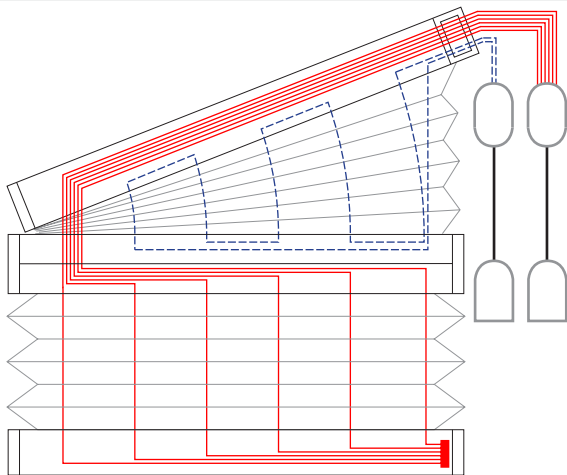

6 Schnurbohrungen/Cord boreholes/Passages de cordon



P 1752

- 1. Plisseeschnur/Pleating cord/Cordon à plisser Ø0,8 mm
- - - 2. Plisseeschnur/Pleating cord/Cordon à plisser Ø0,8 mm
- Zugschnur/Pull cord/Cordon de tirage Ø2,2 mm
- Zugfeder/Tension spring/Ressort de traction Ø0,4 x 44 mm

Schnurspanner/Cord stretcher/Tendeur de cordon

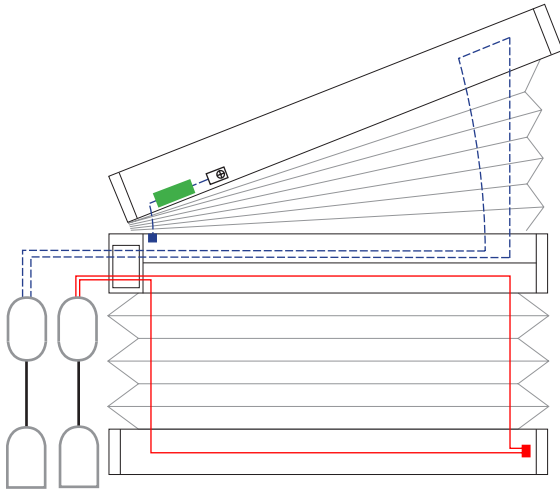

2 Schnurbohrungen/Cord boreholes/Passages de cordon

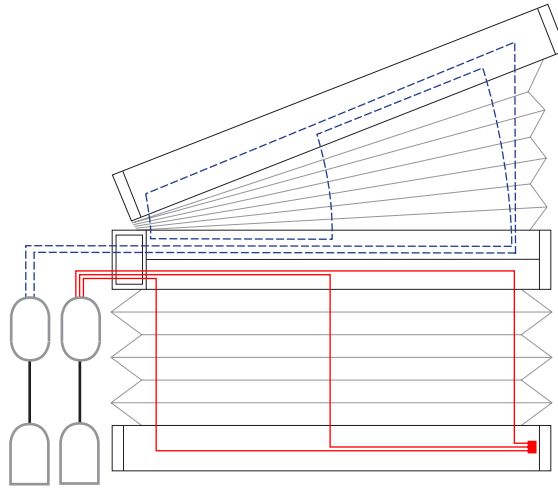

3 Schnurbohrungen/Cord boreholes/Passages de cordon

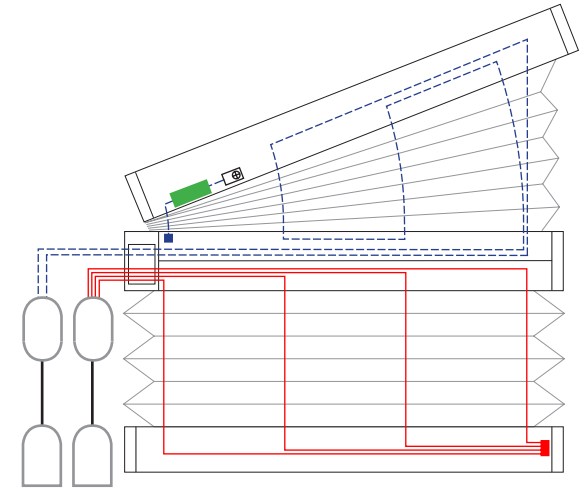

4 Schnurbohrungen/Cord boreholes/Passages de cordon

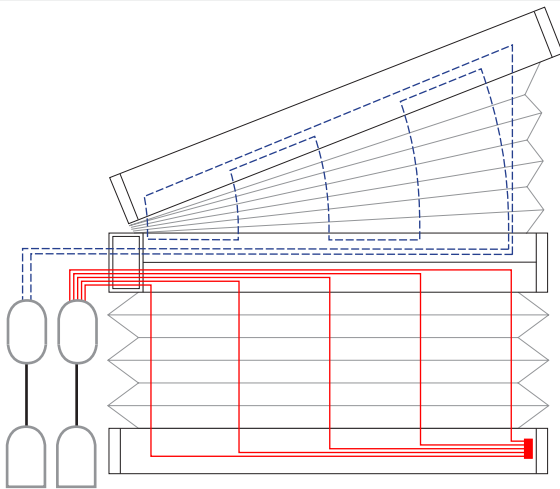

5 Schnurbohrungen/Cord boreholes/Passages de cordon

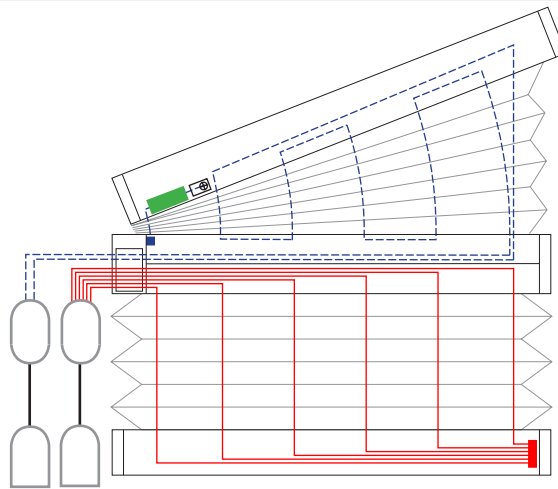

6 Schnurbohrungen/Cord boreholes/Passages de cordon



P 1500

- Wickelschnur/Winding cord/Cordon d'enroulement Ø1,2 mm
- SOMFY CTS 25 Schnurwickler/Cord winder/Dévidoir de cordon
- Schnurspanner/Cord stretcher/Tendeur de cordon



Federantrieb/Spring drive/Entraînement par ressort



2 Schnurbohrungen/Cord boreholes/Passages de cordon

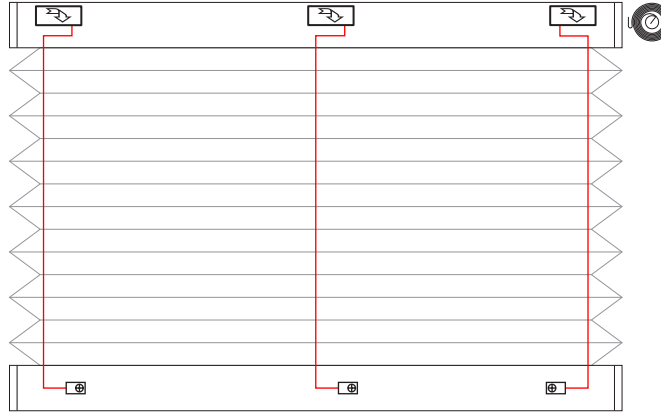

3 Schnurbohrungen/Cord boreholes/Passages de cordon

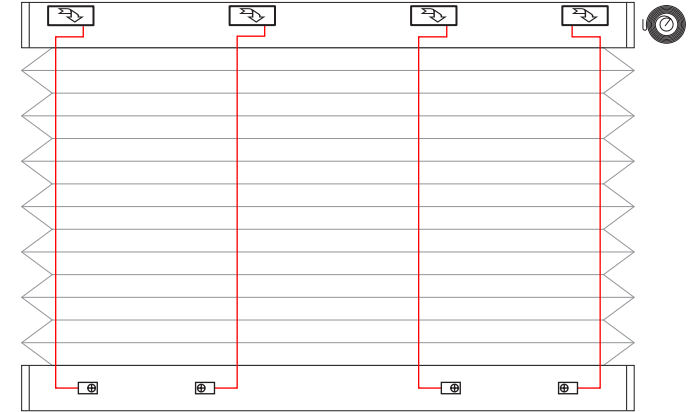

4 Schnurbohrungen/Cord boreholes/Passages de cordon



5 Schnurbohrungen/Cord boreholes/Passages de cordon

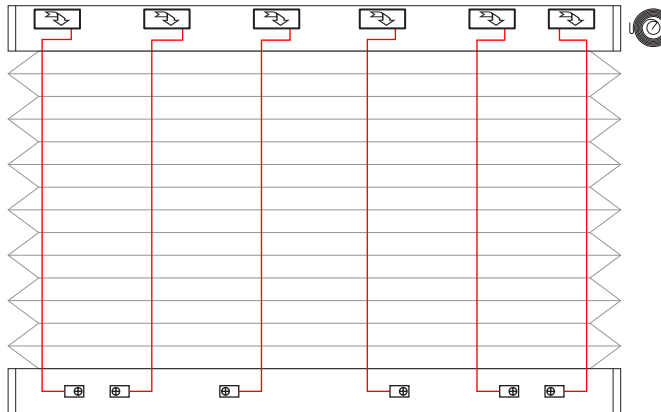

6 Schnurbohrungen/Cord boreholes/Passages de cordon



P 1505

— Wickelschnur/Winding cord/Cordon d'enroulement Ø1,2 mm

□ SOMFY CTS 25 Schnurwickler/Cord winder/Dévidoir de cordon

- - - Wickelschnur/Winding cord/Cordon d'enroulement Ø1,2 mm

■ Zugfeder/Tension spring/Ressort de traction Ø0,7 x 44 mm

☐ Schnurspanner/Cord stretcher/Tendeur de cordon



Federantrieb/Spring drive/Entraînement par ressort

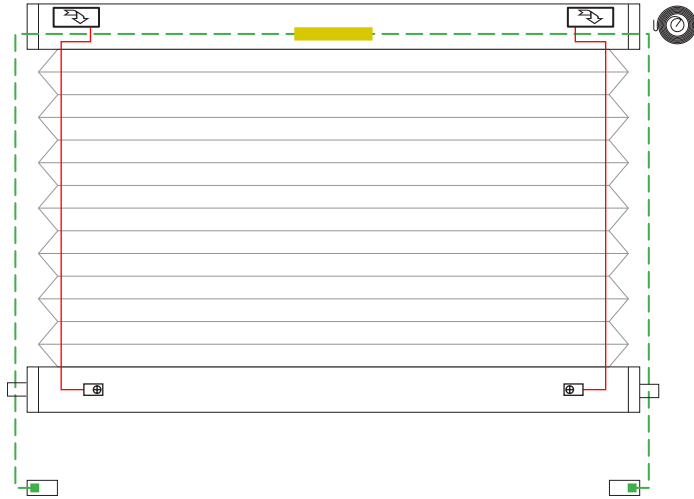

2 Schnurbohrungen/Cord boreholes/Passages de cordon



3 Schnurbohrungen/Cord boreholes/Passages de cordon



4 Schnurbohrungen/Cord boreholes/Passages de cordon

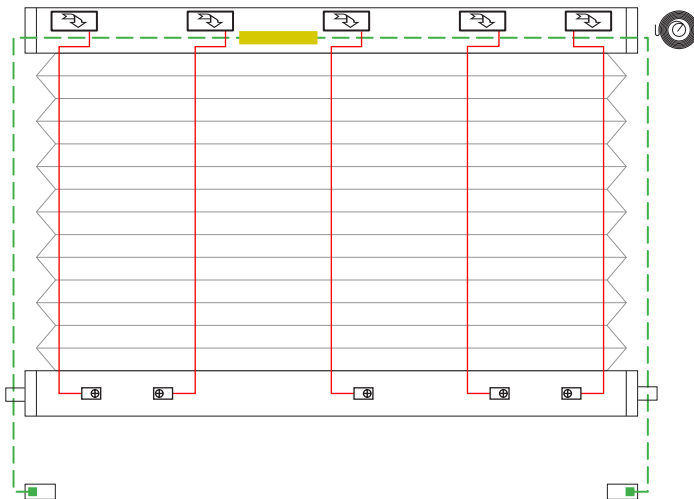

5 Schnurbohrungen/Cord boreholes/Passages de cordon



6 Schnurbohrungen/Cord boreholes/Passages de cordon



P 1802

- Wickelschnur/Winding cord/Cordon d'enroulement Ø1,2 mm
- SOMFY CTS 25 Schnurwickler/Cord winder/Dévidoir de cordon
- - - Wickelschnur/Winding cord/Cordon d'enroulement Ø1,2 mm
- Zugfeder/Tension spring/Ressort de traction Ø0,7 x 44 mm

Schnurspanner/Cord stretcher/Tendeur de cordon

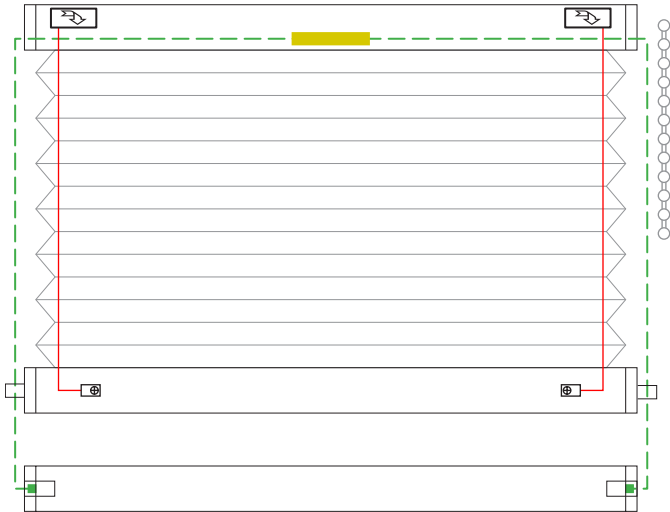

2 Schnurbohrungen/Cord boreholes/Passages de cordon



3 Schnurbohrungen/Cord boreholes/Passages de cordon

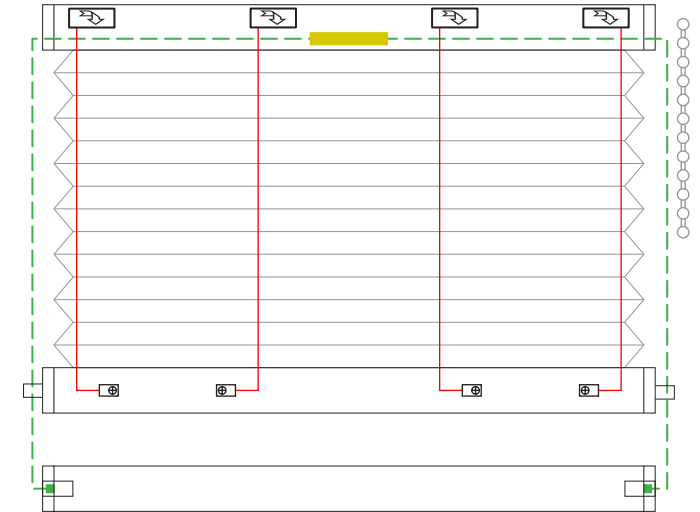

4 Schnurbohrungen/Cord boreholes/Passages de cordon



5 Schnurbohrungen/Cord boreholes/Passages de cordon

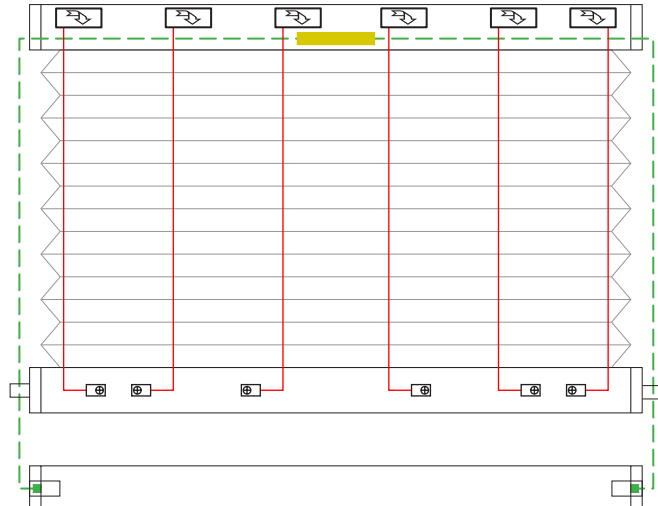

6 Schnurbohrungen/Cord boreholes/Passages de cordon



P 1810

- 1. Wickelschnur/Winding cord/Cordon d'enroulement Ø1,2 mm
- - - 2. Wickelschnur/Winding cord/Cordon d'enroulement Ø1,2 mm
- SOMFY CTS 25 Schnurwickler/Cord winder/Dévidoir de cordon
- Schnurspanner/Cord stretcher/Tendeur de cordon

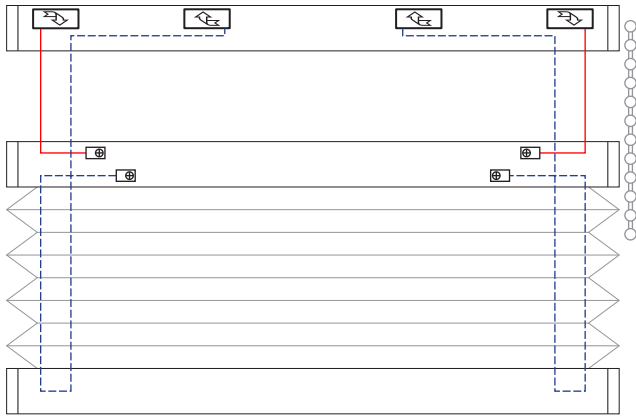

2 Schnurbohrungen/Cord boreholes/Passages de cordon

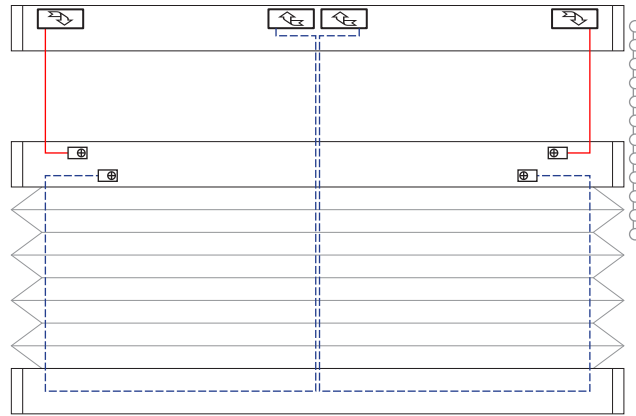

3 Schnurbohrungen/Cord boreholes/Passages de cordon

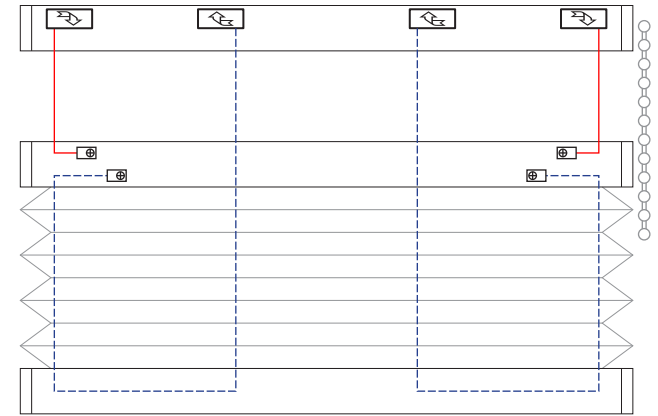

4 Schnurbohrungen/Cord boreholes/Passages de cordon

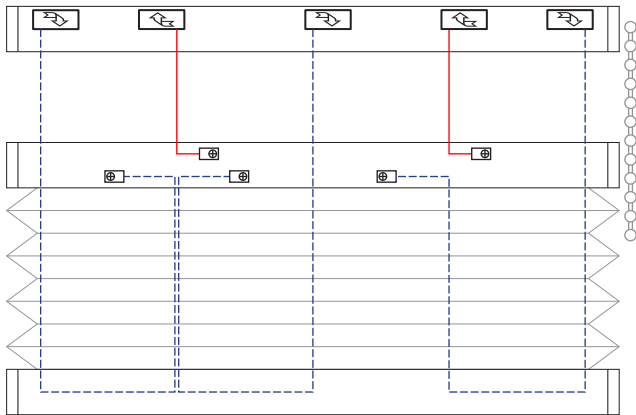

5 Schnurbohrungen/Cord boreholes/Passages de cordon

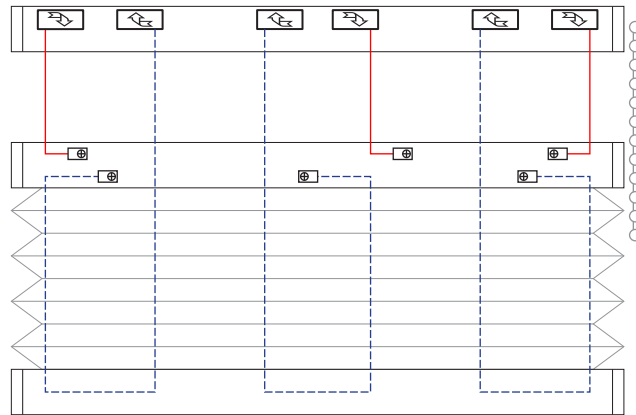

6 Schnurbohrungen/Cord boreholes/Passages de cordon

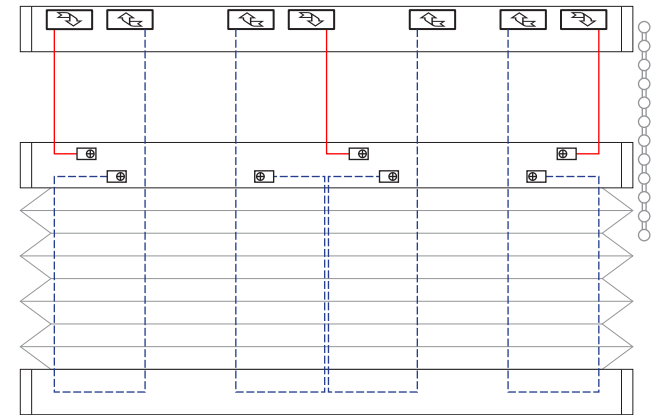

7 Schnurbohrungen/Cord boreholes/Passages de cordon



P 1812

- 1. Wickelschnur/Winding cord/Cordon d'enroulement Ø1,2 mm
- - - 2. Wickelschnur/Winding cord/Cordon d'enroulement Ø1,2 mm
- SOMFY CTS 25 Schnurwickler/Cord winder/Dévidoir de cordon
- - - Wickelschnur/Winding cord/Cordon d'enroulement Ø1,2 mm

Schnurspanner/Cord stretcher/Tendeur de cordon

Zugfeder/Tension spring/Ressort de traction Ø0,7 x 44 mm



2 Schnurbohrungen/Cord boreholes/Passages de cordon



3 Schnurbohrungen/Cord boreholes/Passages de cordon



4 Schnurbohrungen/Cord boreholes/Passages de cordon

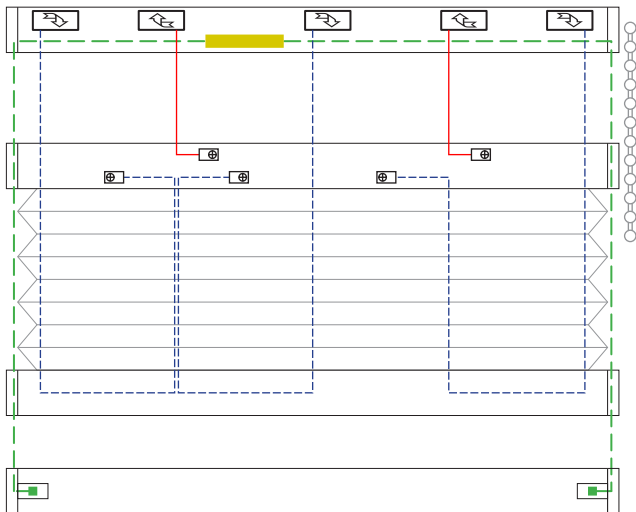

5 Schnurbohrungen/Cord boreholes/Passages de cordon

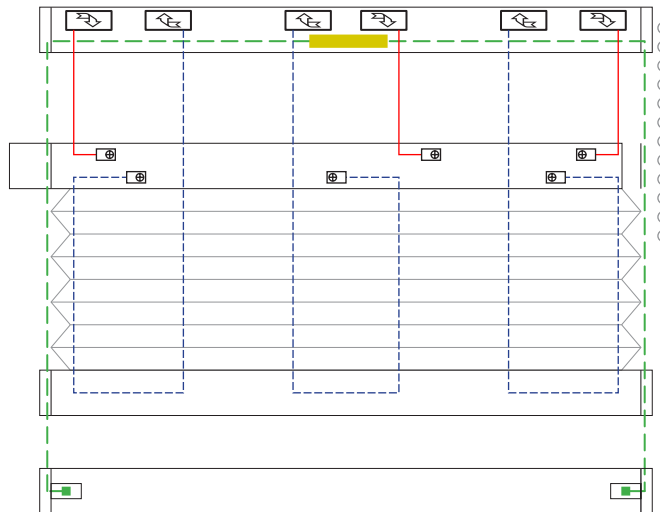

6 Schnurbohrungen/Cord boreholes/Passages de cordon

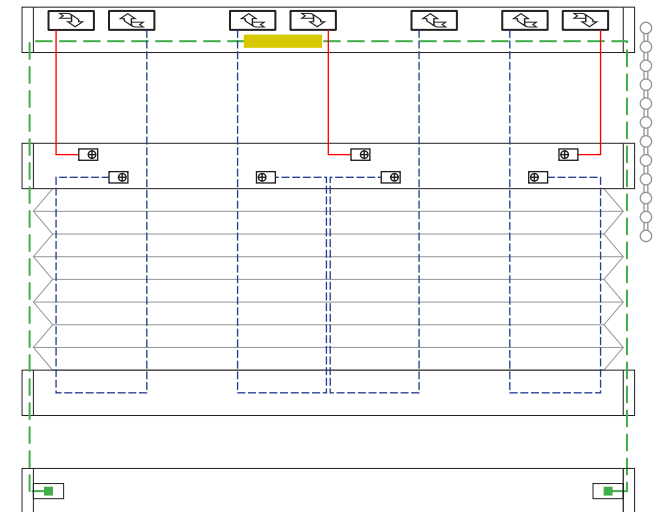

7 Schnurbohrungen/Cord boreholes/Passages de cordon



P 1815

- 1. Wickelschnur/Winding cord/Cordon d'enroulement Ø1,2 mm
- - - 2. Wickelschnur/Winding cord/Cordon d'enroulement Ø1,2 mm
- SOMFY CTS 25 Schnurwickler/Cord winder/Dévidoir de cordon
- - - Wickelschnur/Winding cord/Cordon d'enroulement Ø1,2 mm

Schnurspanner/Cord stretcher/Tendeur de cordon

Zugfeder/Tension spring/Ressort de traction Ø0,7 x 44 mm

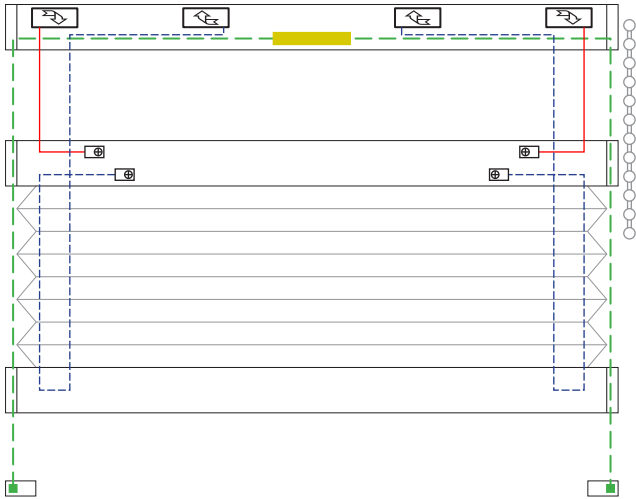

2 Schnurbohrungen/Cord boreholes/Passages de cordon



3 Schnurbohrungen/Cord boreholes/Passages de cordon



4 Schnurbohrungen/Cord boreholes/Passages de cordon

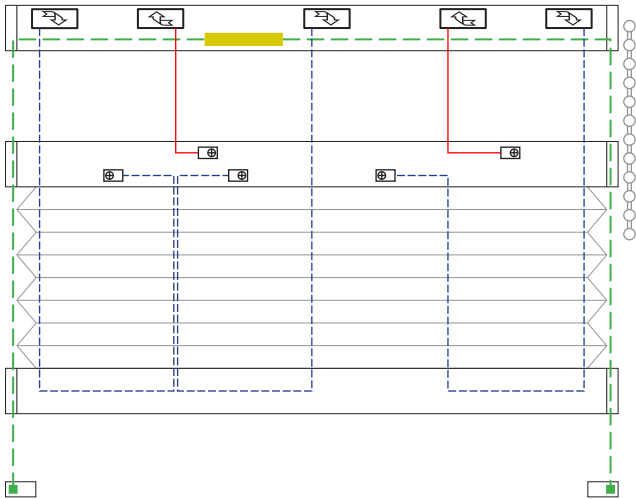

5 Schnurbohrungen/Cord boreholes/Passages de cordon

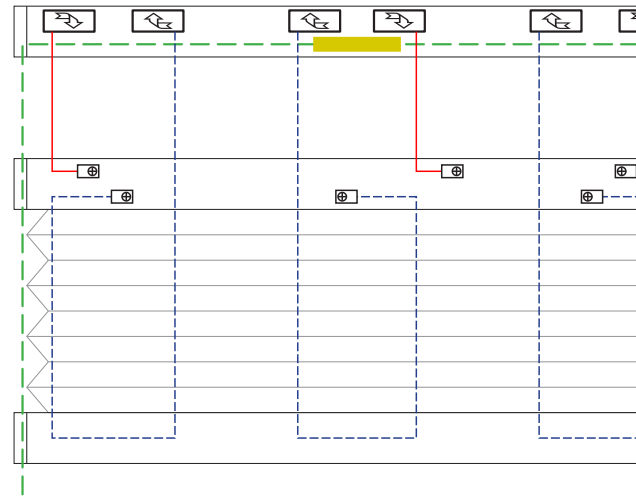

6 Schnurbohrungen/Cord boreholes/Passages de cordon

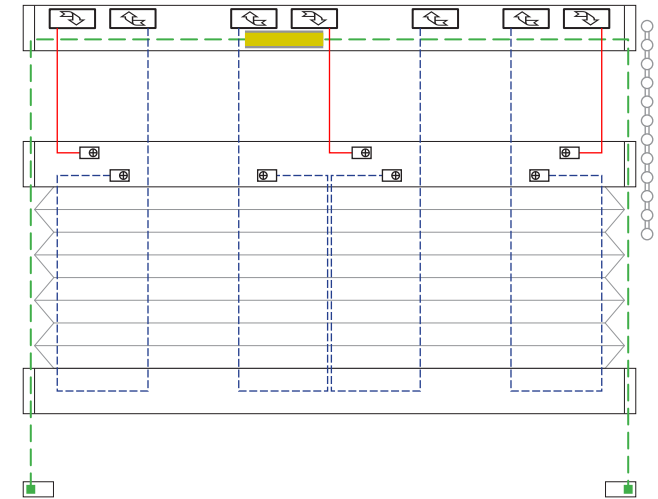

7 Schnurbohrungen/Cord boreholes/Passages de cordon



P 1820

- 1. Wickelschnur/Winding cord/Cordon d'enroulement Ø1,2 mm
- - - 2. Wickelschnur/Winding cord/Cordon d'enroulement Ø1,2 mm
- SOMFY CTS 25 Schnurwickler/Cord winder/Dévidoir de cordon

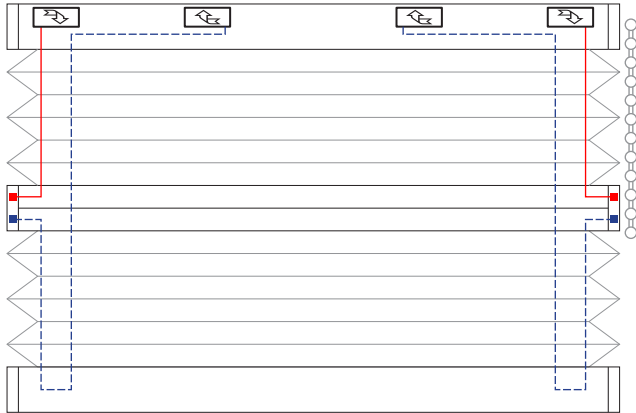

2 Schnurbohrungen/Cord boreholes/Passages de cordon

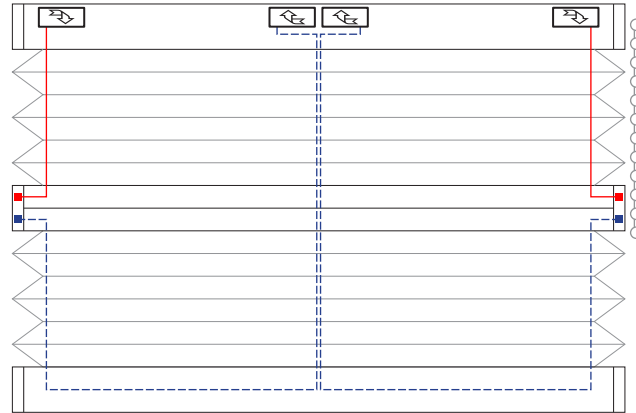

3 Schnurbohrungen/Cord boreholes/Passages de cordon

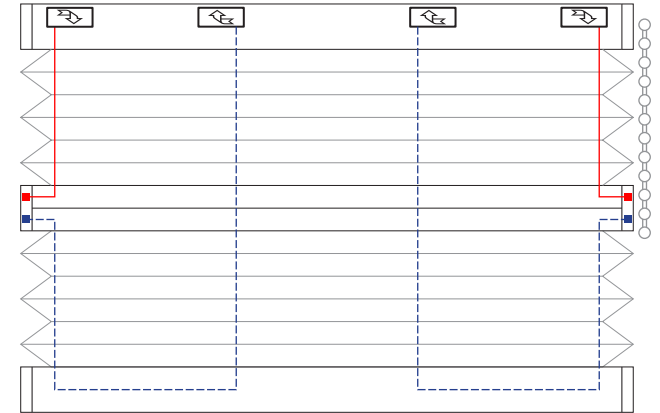

4 Schnurbohrungen/Cord boreholes/Passages de cordon

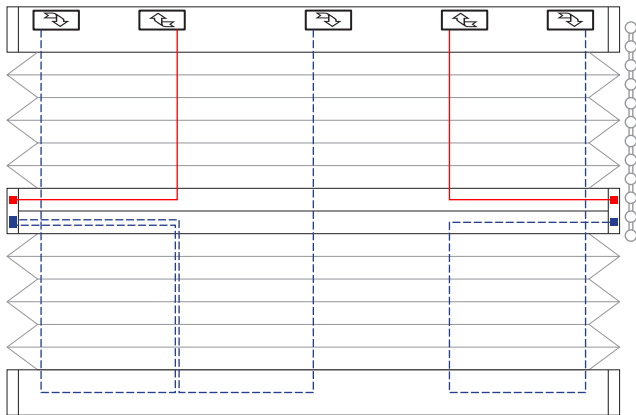

5 Schnurbohrungen/Cord boreholes/Passages de cordon

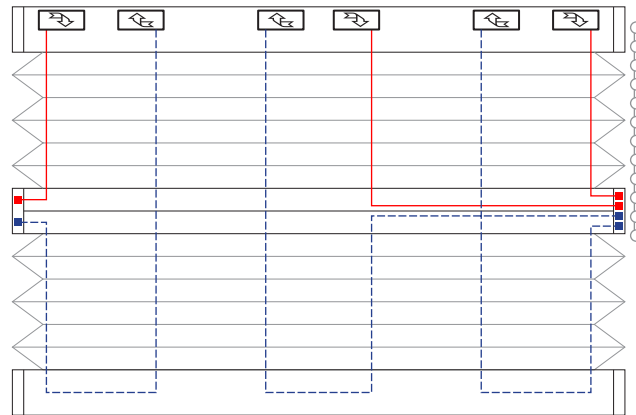

6 Schnurbohrungen/Cord boreholes/Passages de cordon

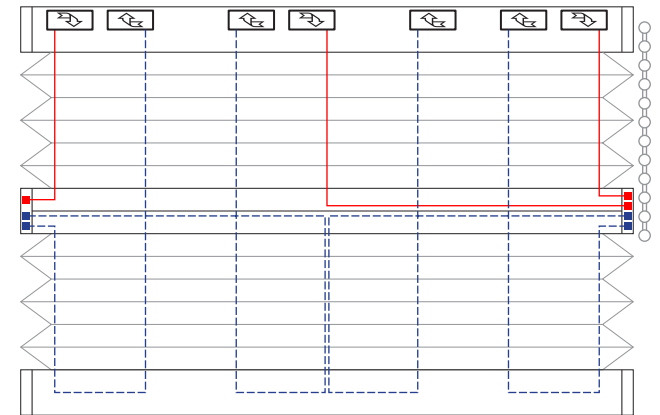

7 Schnurbohrungen/Cord boreholes/Passages de cordon



P 1822

- 1. Wickelschnur/Winding cord/Cordon d'enroulement Ø1,2 mm
- - - 2. Wickelschnur/Winding cord/Cordon d'enroulement Ø1,2 mm
- SOMFY CTS 25 Schnurwickler/Cord winder/Dévidoir de cordon
- - - Wickelschnur/Winding cord/Cordon d'enroulement Ø1,2 mm

Zugfeder/Tension spring/Ressort de traction Ø0,7 x 44 mm

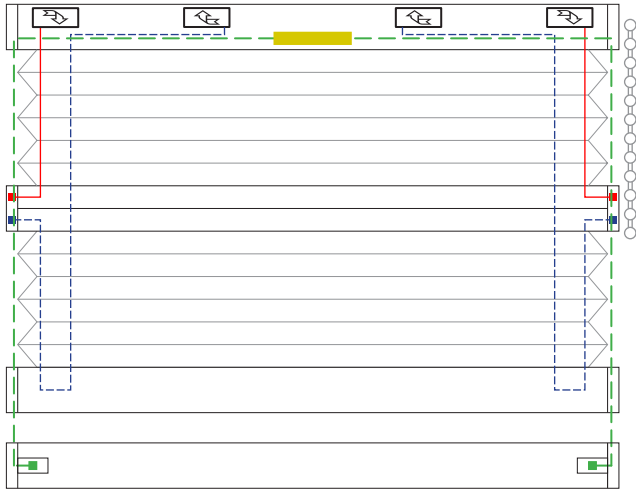

2 Schnurbohrungen/Cord boreholes/Passages de cordon

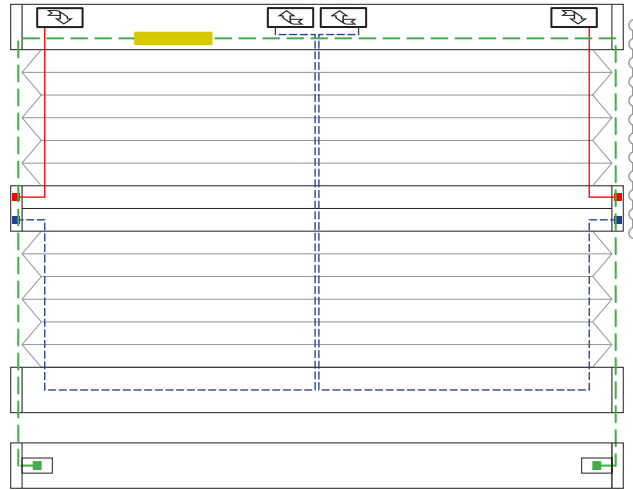

3 Schnurbohrungen/Cord boreholes/Passages de cordon

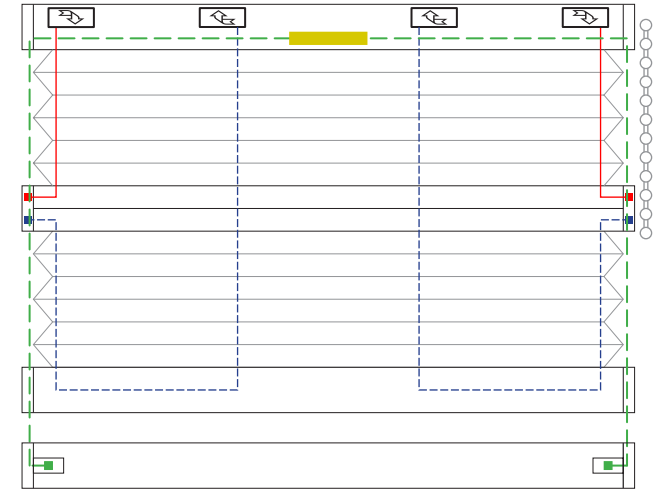

4 Schnurbohrungen/Cord boreholes/Passages de cordon



5 Schnurbohrungen/Cord boreholes/Passages de cordon

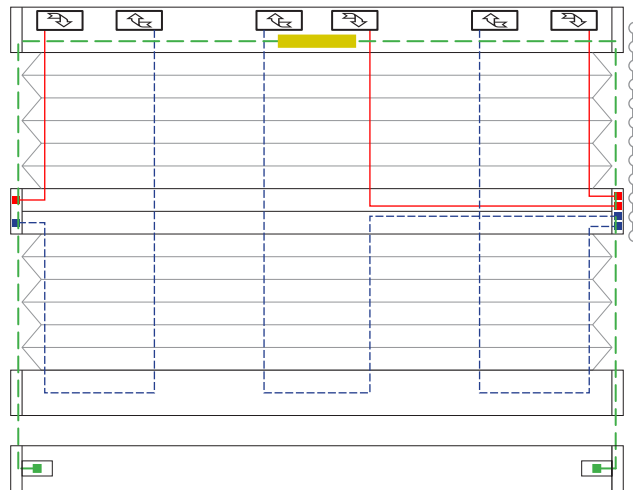

6 Schnurbohrungen/Cord boreholes/Passages de cordon

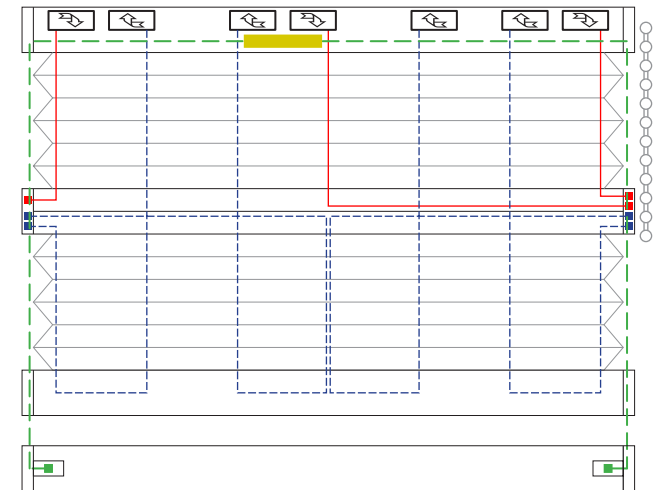

7 Schnurbohrungen/Cord boreholes/Passages de cordon



P 1825

- 1. Wickelschnur/Winding cord/Cordon d'enroulement Ø1,2 mm
- - - 2. Wickelschnur/Winding cord/Cordon d'enroulement Ø1,2 mm
- SOMFY CTS 25 Schnurwickler/Cord winder/Dévidoir de cordon
- - - Wickelschnur/Winding cord/Cordon d'enroulement Ø1,2 mm

Zugfeder/Tension spring/Ressort de traction Ø0,7 x 44 mm

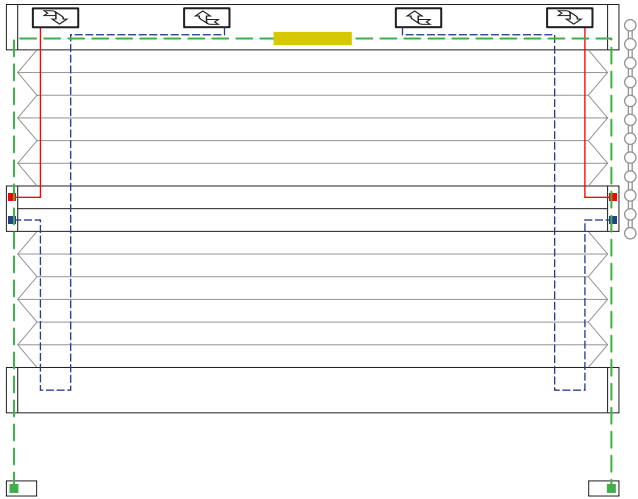

2 Schnurbohrungen/Cord boreholes/Passages de cordon



3 Schnurbohrungen/Cord boreholes/Passages de cordon

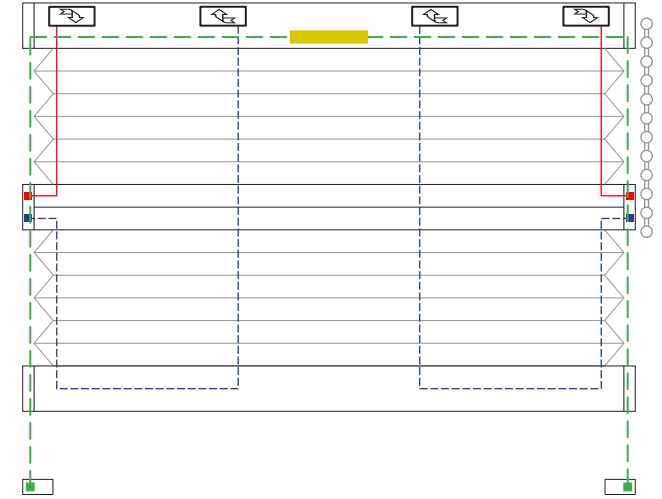

4 Schnurbohrungen/Cord boreholes/Passages de cordon

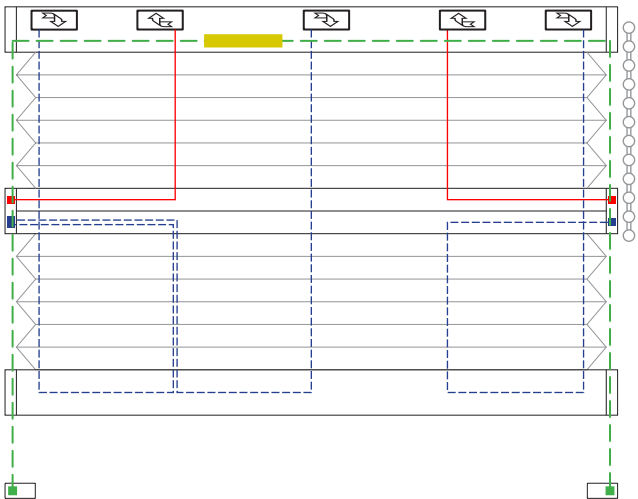

5 Schnurbohrungen/Cord boreholes/Passages de cordon

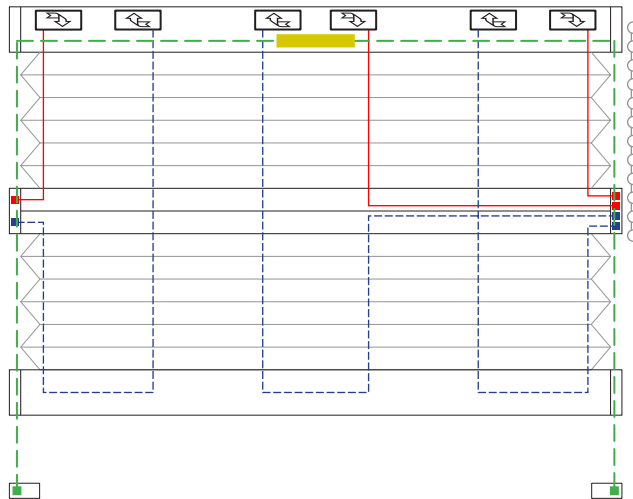

6 Schnurbohrungen/Cord boreholes/Passages de cordon

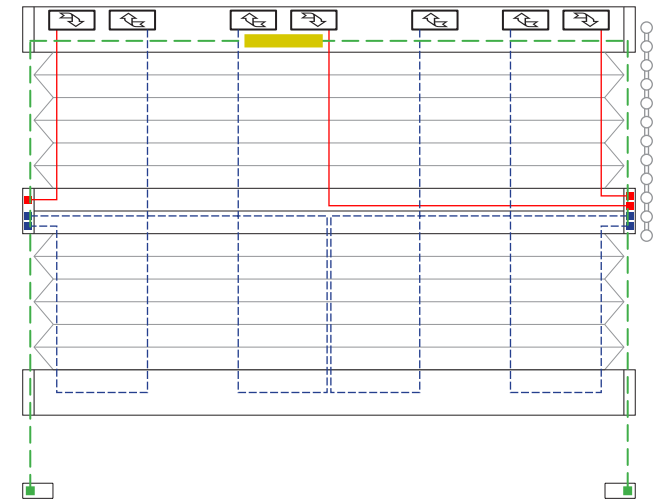

7 Schnurbohrungen/Cord boreholes/Passages de cordon



P 1830

- Wickelschnur/Winding cord/Cordon d'enroulement Ø1,2 mm
- SOMFY CTS 25 Schnurwickler/Cord winder/Dévidoir de cordon
- Spannschnur/Tension cord/Cordon de tension Ø0,8 mm
- Zugfeder/Tension spring/Ressort de traction Ø0,7 x 44 mm

Schnurspanner/Cord stretcher/Tendeur de cordon

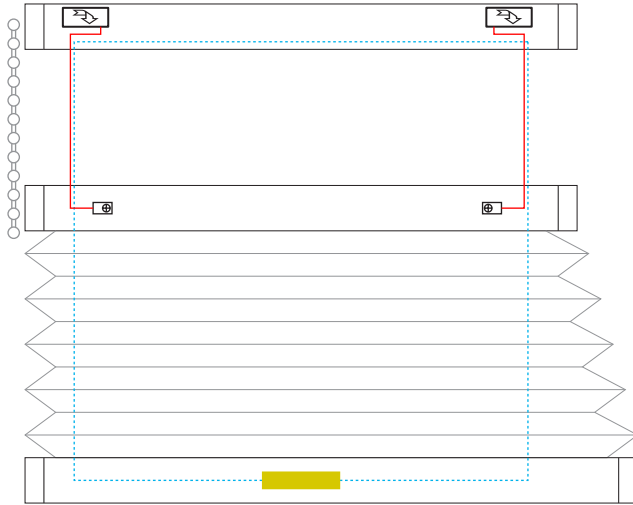

2 Schnurbohrungen/Cord boreholes/Passages de cordon

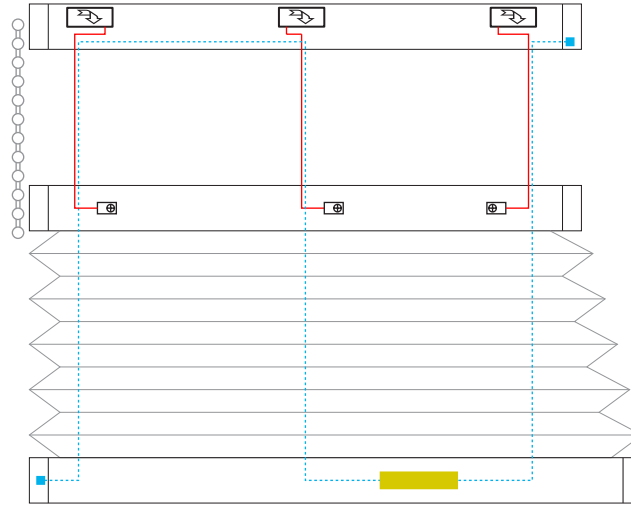

3 Schnurbohrungen/Cord boreholes/Passages de cordon

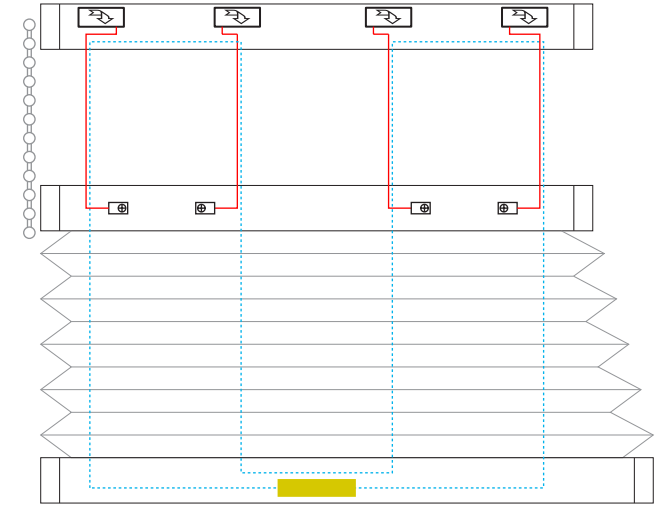

4 Schnurbohrungen/Cord boreholes/Passages de cordon

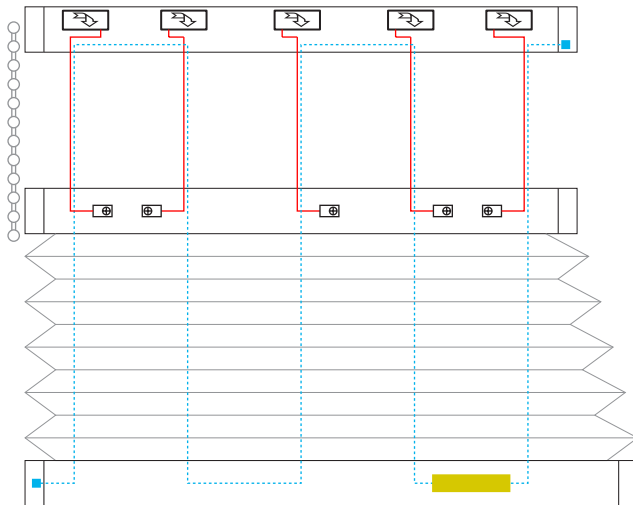

5 Schnurbohrungen/Cord boreholes/Passages de cordon

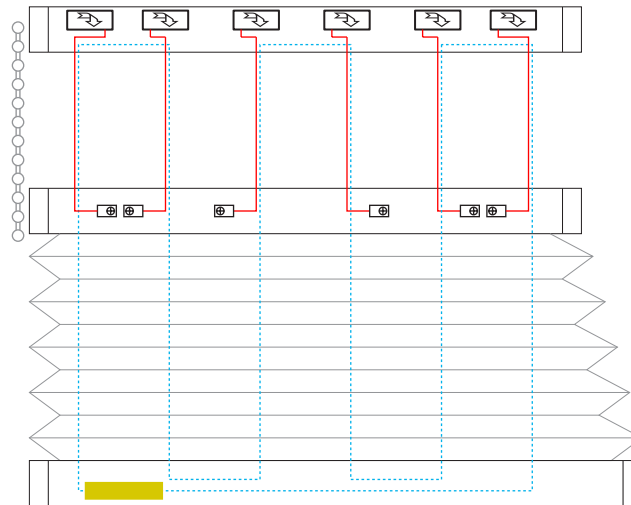

6 Schnurbohrungen/Cord boreholes/Passages de cordon

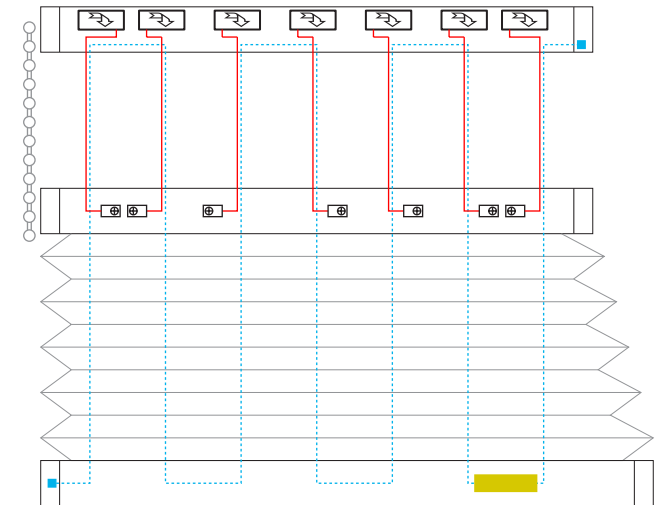

7 Schnurbohrungen/Cord boreholes/Passages de cordon



P 1841-L

- Wickelschnur/Winding cord/Cordon d'enroulement Ø1,2 mm
- 1. Plisseeschnur/Pleating cord/Cordon à plisser Ø0,8 mm
- 2. Plisseeschnur/Pleating cord/Cordon à plisser Ø0,8 mm
- SOMFY CTS 25 Schnurwickler/Cord winder/Dévidoir de cordon

- Zugfeder/Tension spring/Ressort de traction Ø0,4 x 1000 mm
- Zugfeder/Tension spring/Ressort de traction Ø0,3 x 120 mm

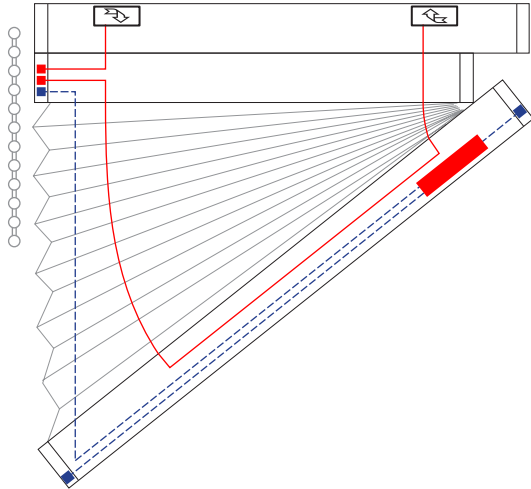

2 Schnurbohrungen/Cord boreholes/Passages de cordon

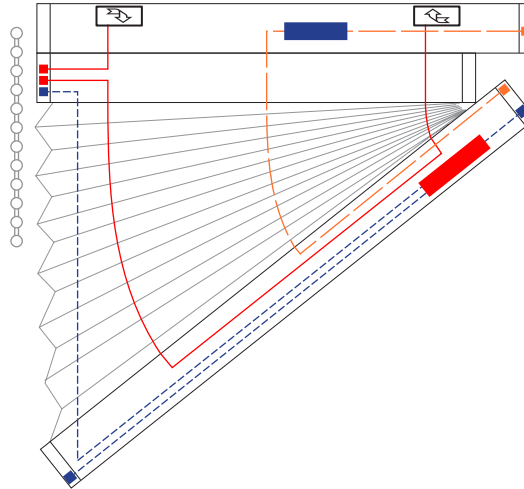

3 Schnurbohrungen/Cord boreholes/Passages de cordon

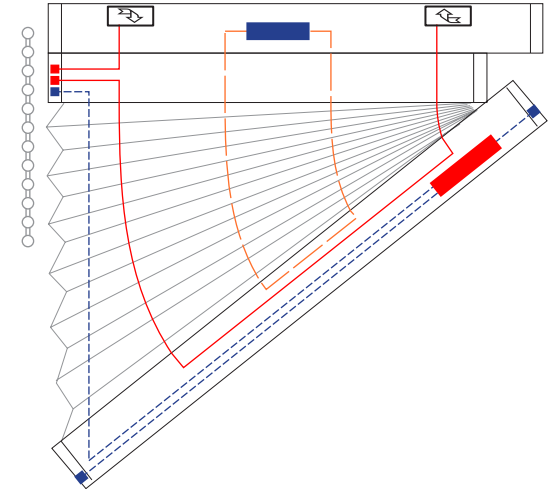

4 Schnurbohrungen/Cord boreholes/Passages de cordon

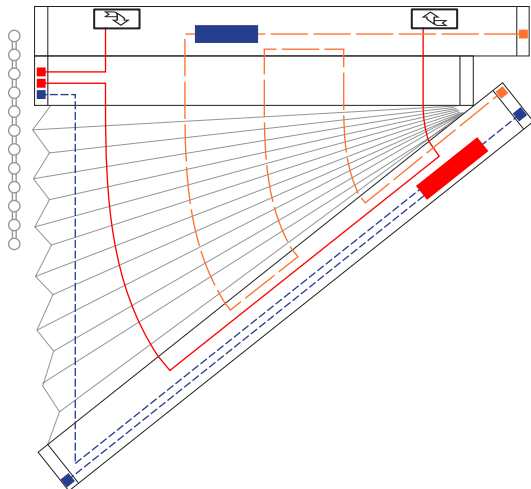

5 Schnurbohrungen/Cord boreholes/Passages de cordon

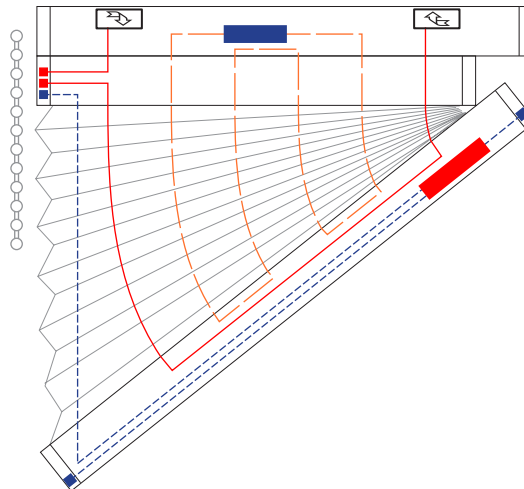

6 Schnurbohrungen/Cord boreholes/Passages de cordon

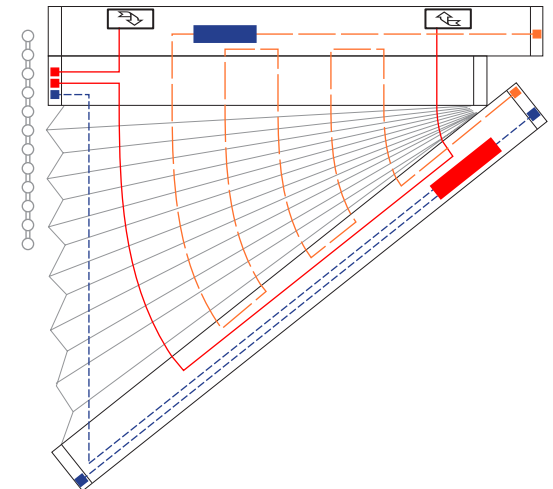

7 Schnurbohrungen/Cord boreholes/Passages de cordon



P 1841-R

- Wickelschnur/Winding cord/Cordon d'enroulement Ø1,2 mm
- 1. Plisseeschnur/Pleating cord/Cordon à plisser Ø0,8 mm
- 2. Plisseeschnur/Pleating cord/Cordon à plisser Ø0,8 mm
- SOMFY CTS 25 Schnurwickler/Cord winder/Dévidoir de cordon

- Zugfeder/Tension spring/Ressort de traction Ø0,4 x 1000 mm
- Zugfeder/Tension spring/Ressort de traction Ø0,3 x 120 mm

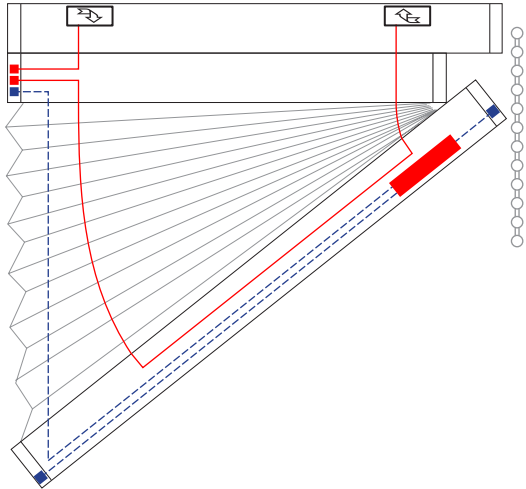

2 Schnurbohrungen/Cord boreholes/Passages de cordon

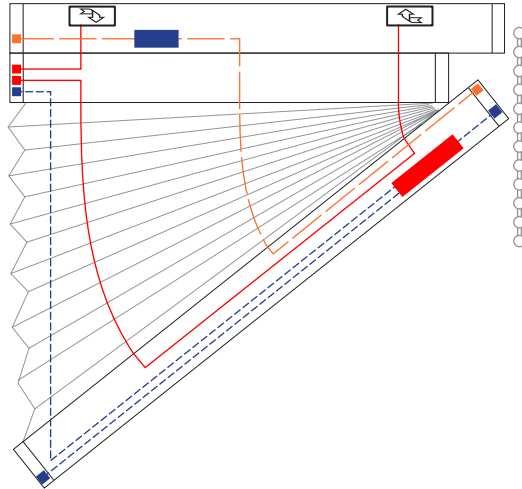

3 Schnurbohrungen/Cord boreholes/Passages de cordon

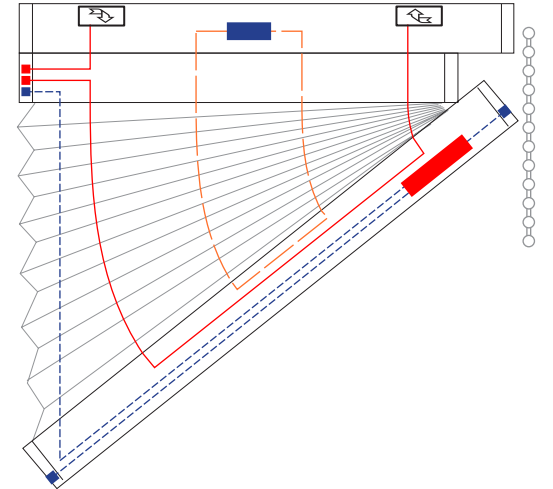

4 Schnurbohrungen/Cord boreholes/Passages de cordon

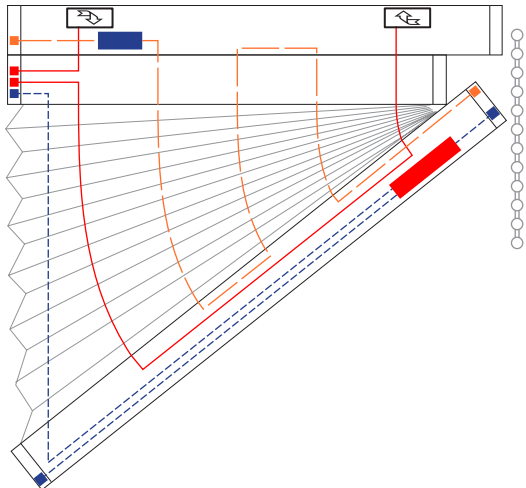

5 Schnurbohrungen/Cord boreholes/Passages de cordon

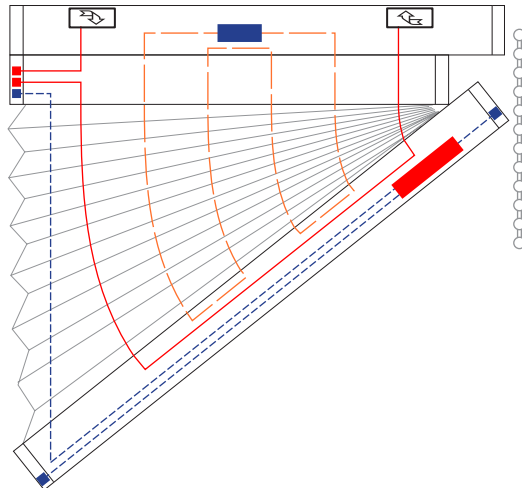

6 Schnurbohrungen/Cord boreholes/Passages de cordon

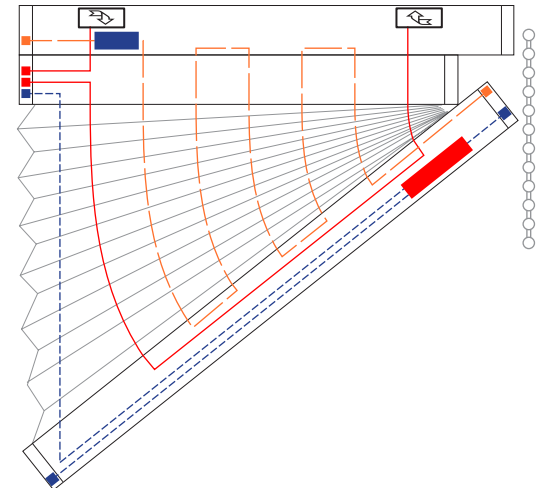

7 Schnurbohrungen/Cord boreholes/Passages de cordon



P 1902

- Wickelschnur/Winding cord/Cordon d'enroulement Ø1,2 mm
- SOMFY CTS 25 Schnurwickler/Cord winder/Dévidoir de cordon
- - - Wickelschnur/Winding cord/Cordon d'enroulement Ø1,2 mm
- Zugfeder/Tension spring/Ressort de traction Ø0,7 x 44 mm

Schnurspanner/Cord stretcher/Tendeur de cordon



2 Schnurbohrungen/Cord boreholes/Passages de cordon

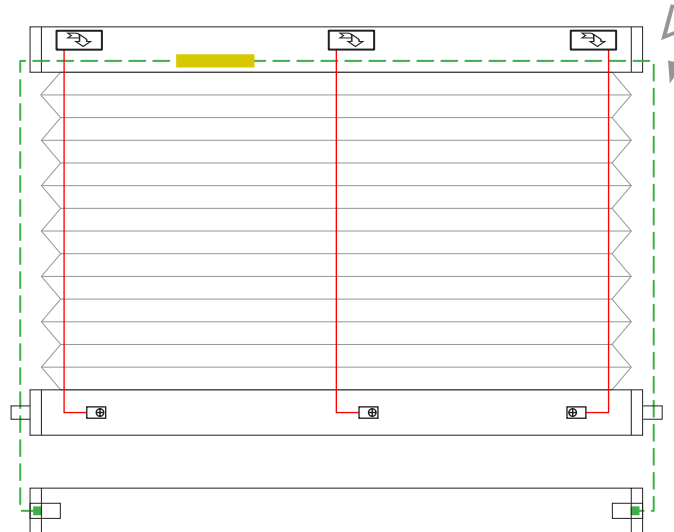

3 Schnurbohrungen/Cord boreholes/Passages de cordon

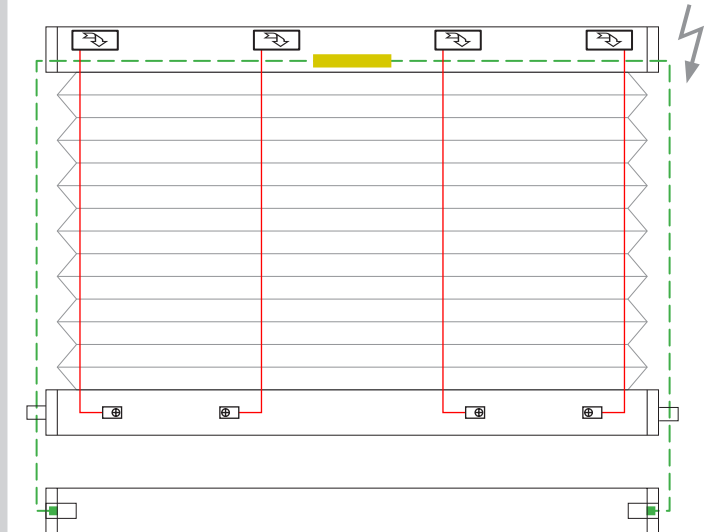

4 Schnurbohrungen/Cord boreholes/Passages de cordon

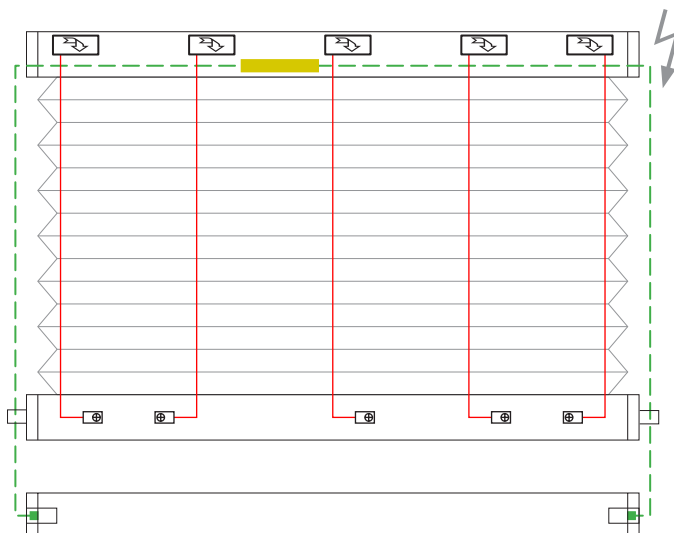

5 Schnurbohrungen/Cord boreholes/Passages de cordon

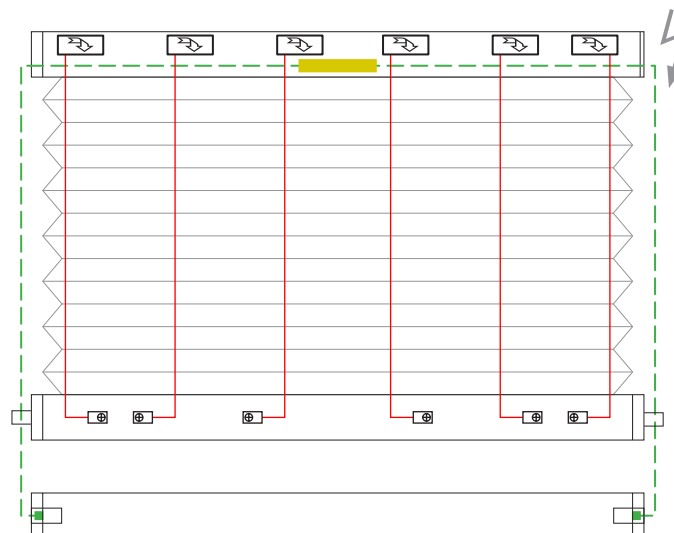

6 Schnurbohrungen/Cord boreholes/Passages de cordon



P 1910

- 1. Wickelschnur/Winding cord/Cordon d'enroulement Ø1,2 mm
- - - 2. Wickelschnur/Winding cord/Cordon d'enroulement Ø1,2 mm
- SOMFY CTS 25 Schnurwickler/Cord winder/Dévidoir de cordon
- Schnurspanner/Cord stretcher/Tendeur de cordon

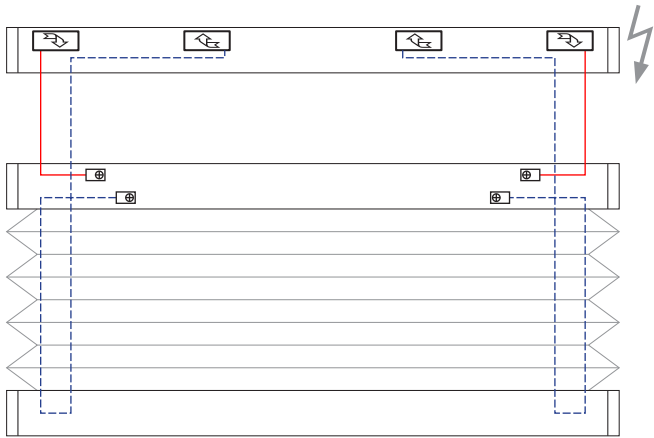

2 Schnurbohrungen/Cord boreholes/Passages de cordon

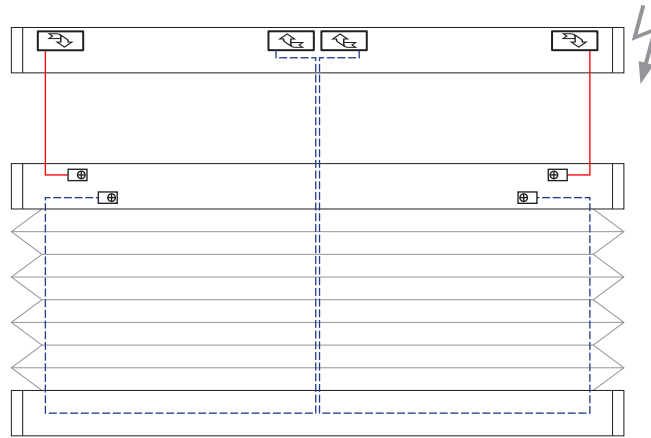

3 Schnurbohrungen/Cord boreholes/Passages de cordon

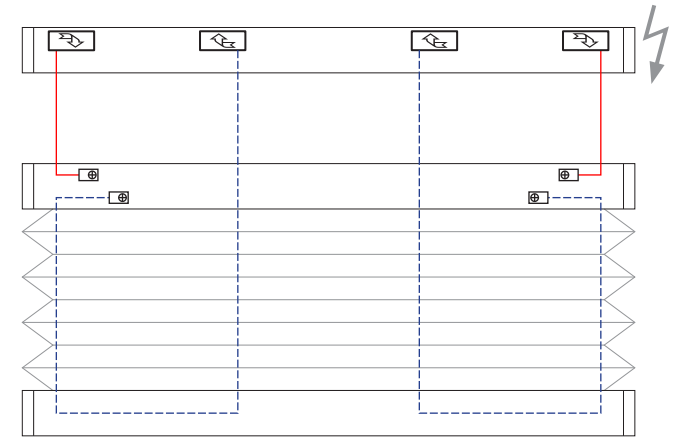

4 Schnurbohrungen/Cord boreholes/Passages de cordon

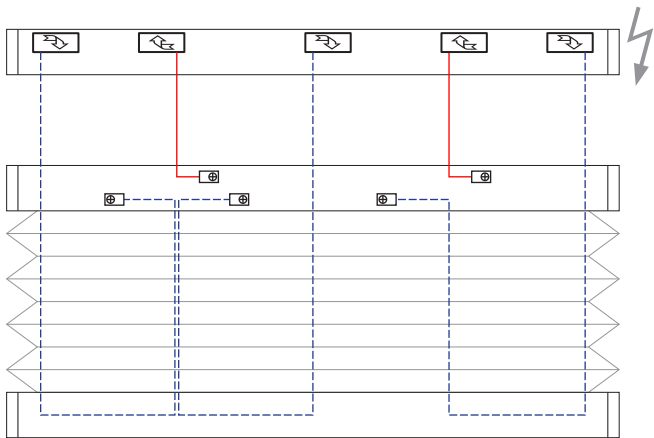

5 Schnurbohrungen/Cord boreholes/Passages de cordon

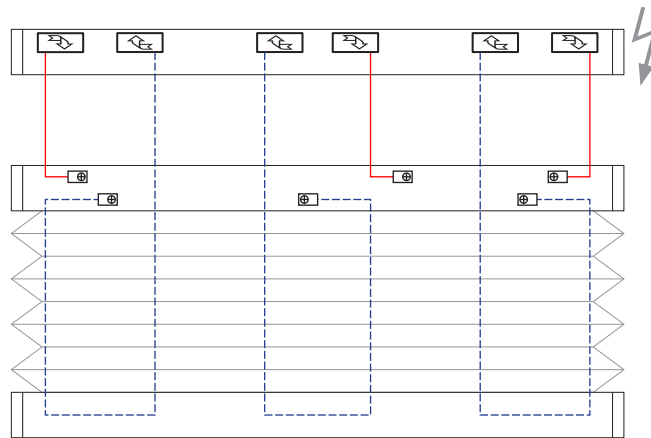

6 Schnurbohrungen/Cord boreholes/Passages de cordon

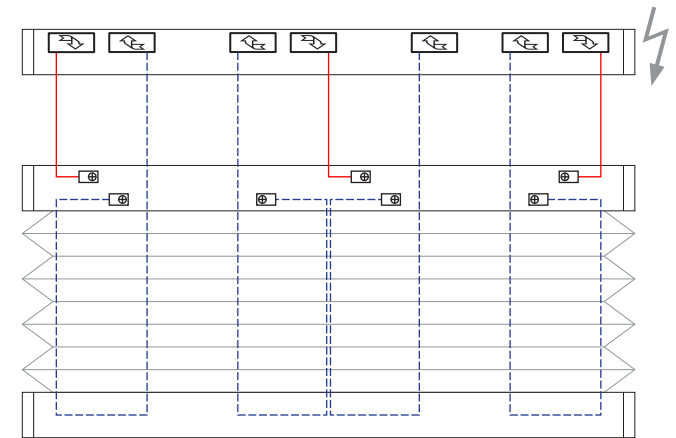

7 Schnurbohrungen/Cord boreholes/Passages de cordon



P 1912

- 1. Wickelschnur/Winding cord/Cordon d'enroulement Ø1,2 mm
- - - 2. Wickelschnur/Winding cord/Cordon d'enroulement Ø1,2 mm
- SOMFY CTS 25 Schnurwickler/Cord winder/Dévidoir de cordon
- - - Wickelschnur/Winding cord/Cordon d'enroulement Ø1,2 mm

- Zugfeder/Tension spring/Ressort de traction Ø0,7 x 44 mm
- Schnurspanner/Cord stretcher/Tendeur de cordon

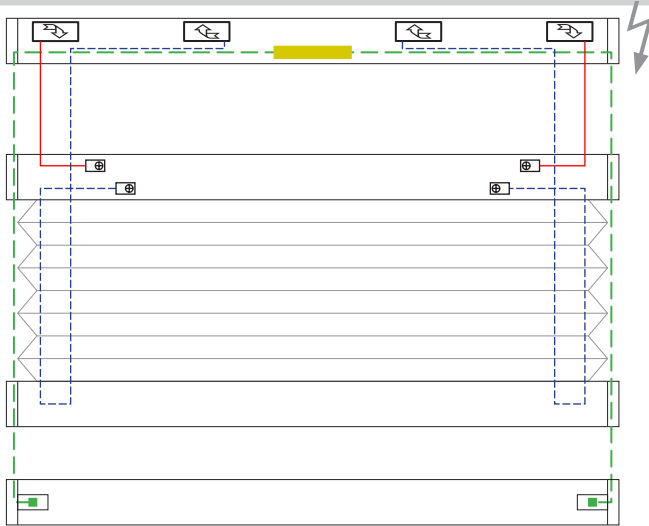

2 Schnurbohrungen/Cord boreholes/Passages de cordon

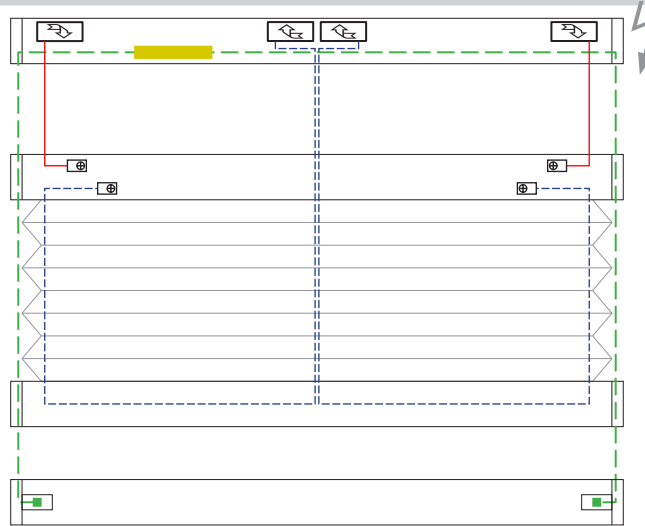

3 Schnurbohrungen/Cord boreholes/Passages de cordon



4 Schnurbohrungen/Cord boreholes/Passages de cordon

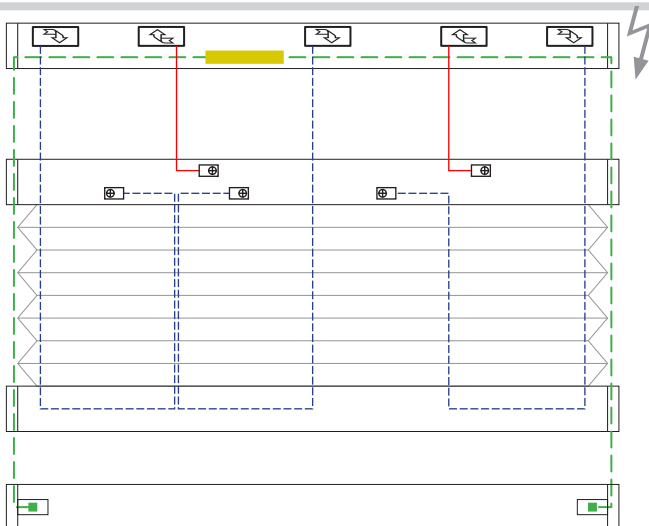

5 Schnurbohrungen/Cord boreholes/Passages de cordon

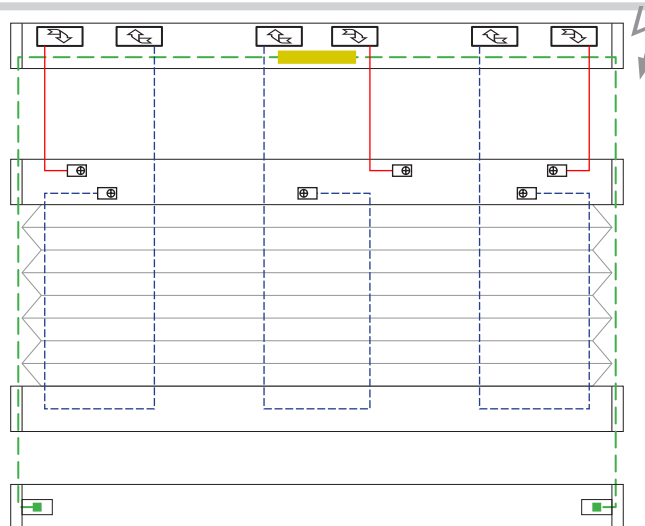

6 Schnurbohrungen/Cord boreholes/Passages de cordon

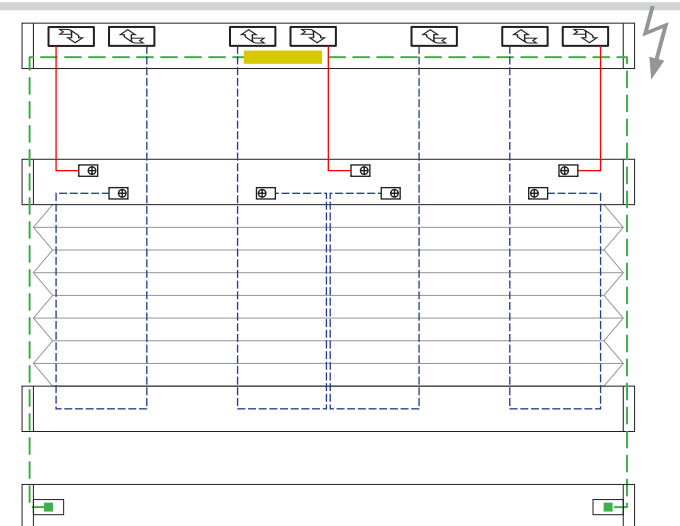

7 Schnurbohrungen/Cord boreholes/Passages de cordon



P 1915

- 1. Wickelschnur/Winding cord/Cordon d'enroulement Ø1,2 mm
- - - 2. Wickelschnur/Winding cord/Cordon d'enroulement Ø1,2 mm
- SOMFY CTS 25 Schnurwickler/Cord winder/Dévidoir de cordon
- - - Wickelschnur/Winding cord/Cordon d'enroulement Ø1,2 mm

- Zugfeder/Tension spring/Ressort de traction Ø0,7 x 44 mm
- Schnurspanner/Cord stretcher/Tendeur de cordon



2 Schnurbohrungen/Cord boreholes/Passages de cordon



3 Schnurbohrungen/Cord boreholes/Passages de cordon



4 Schnurbohrungen/Cord boreholes/Passages de cordon

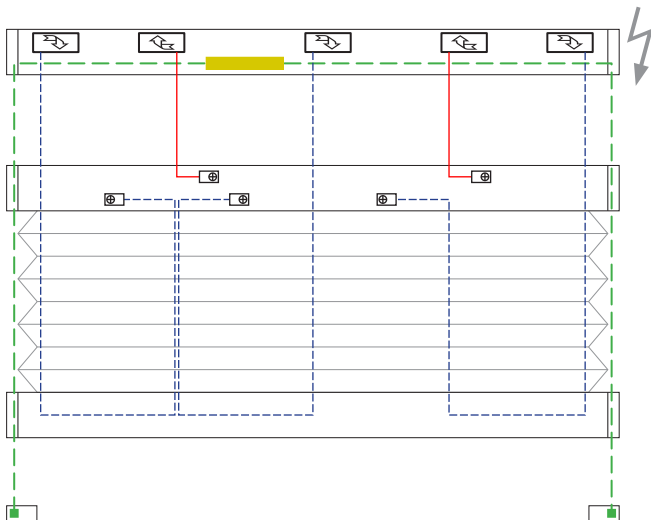

5 Schnurbohrungen/Cord boreholes/Passages de cordon

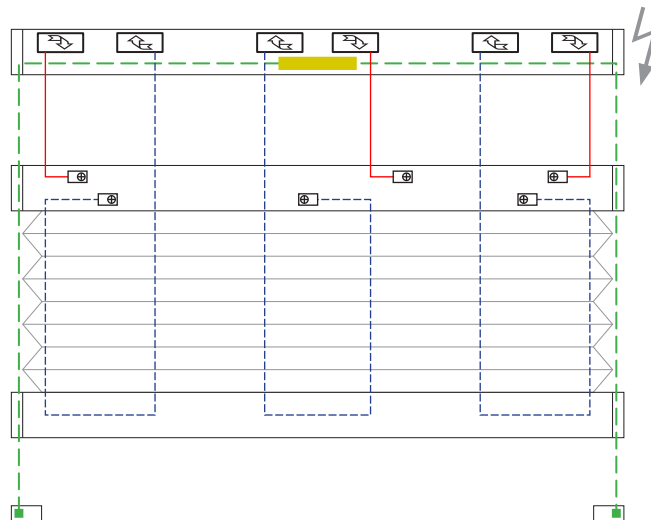

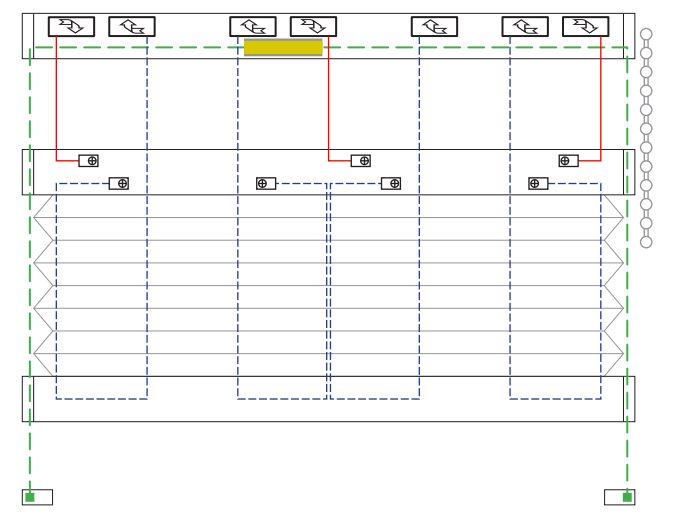

6 Schnurbohrungen/Cord boreholes/Passages de cordon



7 Schnurbohrungen/Cord boreholes/Passages de cordon



P 1920

-  1. Wickelschnur/Winding cord/Cordon d'enroulement Ø1,2 mm
-  2. Wickelschnur/Winding cord/Cordon d'enroulement Ø1,2 mm
-  SOMFY CTS 25 Schnurwickler/Cord winder/Dévidoir de cordon

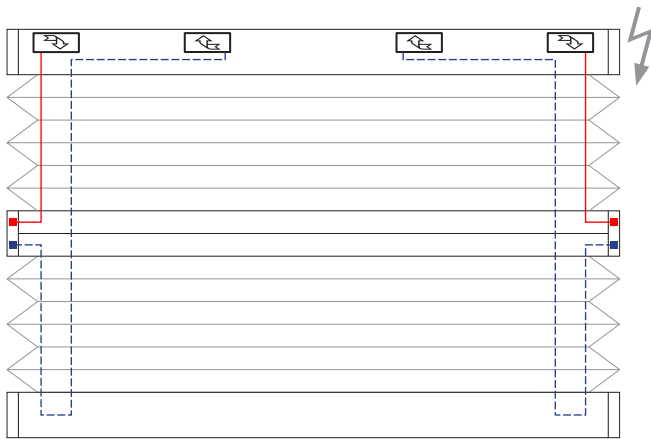

2 Schnurbohrungen/Cord boreholes/Passages de cordon

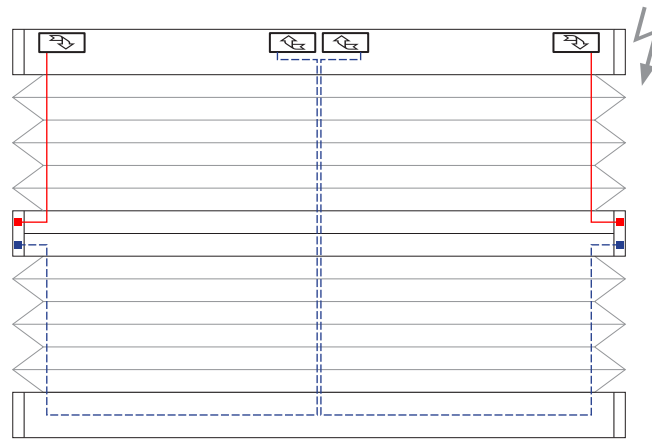

3 Schnurbohrungen/Cord boreholes/Passages de cordon

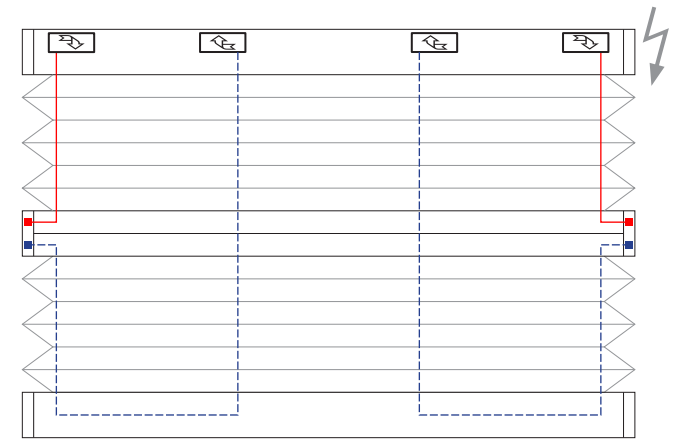

4 Schnurbohrungen/Cord boreholes/Passages de cordon

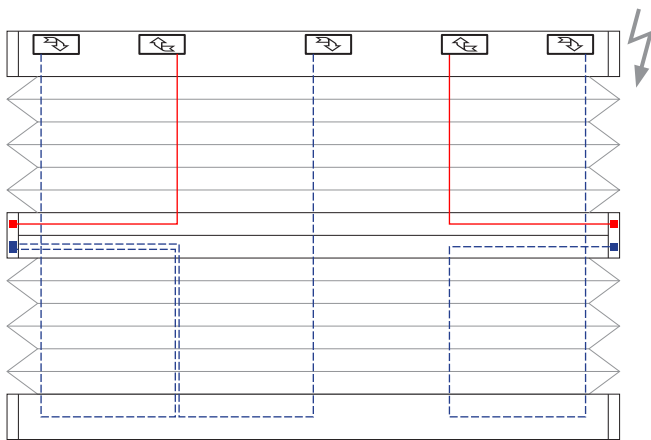

5 Schnurbohrungen/Cord boreholes/Passages de cordon

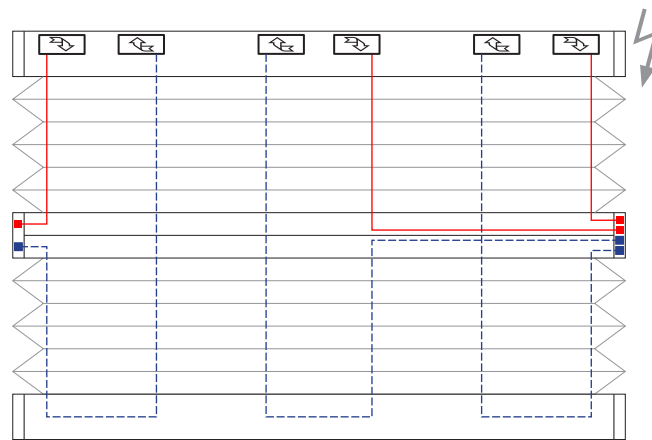

6 Schnurbohrungen/Cord boreholes/Passages de cordon

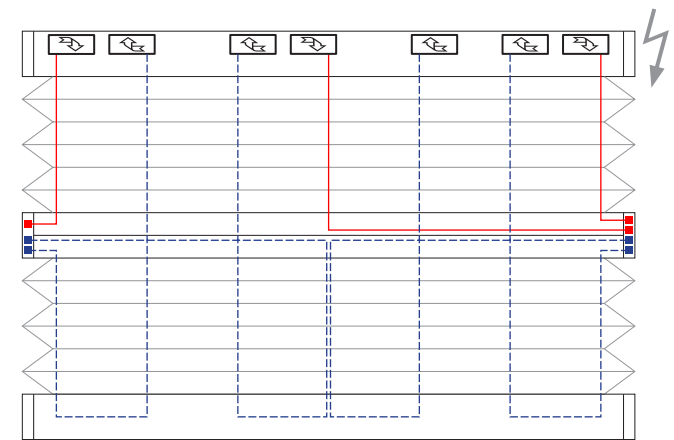

7 Schnurbohrungen/Cord boreholes/Passages de cordon



P 1922

- 1. Wickelschnur/Winding cord/Cordon d'enroulement Ø1,2 mm
- - - 2. Wickelschnur/Winding cord/Cordon d'enroulement Ø1,2 mm
- SOMFY CTS 25 Schnurwickler/Cord winder/Dévidoir de cordon
- - - Wickelschnur/Winding cord/Cordon d'enroulement Ø1,2 mm

Zugfeder/Tension spring/Ressort de traction Ø0,7 x 44 mm

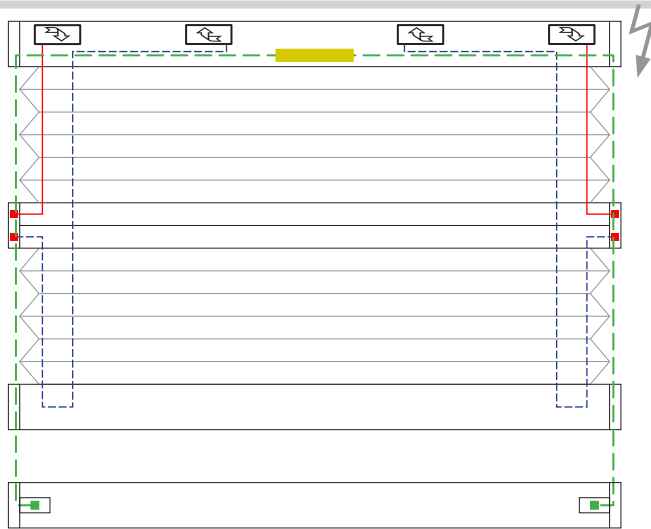

2 Schnurbohrungen/Cord boreholes/Passages de cordon

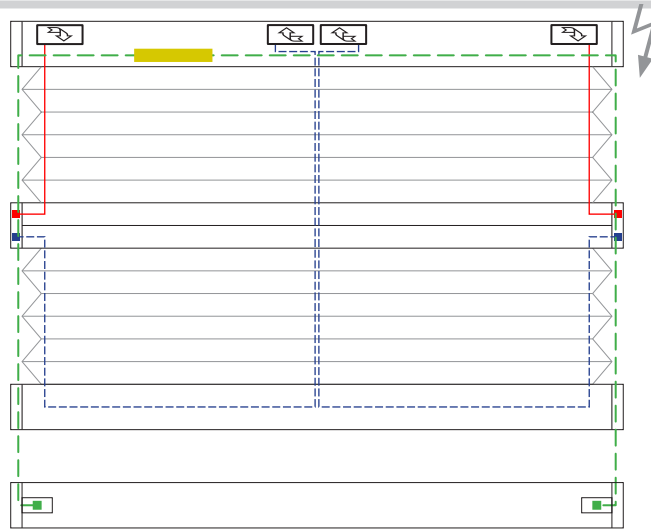

3 Schnurbohrungen/Cord boreholes/Passages de cordon



4 Schnurbohrungen/Cord boreholes/Passages de cordon

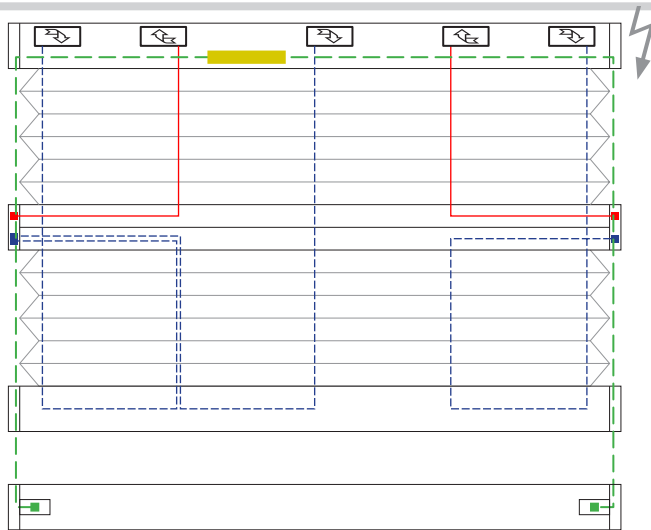

5 Schnurbohrungen/Cord boreholes/Passages de cordon

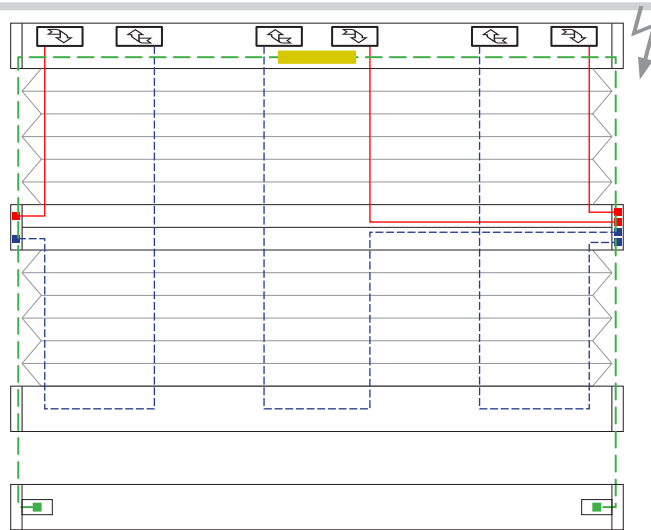

6 Schnurbohrungen/Cord boreholes/Passages de cordon

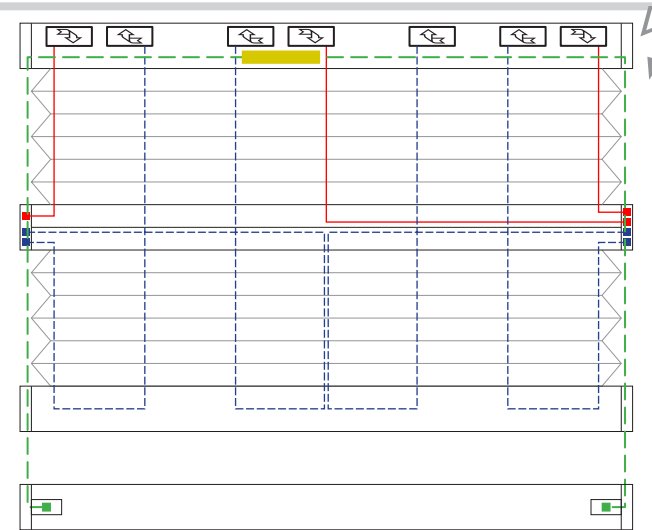

7 Schnurbohrungen/Cord boreholes/Passages de cordon



P 1925

- 1. Wickelschnur/Winding cord/Cordon d'enroulement Ø1,2 mm
- - - 2. Wickelschnur/Winding cord/Cordon d'enroulement Ø1,2 mm
- SOMFY CTS 25 Schnurwickler/Cord winder/Dévidoir de cordon
- - - Wickelschnur/Winding cord/Cordon d'enroulement Ø1,2 mm

Zugfeder/Tension spring/Ressort de traction Ø0,7 x 44 mm



2 Schnurbohrungen/Cord boreholes/Passages de cordon



3 Schnurbohrungen/Cord boreholes/Passages de cordon



4 Schnurbohrungen/Cord boreholes/Passages de cordon



5 Schnurbohrungen/Cord boreholes/Passages de cordon

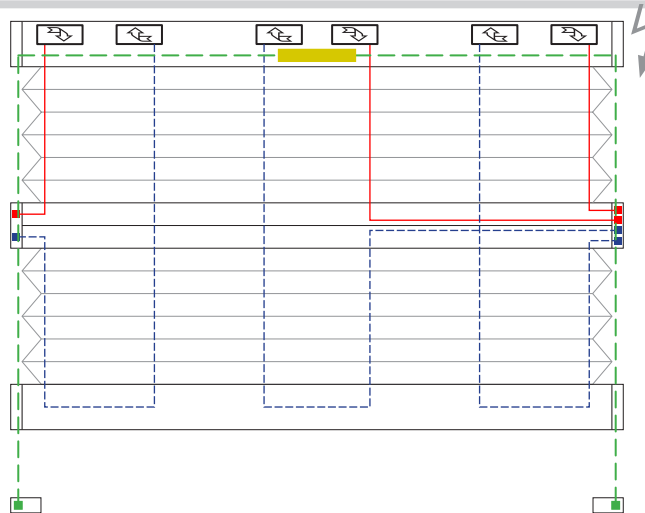

6 Schnurbohrungen/Cord boreholes/Passages de cordon

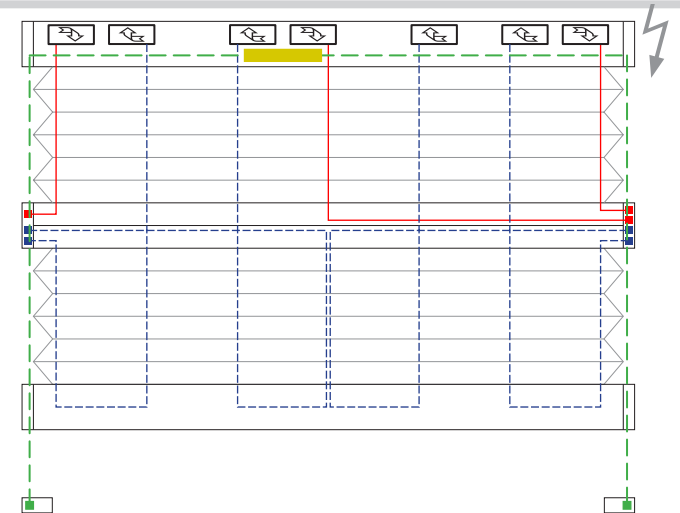

7 Schnurbohrungen/Cord boreholes/Passages de cordon



P 1930

- Wickelschnur/Winding cord/Cordon d'enroulement Ø1,2 mm
- SOMFY CTS 25 Schnurwickler/Cord winder/Dévidoir de cordon
- Spannschnur/Tension cord/Cordon de tension Ø0,8 mm
- Zugfeder/Tension spring/Ressort de traction Ø0,7 x 44 mm

Schnurspanner/Cord stretcher/Tendeur de cordon

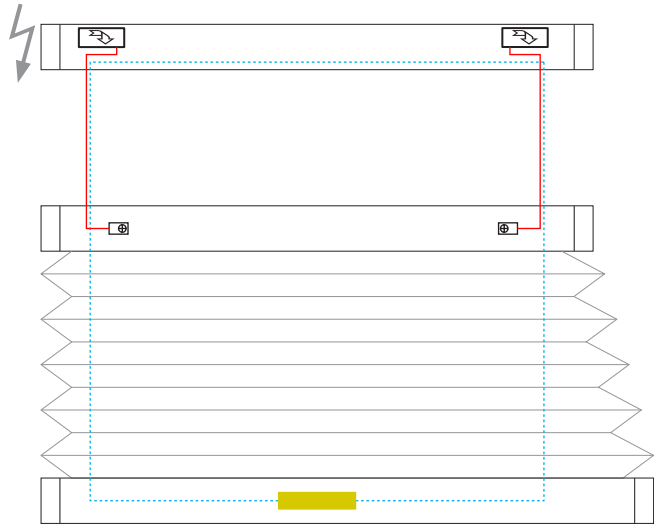

2 Schnurbohrungen/Cord boreholes/Passages de cordon

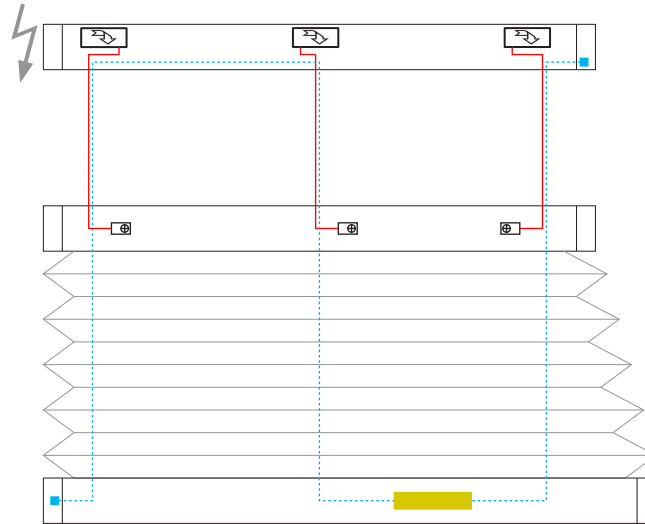

3 Schnurbohrungen/Cord boreholes/Passages de cordon

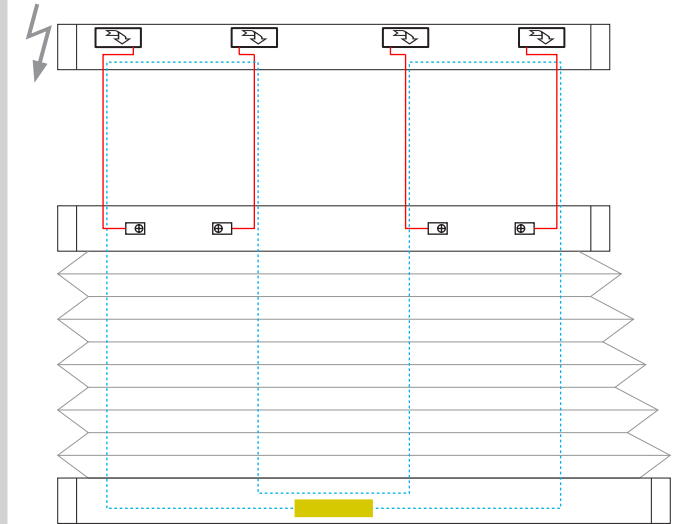

4 Schnurbohrungen/Cord boreholes/Passages de cordon

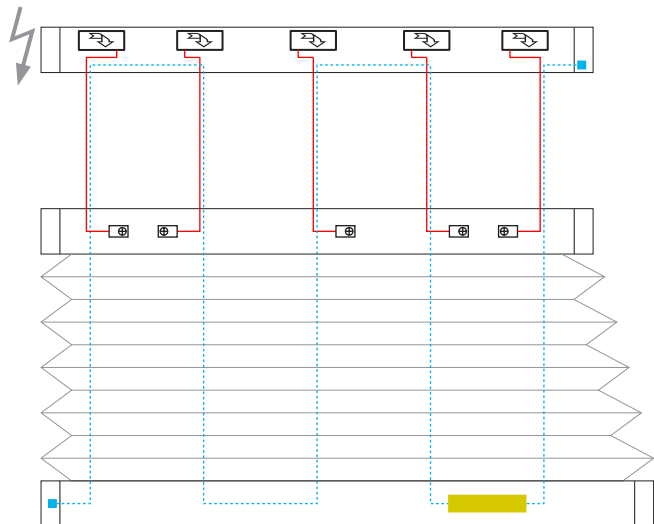

5 Schnurbohrungen/Cord boreholes/Passages de cordon

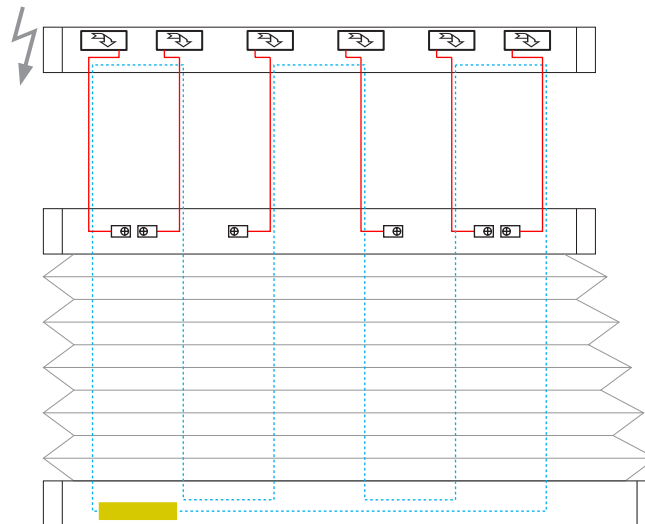

6 Schnurbohrungen/Cord boreholes/Passages de cordon



P 1940
30° - 60°

- 1. Wickelschnur/Winding cord/Cordon d'enroulement Ø1,2 mm
- - - 2. Wickelschnur/Winding cord/Cordon d'enroulement Ø1,2 mm
- SOMFY CTS 25 Schnurwickler/Cord winder/Dévidoir de cordon
- Zugfeder/Tension spring/Ressort de traction Ø0,4 x 44 mm

Schnurspanner/Cord stretcher/Tendeur de cordon

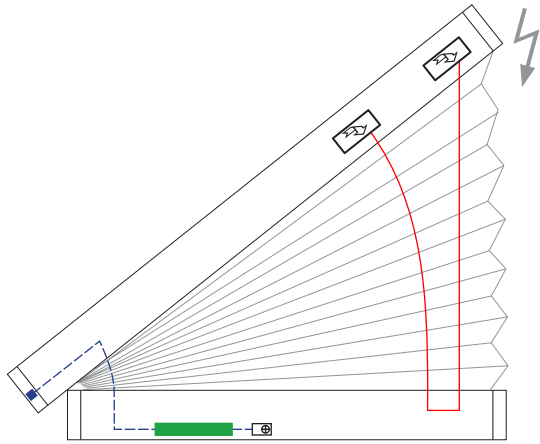

2 Schnurbohrungen/Cord boreholes/Passages de cordon

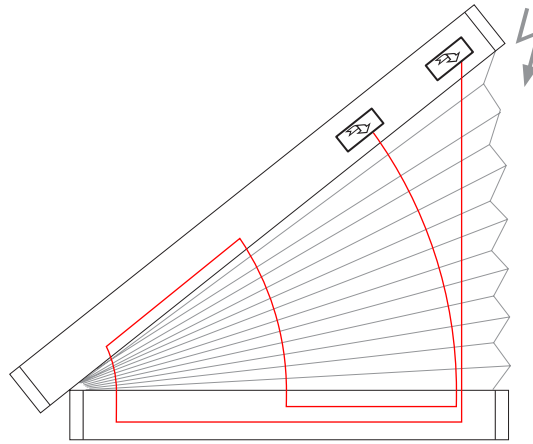

3 Schnurbohrungen/Cord boreholes/Passages de cordon

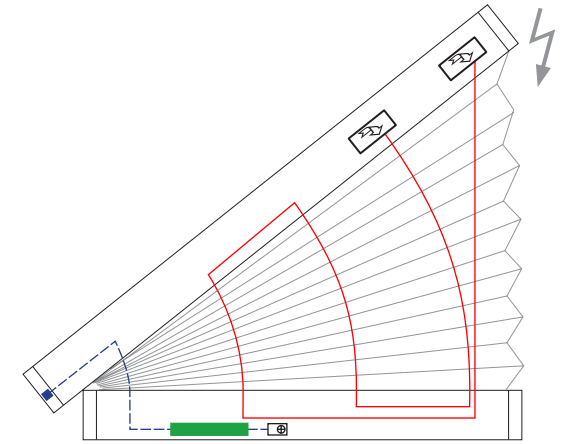

4 Schnurbohrungen/Cord boreholes/Passages de cordon

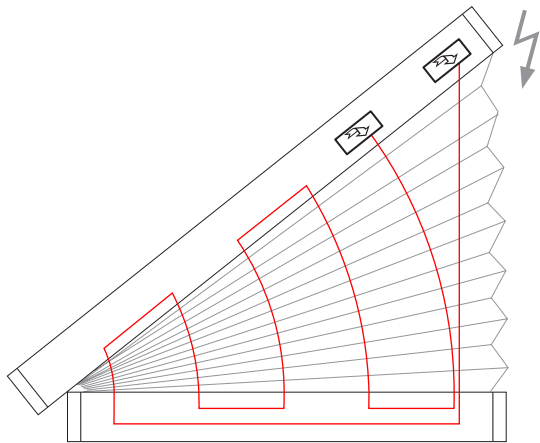

5 Schnurbohrungen/Cord boreholes/Passages de cordon

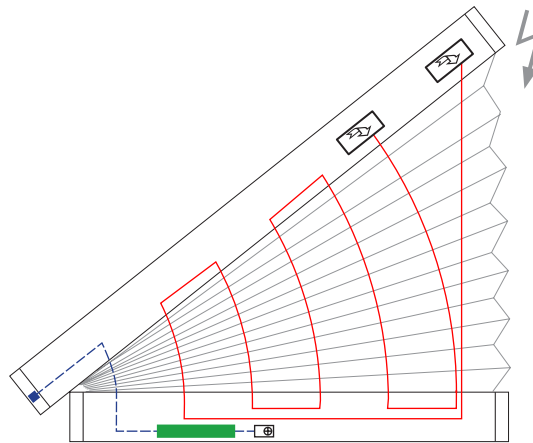

6 Schnurbohrungen/Cord boreholes/Passages de cordon

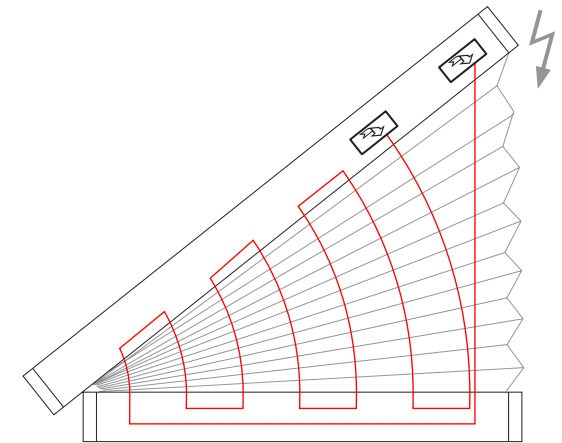

7 Schnurbohrungen/Cord boreholes/Passages de cordon



P 1940
< 30°

- 1. Wickelschnur/Winding cord/Cordon d'enroulement Ø1,2 mm
- - - 2. Wickelschnur/Winding cord/Cordon d'enroulement Ø1,2 mm
- SOMFY CTS 25 Schnurwickler/Cord winder/Dévidoir de cordon
- Zugfeder/Tension spring/Ressort de traction Ø0,4 x 44 mm

Schnurspanner/Cord stretcher/Tendeur de cordon

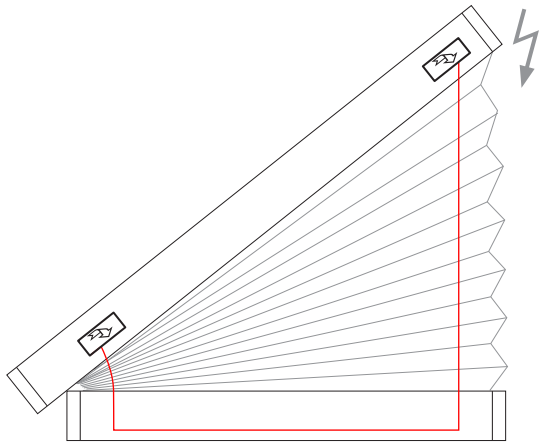

2 Schnurbohrungen/Cord boreholes/Passages de cordon

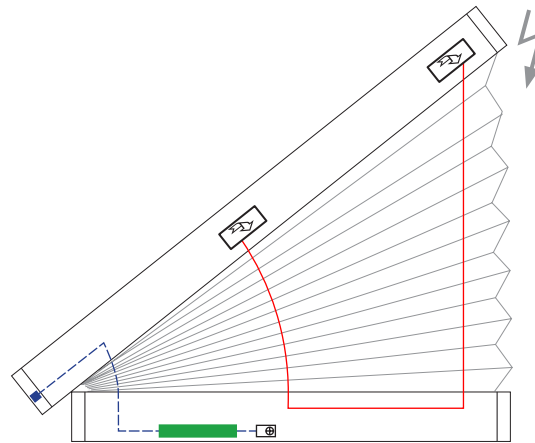

3 Schnurbohrungen/Cord boreholes/Passages de cordon

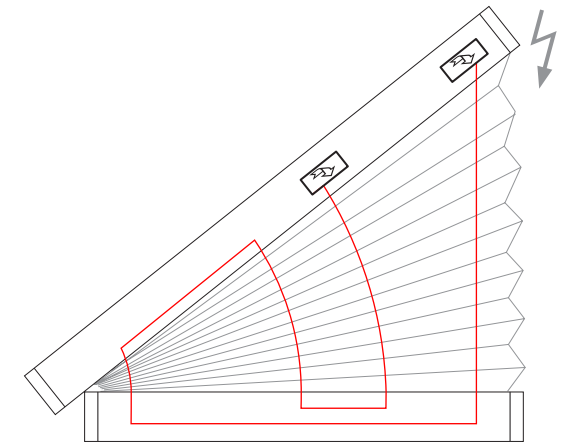

4 Schnurbohrungen/Cord boreholes/Passages de cordon

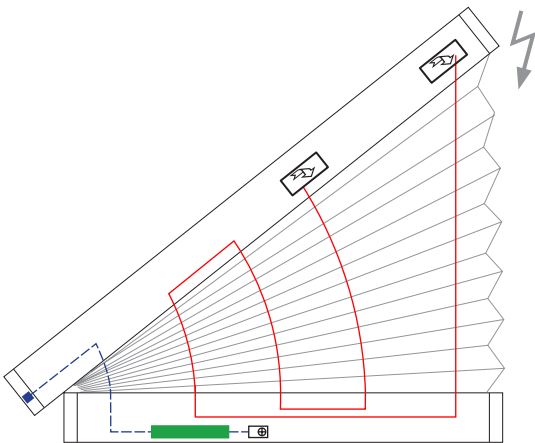

5 Schnurbohrungen/Cord boreholes/Passages de cordon

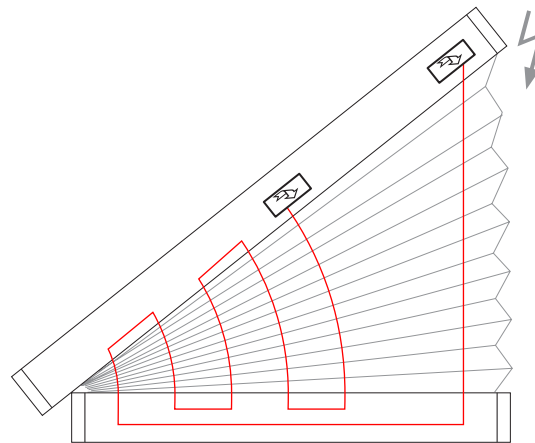

6 Schnurbohrungen/Cord boreholes/Passages de cordon



P 1941

- Wickelschnur/Winding cord/Cordon d'enroulement Ø1,2 mm
- - - 1. Plisseeschnur/Pleating cord/Cordon à plisser Ø0,8 mm
- - - 2. Plisseeschnur/Pleating cord/Cordon à plisser Ø0,8 mm
- SOMFY CTS 25 Schnurwickler/Cord winder/Dévidoir de cordon

- Zugfeder/Tension spring/Ressort de traction Ø0,4 x 1000 mm
- Zugfeder/Tension spring/Ressort de traction Ø0,3 x 120 mm

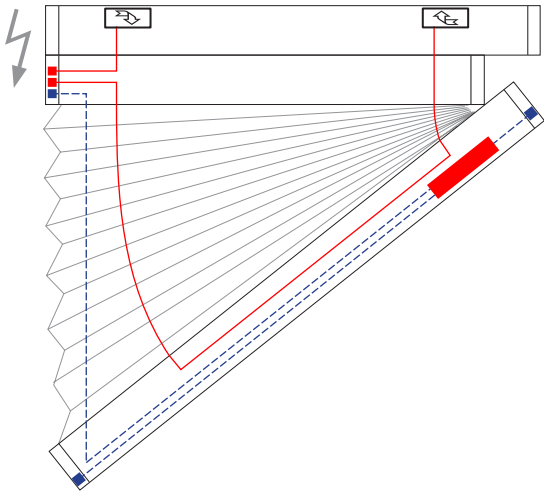

2 Schnurbohrungen/Cord boreholes/Passages de cordon

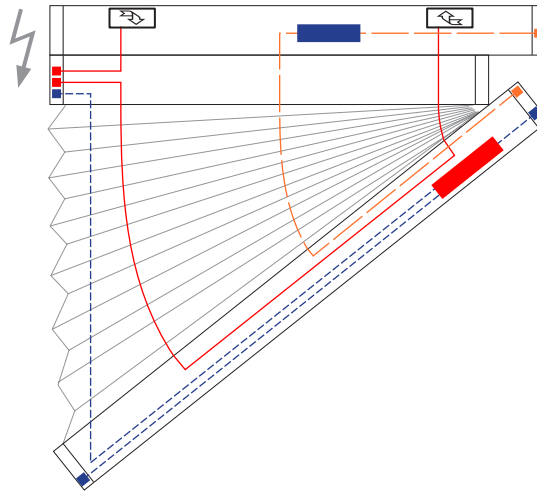

3 Schnurbohrungen/Cord boreholes/Passages de cordon

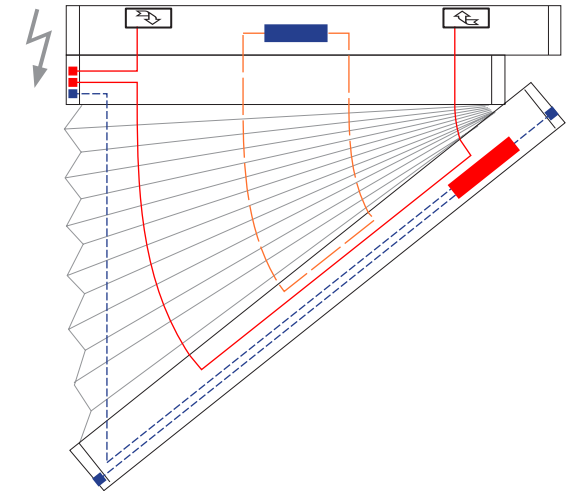

4 Schnurbohrungen/Cord boreholes/Passages de cordon

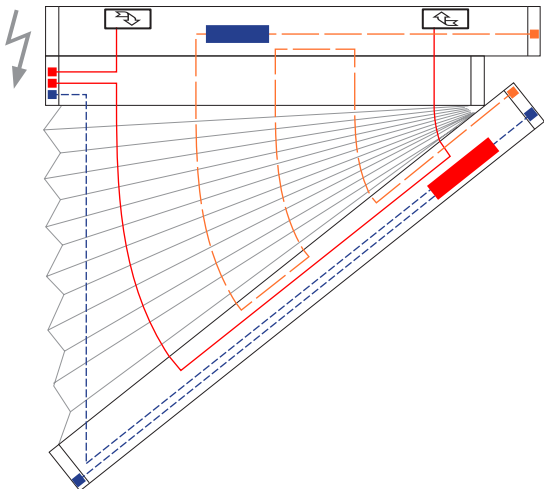

5 Schnurbohrungen/Cord boreholes/Passages de cordon

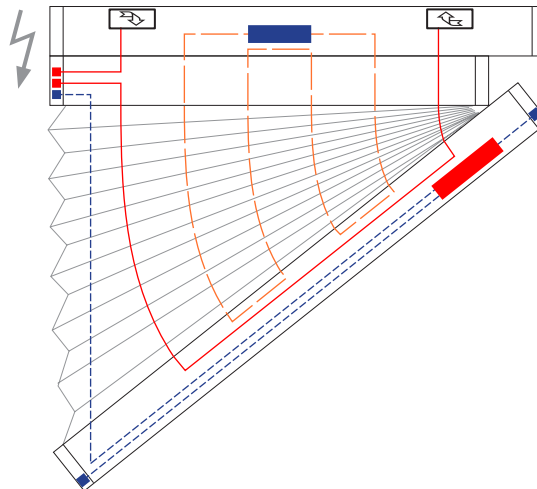

6 Schnurbohrungen/Cord boreholes/Passages de cordon

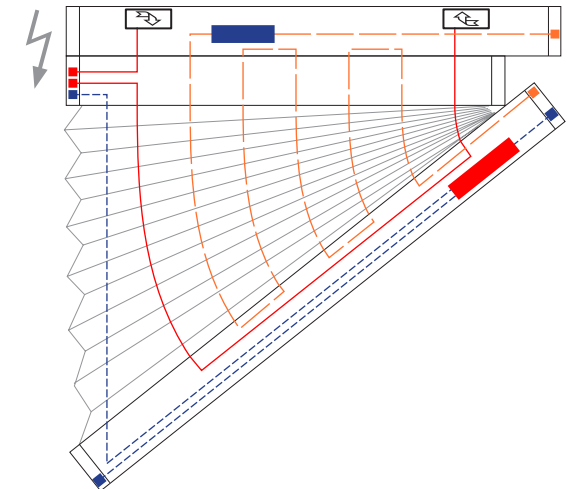

7 Schnurbohrungen/Cord boreholes/Passages de cordon



P 1001

- 1. Plisseeschnur/Pleating cord/Cordon à plisser Ø0,8 mm
- Zugfeder/Tension spring/Ressort de traction Ø0,7 x 44 mm
- ☐ Schnurspanner/Cord stretcher/Tendeur de cordon



2 Schnurbohrungen/Cord boreholes/Passages de cordon

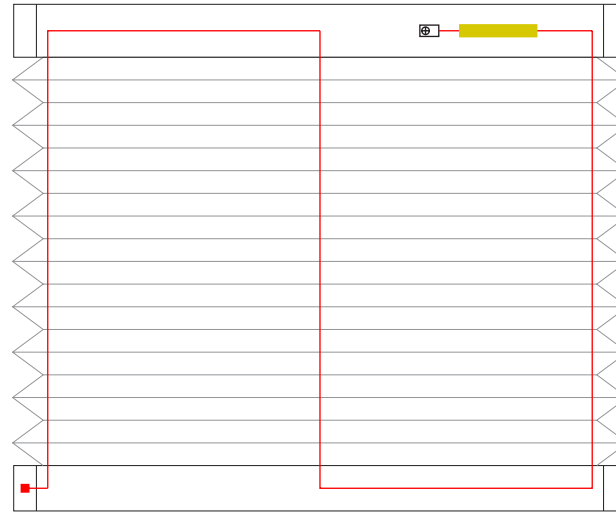

3 Schnurbohrungen/Cord boreholes/Passages de cordon



4 Schnurbohrungen/Cord boreholes/Passages de cordon

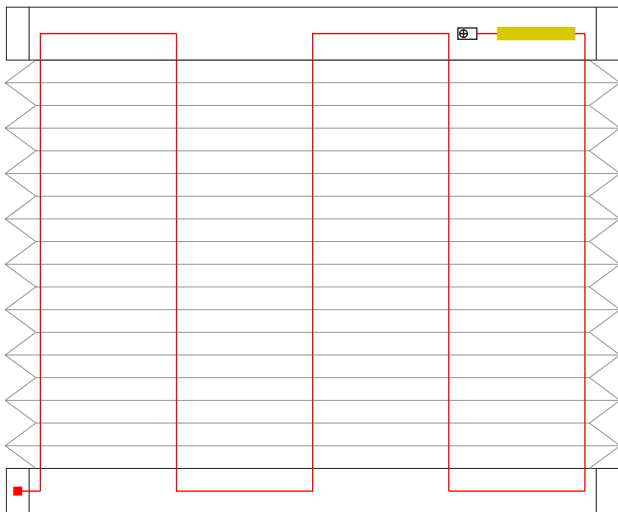

5 Schnurbohrungen/Cord boreholes/Passages de cordon



6 Schnurbohrungen/Cord boreholes/Passages de cordon

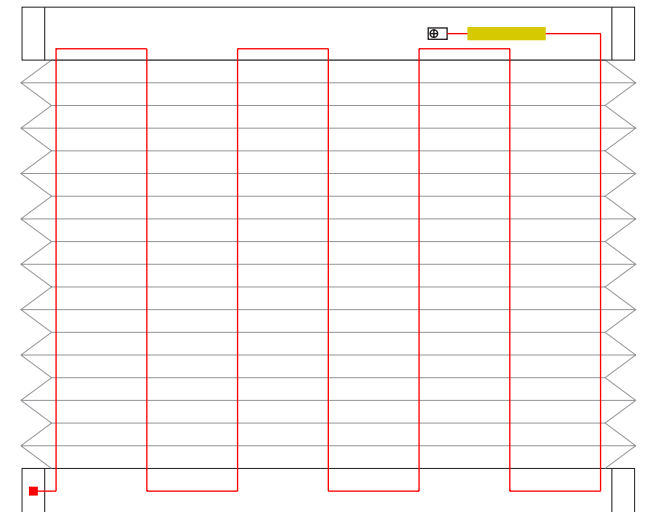

7 Schnurbohrungen/Cord boreholes/Passages de cordon



P 1036

- 1. Plisseeschnur/Pleating cord/Cordon à plisser Ø0,8 mm
- - - 2. Plisseeschnur/Pleating cord/Cordon à plisser Ø0,8 mm
- Zugfeder/Tension spring/Ressort de traction Ø0,7 x 44 mm
- ⊗ Schnurspanner/Cord stretcher/Tendeur de cordon

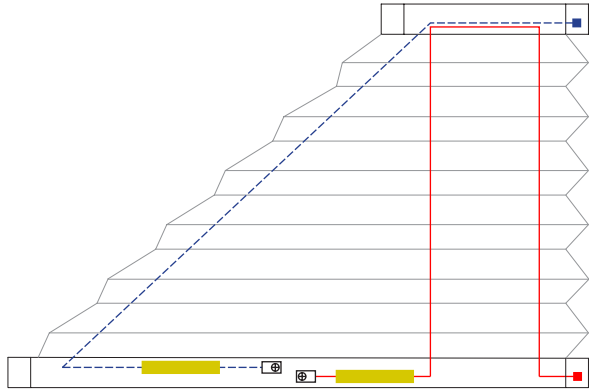

2 Schnurbohrungen/Cord boreholes/Passages de cordon

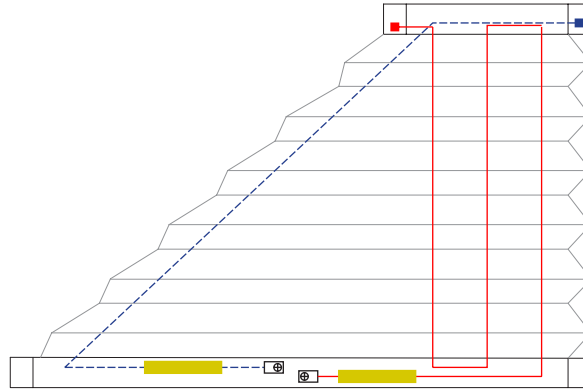

3 Schnurbohrungen/Cord boreholes/Passages de cordon

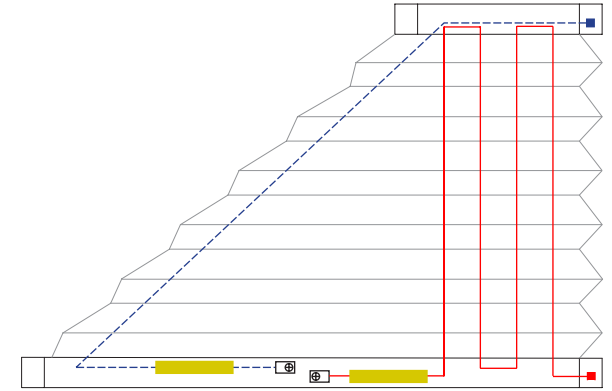

4 Schnurbohrungen/Cord boreholes/Passages de cordon

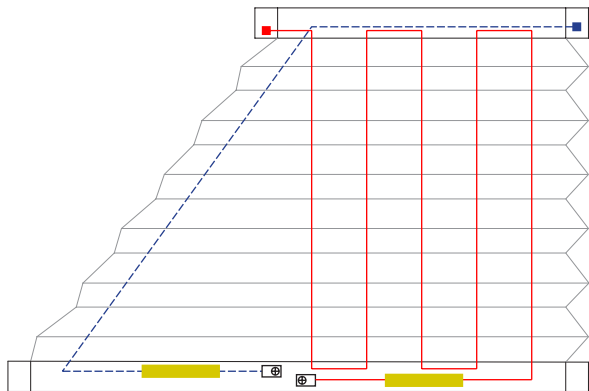

5 Schnurbohrungen/Cord boreholes/Passages de cordon

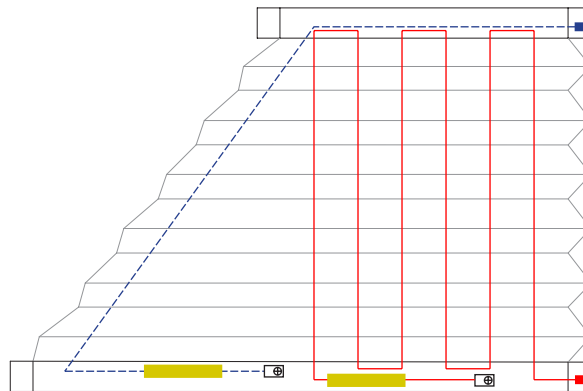

6

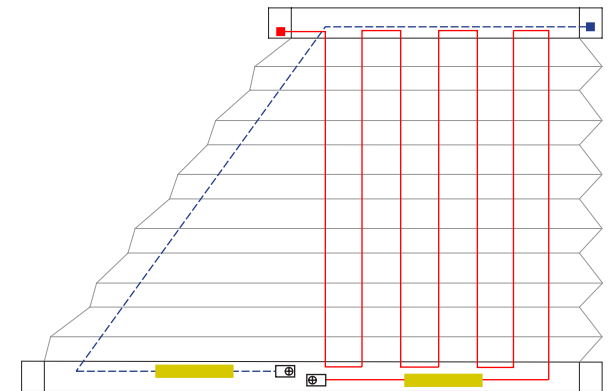

7 Schnurbohrungen/Cord boreholes/Passages de cordon



P 1037

- 1. Plisseeschnur/Pleating cord/Cordon à plisser Ø0,8 mm
- - - 2. Plisseeschnur/Pleating cord/Cordon à plisser Ø0,8 mm
- Zugfeder/Tension spring/Ressort de traction Ø0,7 x 44 mm
- Ⓢ Schnurspanner/Cord stretcher/Tendeur de cordon



2 Schnurbohrungen/Cord boreholes/Passages de cordon

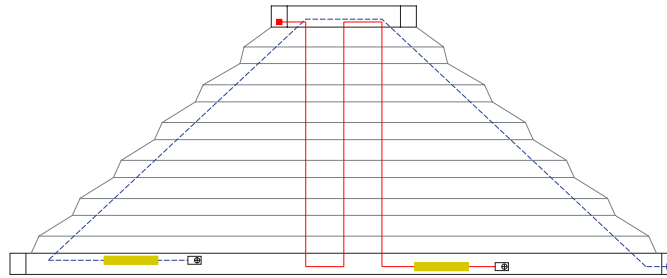

3 Schnurbohrungen/Cord boreholes/Passages de cordon

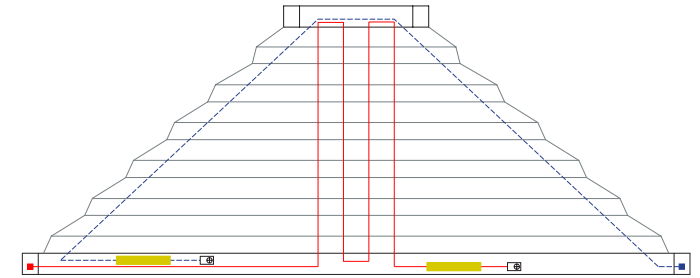

4 Schnurbohrungen/Cord boreholes/Passages de cordon

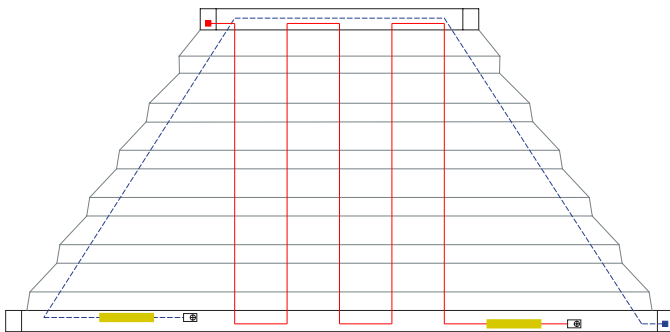

5 Schnurbohrungen/Cord boreholes/Passages de cordon

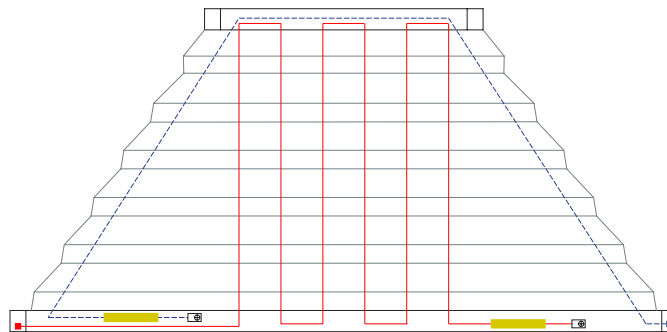

6 Schnurbohrungen/Cord boreholes/Passages de cordon

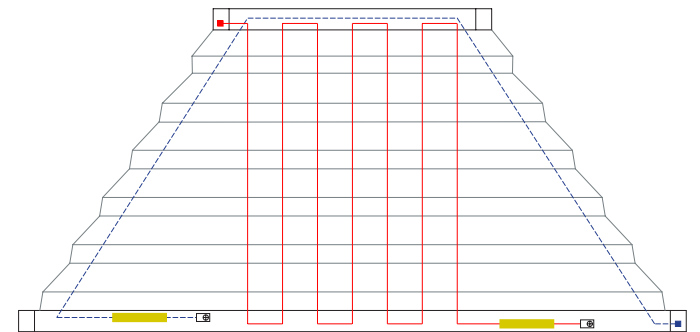

7 Schnurbohrungen/Cord boreholes/Passages de cordon

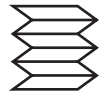

P 1083

- Drahtbügel/Wire arch/Arcaen
- Stoffniete/Fabric rivet/Rivet de tissu

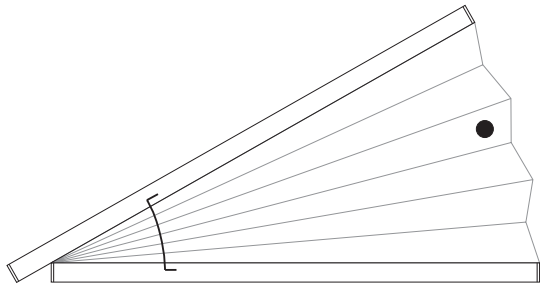

1 Stoffniete/Fabric rivet/Rivet de tissu

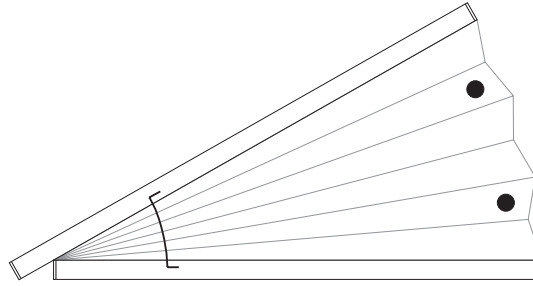

2 Stoffniete/Fabric rivet/Rivet de tissu

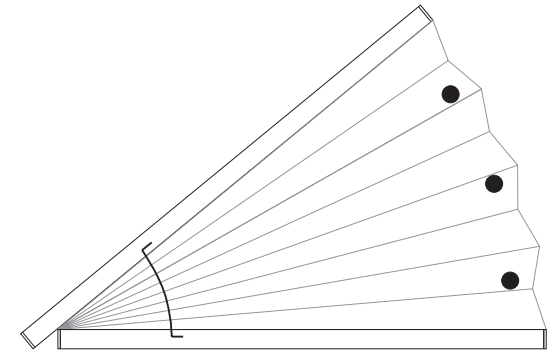

3 Stoffniete/Fabric rivet/Rivet de tissu

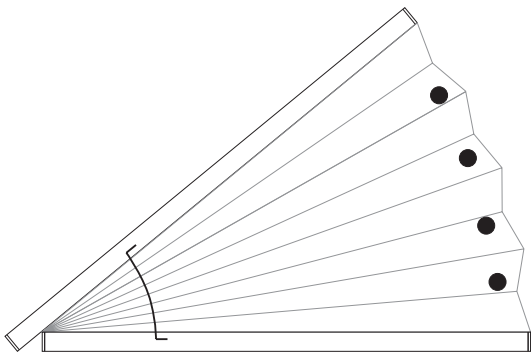

4 Stoffniete/Fabric rivet/Rivet de tissu



- 1. Plisseeschnur/Pleating cord/Cordon à plisser Ø0,8 mm
- - - 2. Plisseeschnur/Pleating cord/Cordon à plisser Ø0,8 mm
- - - 3. Plisseeschnur/Pleating cord/Cordon à plisser Ø0,8 mm

Federspanner/Spring winder/Tender de ressort

Zugfeder/Tension spring/Ressort de traction Ø0,7 x 44 mm

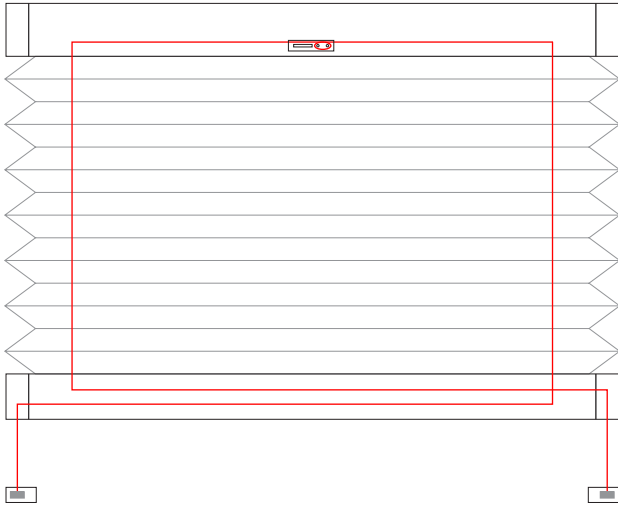

2 Schnurbohrungen/Cord boreholes/Passages de cordon
200-279 mm

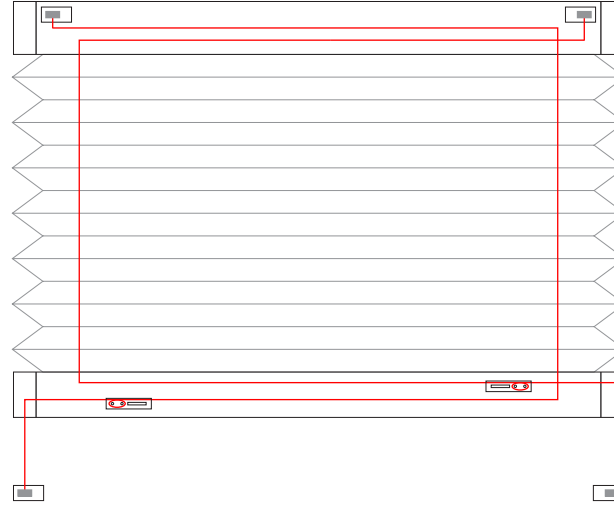

2 Schnurbohrungen/Cord boreholes/Passages de cordon
ab/starting from/à partir de 280 mm



3 Schnurbohrungen/Cord boreholes/Passages de cordon

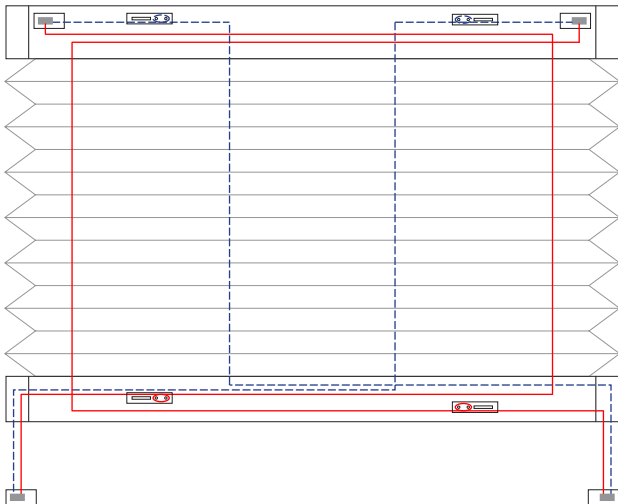

4 Schnurbohrungen/Cord boreholes/Passages de cordon

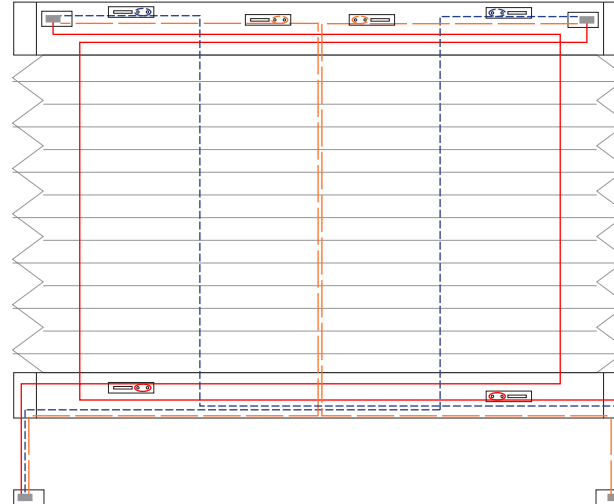

5 Schnurbohrungen/Cord boreholes/Passages de cordon

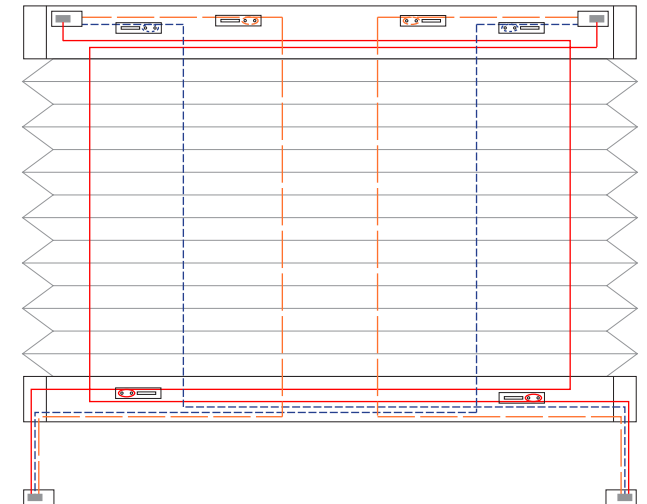

6 Schnurbohrungen/Cord boreholes/Passages de cordon



- 1. Plisseeschnur/Pleating cord/Cordon à plisser Ø0,8 mm
- 2. Plisseeschnur/Pleating cord/Cordon à plisser Ø0,8 mm
- 3. Plisseeschnur/Pleating cord/Cordon à plisser Ø0,8 mm

Federspanner/Spring winder/Tender de ressort

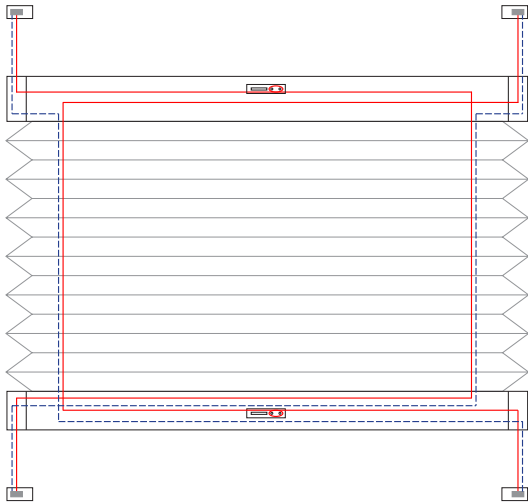

2 Schnurbohrungen/Cord boreholes/Passages de cordon
200-279 mm

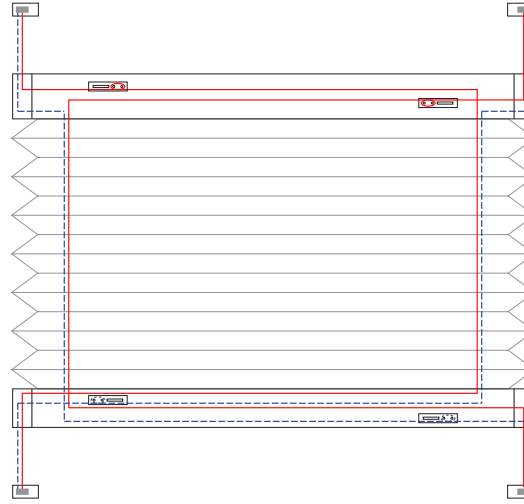

2 Schnurbohrungen/Cord boreholes/Passages de cordon
ab/starting from/à partir de 280 mm

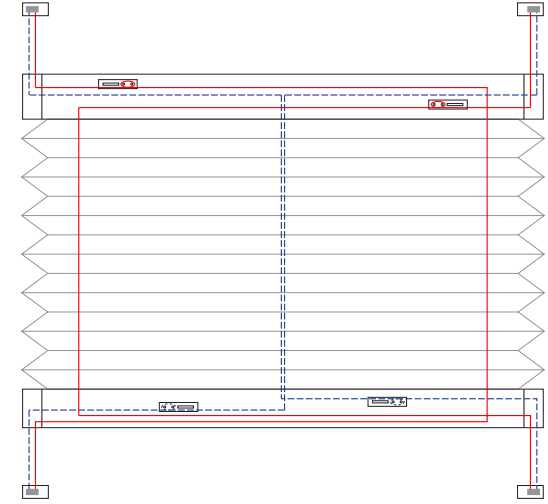

3 Schnurbohrungen/Cord boreholes/Passages de cordon

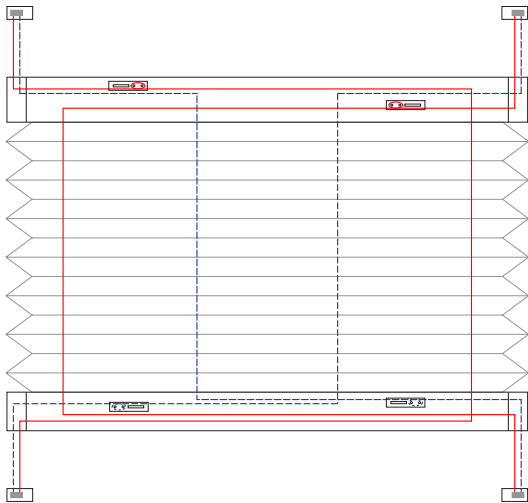

4 Schnurbohrungen/Cord boreholes/Passages de cordon

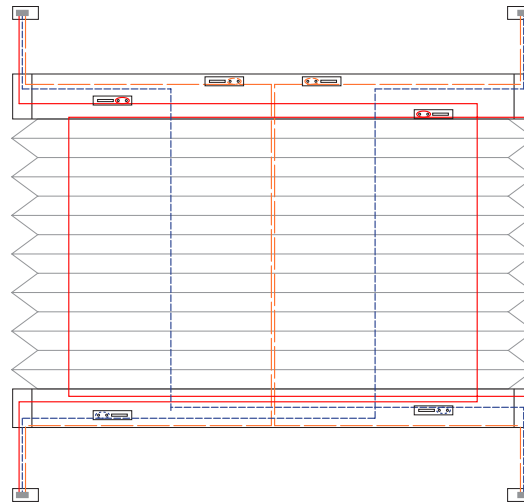

5 Schnurbohrungen/Cord boreholes/Passages de cordon

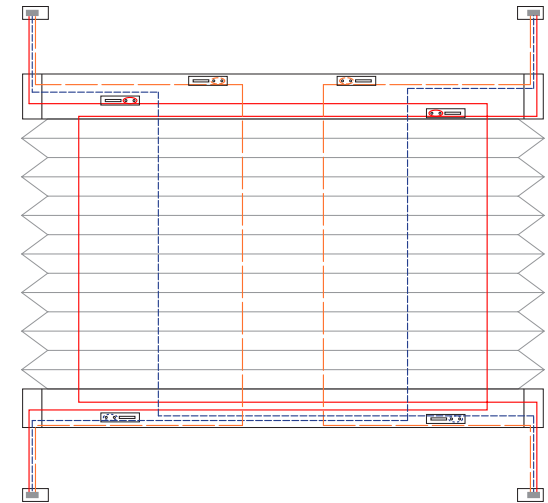

6 Schnurbohrungen/Cord boreholes/Passages de cordon



- 1. Plisseeschnur/Pleating cord/Cordon à plisser Ø0,8 mm
- - - 2. Plisseeschnur/Pleating cord/Cordon à plisser Ø0,8 mm
- 3. Plisseeschnur/Pleating cord/Cordon à plisser Ø0,8 mm

Federspanner/Spring winder/Tender de ressort

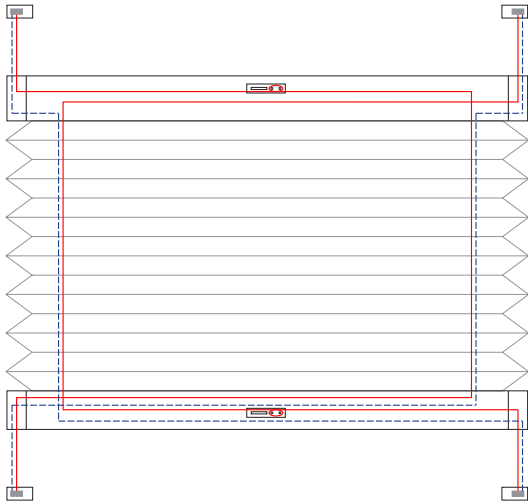

2 Schnurbohrungen/Cord boreholes/Passages de cordon
200-279 mm

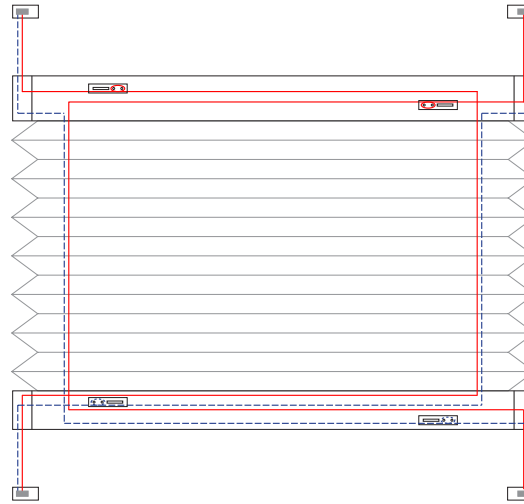

2 Schnurbohrungen/Cord boreholes/Passages de cordon
ab/starting from/à partir de 280 mm

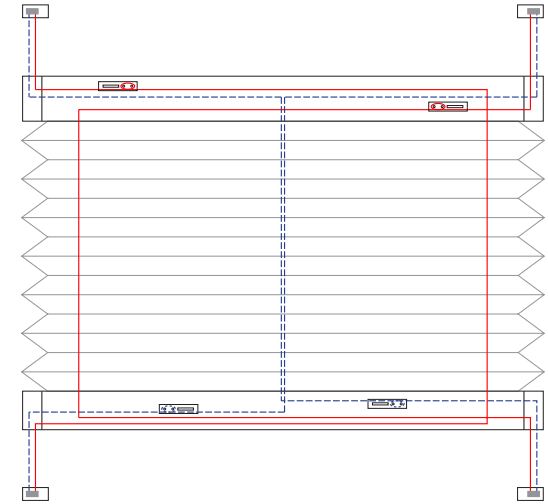

3 Schnurbohrungen/Cord boreholes/Passages de cordon

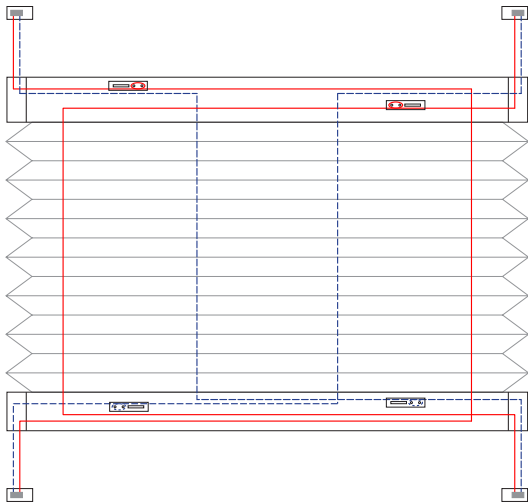

4 Schnurbohrungen/Cord boreholes/Passages de cordon

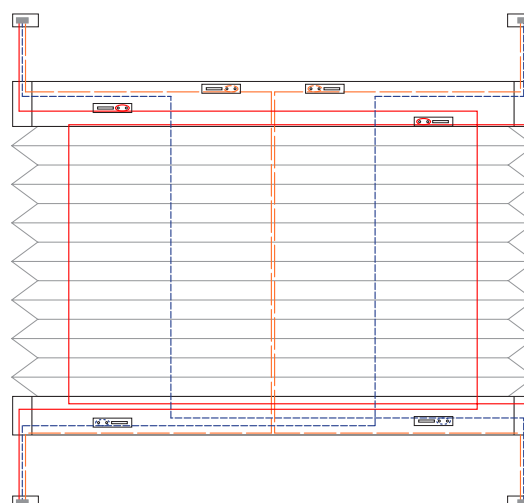

5 Schnurbohrungen/Cord boreholes/Passages de cordon

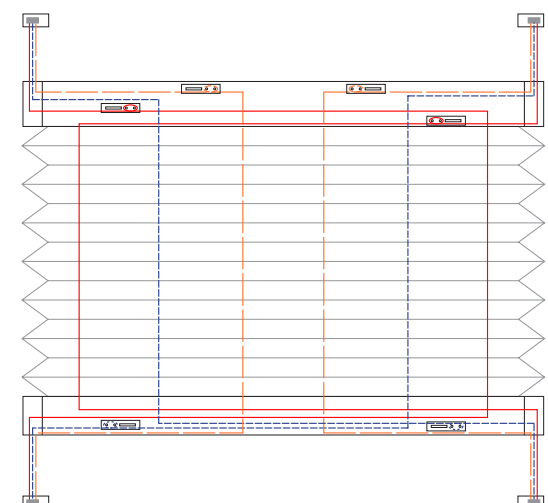

6 Schnurbohrungen/Cord boreholes/Passages de cordon



- 1. Plisseeschnur/Pleating cord/Cordon à plisser Ø0,8 mm
- - - 2. Plisseeschnur/Pleating cord/Cordon à plisser Ø0,8 mm
- 3. Plisseeschnur/Pleating cord/Cordon à plisser Ø0,8 mm

- Federspanner/Spring winder/Tender de ressort
- Zugfeder/Tension spring/Ressort de traction Ø0,7 x 44 mm

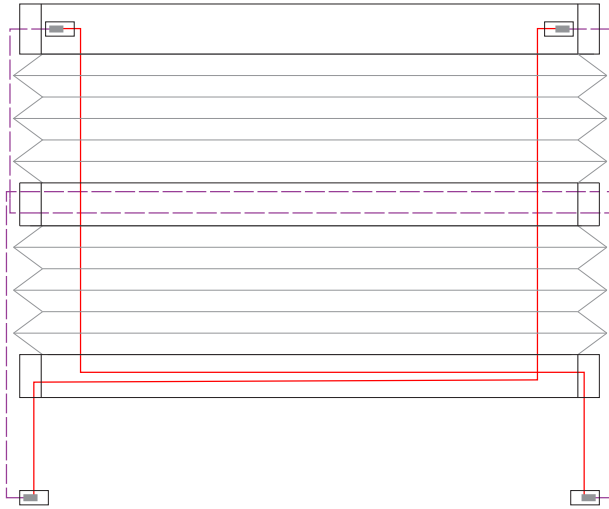

2 Schnurbohrungen/Cord boreholes/Passages de cordon
200-279 mm

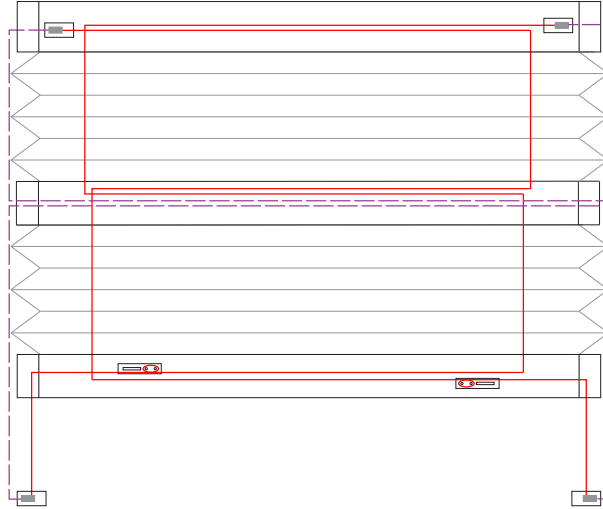

2 Schnurbohrungen/Cord boreholes/Passages de cordon
ab/starting from/à partir de 280 mm

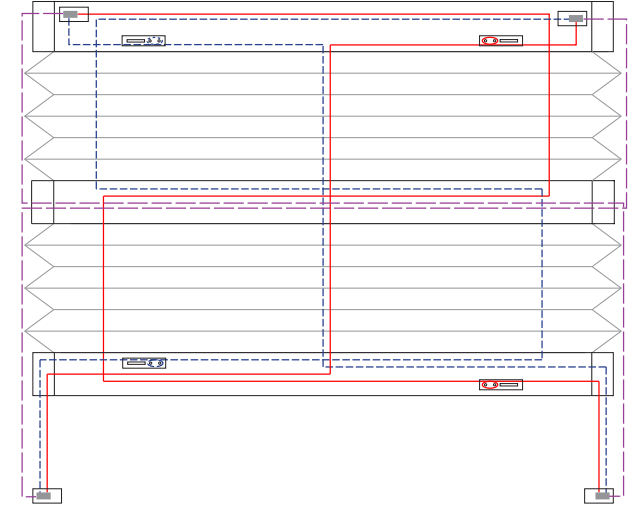

3 Schnurbohrungen/Cord boreholes/Passages de cordon

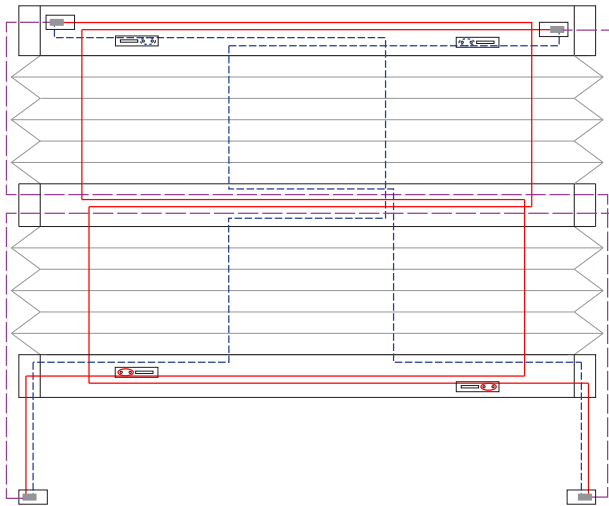

4 Schnurbohrungen/Cord boreholes/Passages de cordon

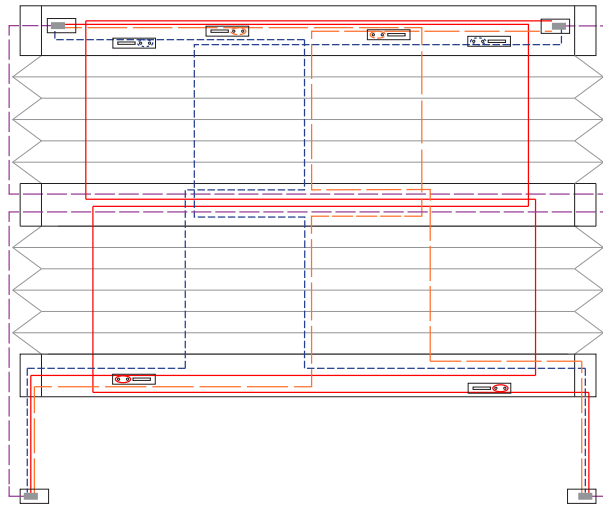

5 Schnurbohrungen/Cord boreholes/Passages de cordon

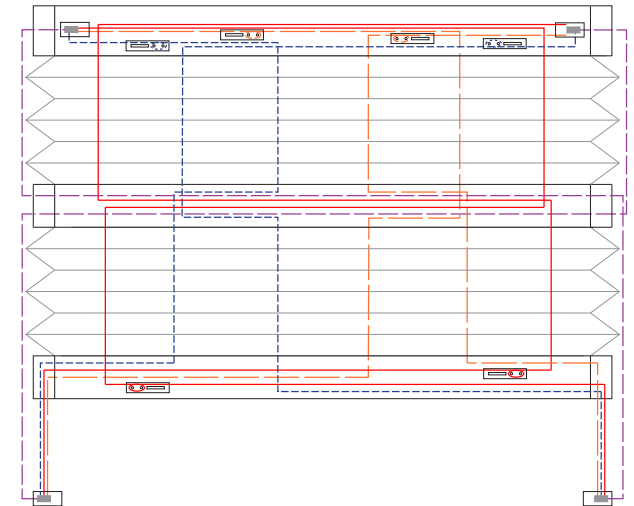

6 Schnurbohrungen/Cord boreholes/Passages de cordon



- 1. Plisseeschnur/Pleating cord/Cordon à plisser Ø0,8 mm
- - - 2. Plisseeschnur/Pleating cord/Cordon à plisser Ø0,8 mm
- - - 3. Plisseeschnur/Pleating cord/Cordon à plisser Ø0,8 mm

- Federspanner/Spring winder/Tender de ressort
- Zugfeder/Tension spring/Ressort de traction Ø0,7 x 44 mm

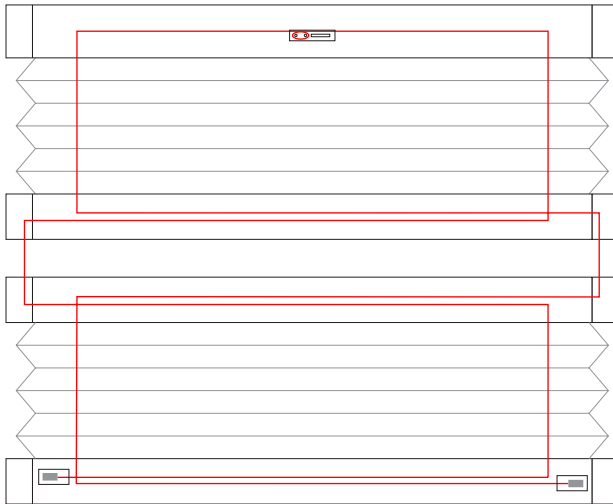

2 Schnurbohrungen/Cord boreholes/Passages de cordon
200-279 mm

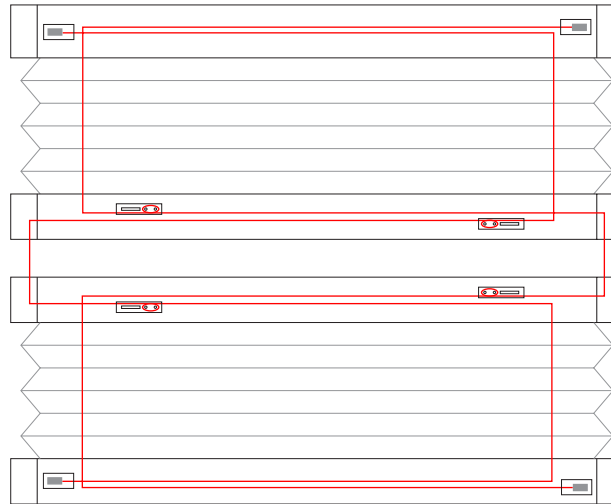

2 Schnurbohrungen/Cord boreholes/Passages de cordon
ab/starting from/à partir de 280 mm



3 Schnurbohrungen/Cord boreholes/Passages de cordon

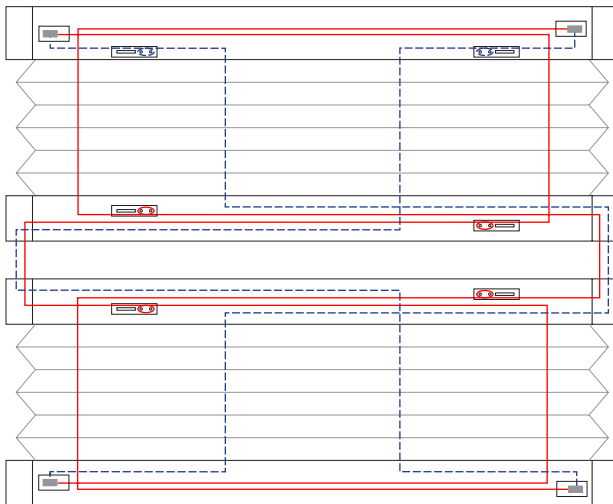

4 Schnurbohrungen/Cord boreholes/Passages de cordon



5 Schnurbohrungen/Cord boreholes/Passages de cordon

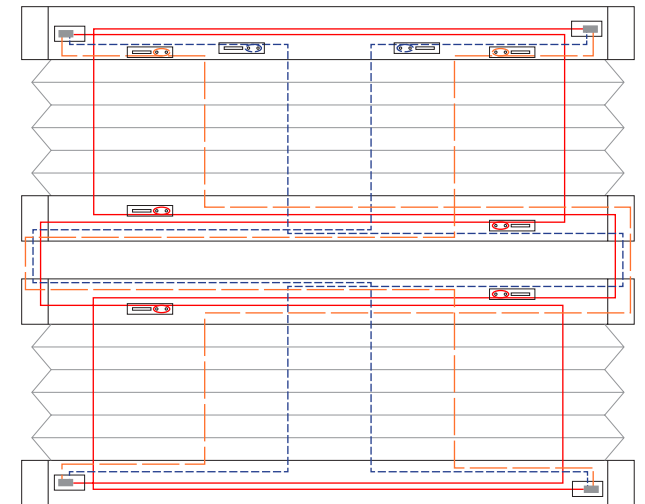

6 Schnurbohrungen/Cord boreholes/Passages de cordon



P 2602

- 1. Plisseeschnur/Pleating cord/Cordon à plisser Ø0,8 mm
- 2. Plisseeschnur/Pleating cord/Cordon à plisser Ø0,8 mm
- 3. Plisseeschnur/Pleating cord/Cordon à plisser Ø0,8 mm
- Spannschnur/Tension cord/Cordon de tension Ø1,2 mm

Federspanner/Spring winder/Tender de ressort

Zugfeder/Tension spring/Ressort de traction Ø0,7 x 44 mm

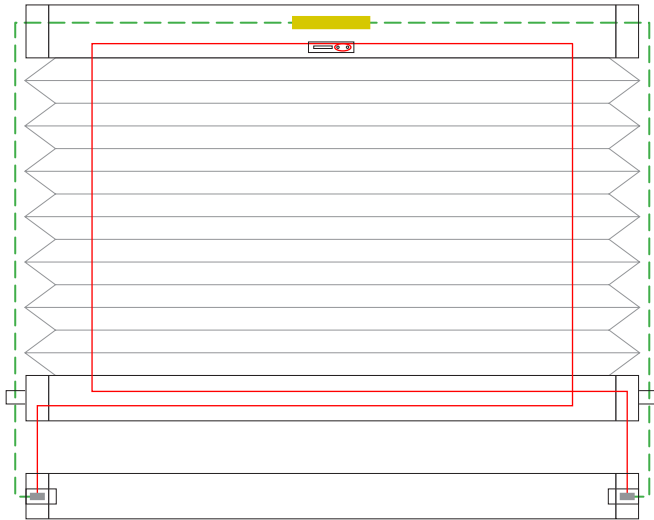

2 Schnurbohrungen/Cord boreholes/Passages de cordon
200-279 mm

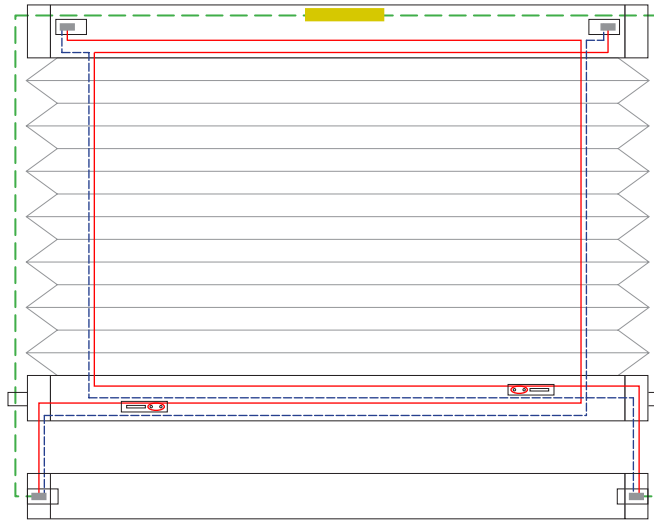

2 Schnurbohrungen/Cord boreholes/Passages de cordon
ab/starting from/à partir de 280 mm

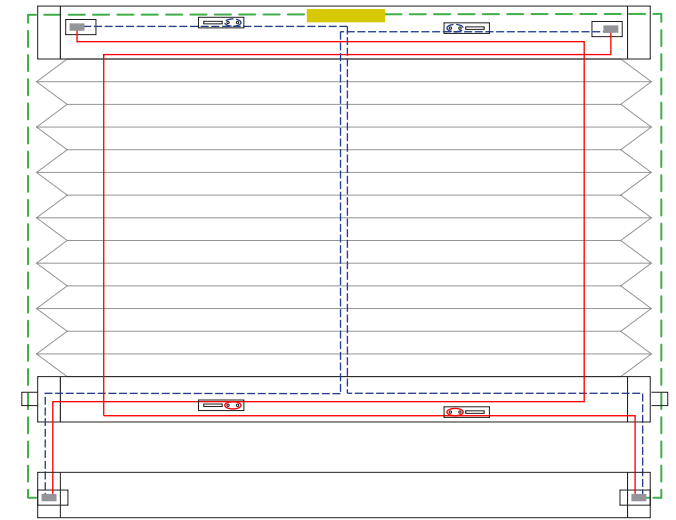

3 Schnurbohrungen/Cord boreholes/Passages de cordon

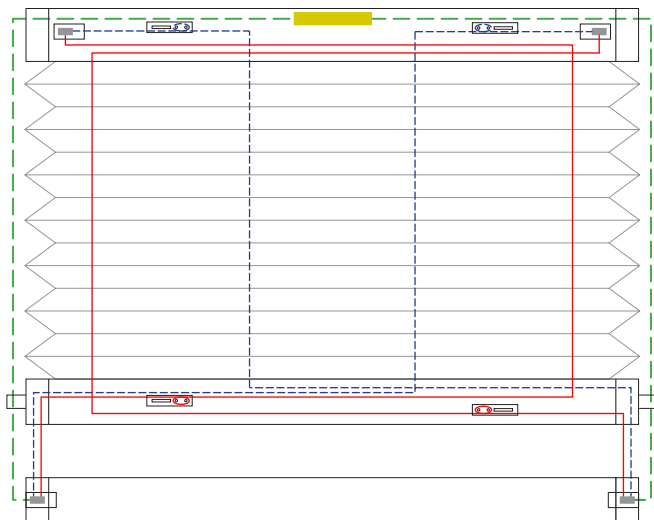

4 Schnurbohrungen/Cord boreholes/Passages de cordon

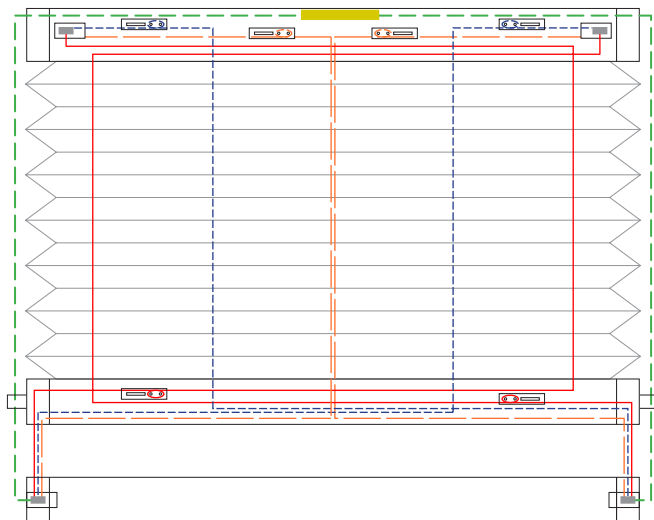

5 Schnurbohrungen/Cord boreholes/Passages de cordon

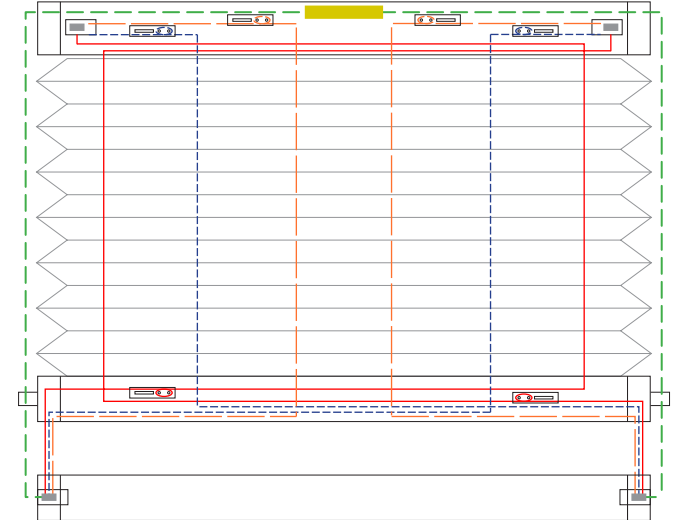

6 Schnurbohrungen/Cord boreholes/Passages de cordon



P 2610

- 1. Plisseeschnur/Pleating cord/Cordon à plisser Ø0,8 mm
- - - 2. Plisseeschnur/Pleating cord/Cordon à plisser Ø0,8 mm
- 3. Plisseeschnur/Pleating cord/Cordon à plisser Ø0,8 mm
- - - Spannschnur/Tension cord/Cordon de tension Ø1,2 mm

Federspanner/Spring winder/Tender de ressort

Zugfeder/Tension spring/Ressort de traction Ø0,7 x 44 mm

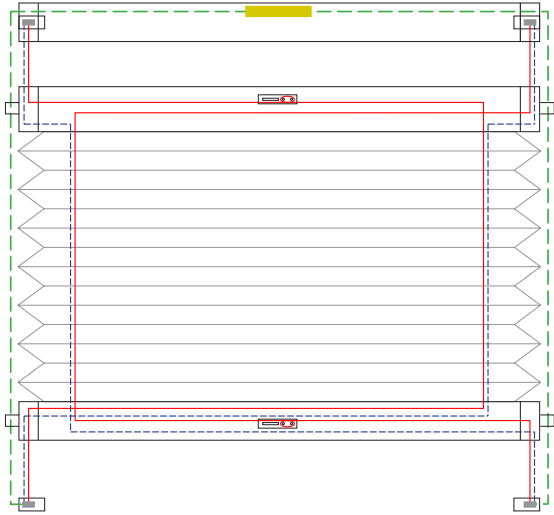

2 Schnurbohrungen/Cord boreholes/Passages de cordon
200-279 mm

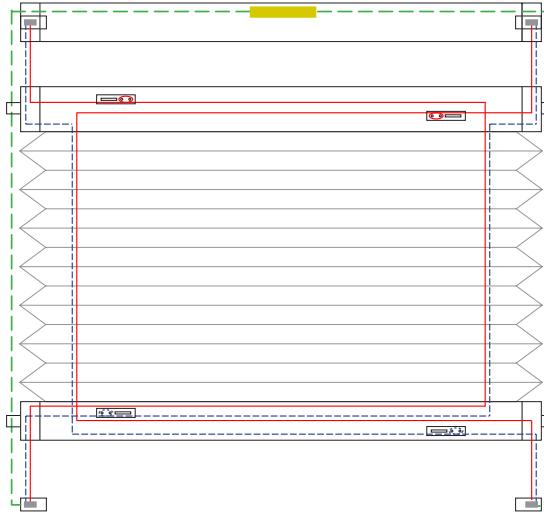

2 Schnurbohrungen/Cord boreholes/Passages de cordon
ab/starting from/à partir de 280 mm

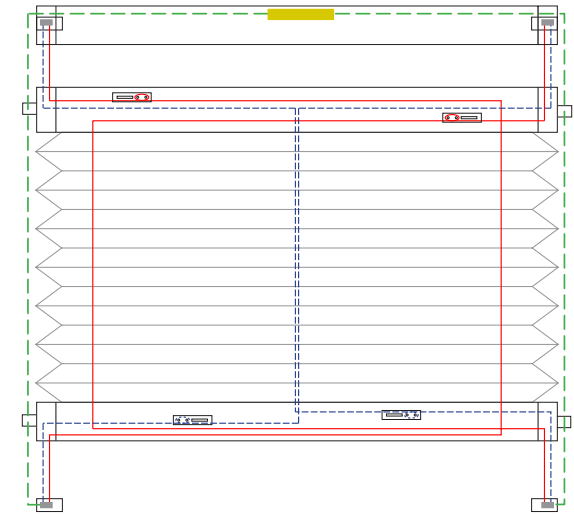

3 Schnurbohrungen/Cord boreholes/Passages de cordon

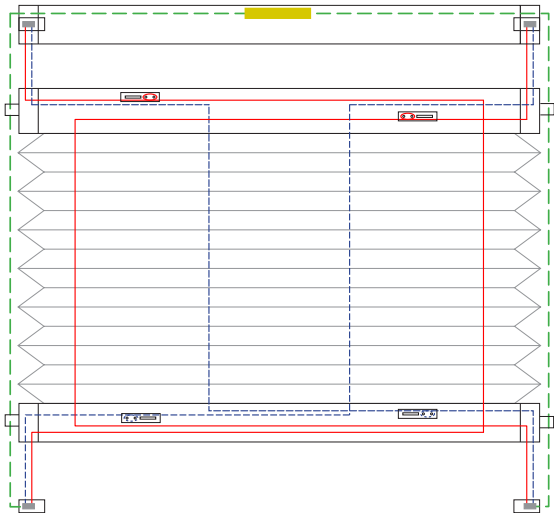

4 Schnurbohrungen/Cord boreholes/Passages de cordon

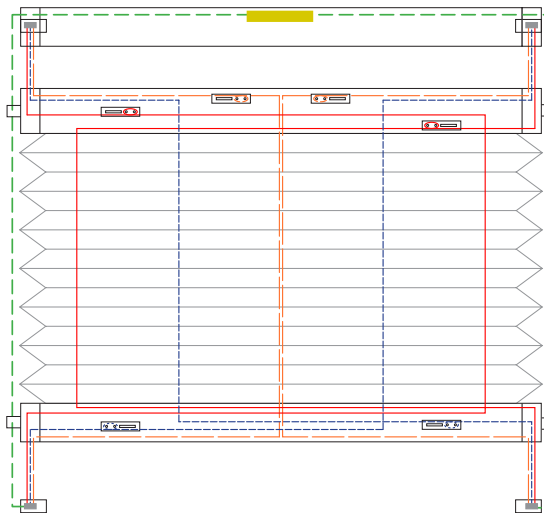

5 Schnurbohrungen/Cord boreholes/Passages de cordon

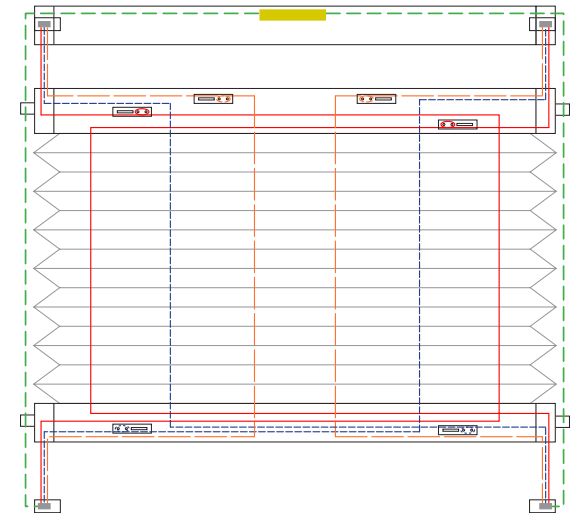

6 Schnurbohrungen/Cord boreholes/Passages de cordon



- 1. Plisseeschnur/Pleating cord/Cordon à plisser Ø0,8 mm
- - - 2. Plisseeschnur/Pleating cord/Cordon à plisser Ø0,8 mm
- 3. Plisseeschnur/Pleating cord/Cordon à plisser Ø0,8 mm
- - - Spannschnur/Tension cord/Cordon de tension Ø1,2 mm

- Federspanner/Spring winder/Tender de ressort
- Zugfeder/Tension spring/Ressort de traction Ø0,7 x 44 mm

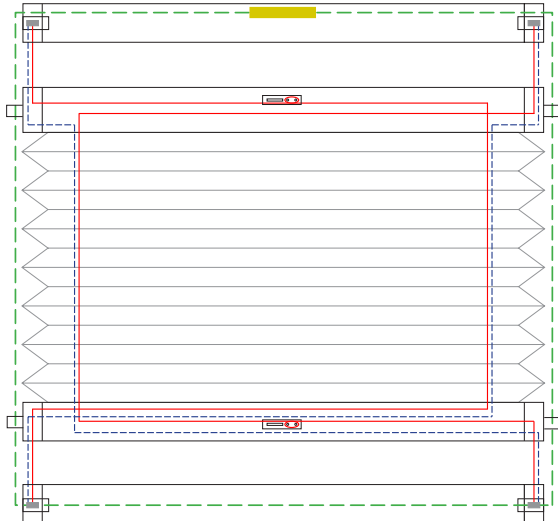

2 Schnurbohrungen/Cord boreholes/Passages de cordon
200-279 mm

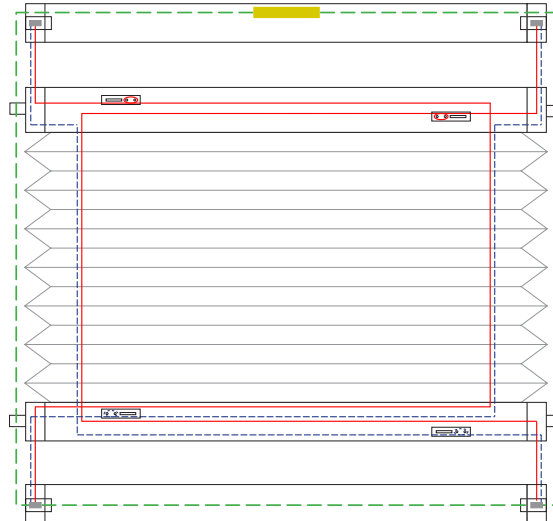

2 Schnurbohrungen/Cord boreholes/Passages de cordon
ab/starting from/à partir de 280 mm

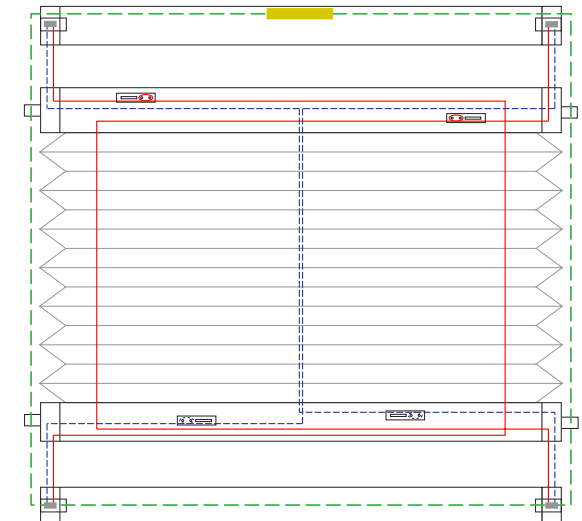

3 Schnurbohrungen/Cord boreholes/Passages de cordon

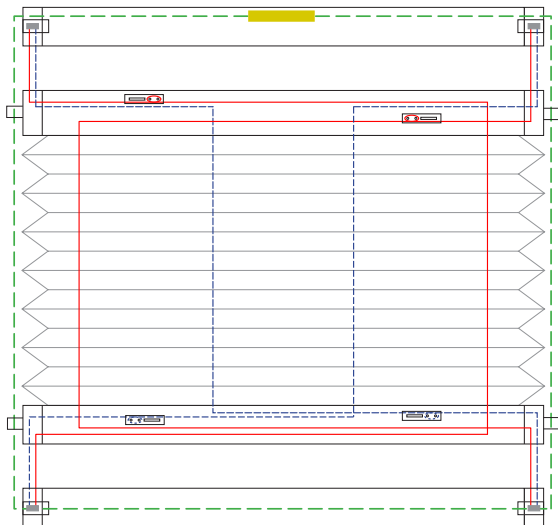

4 Schnurbohrungen/Cord boreholes/Passages de cordon

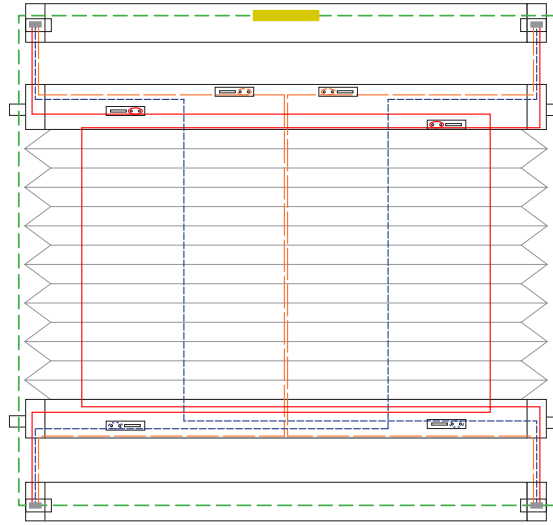

5 Schnurbohrungen/Cord boreholes/Passages de cordon

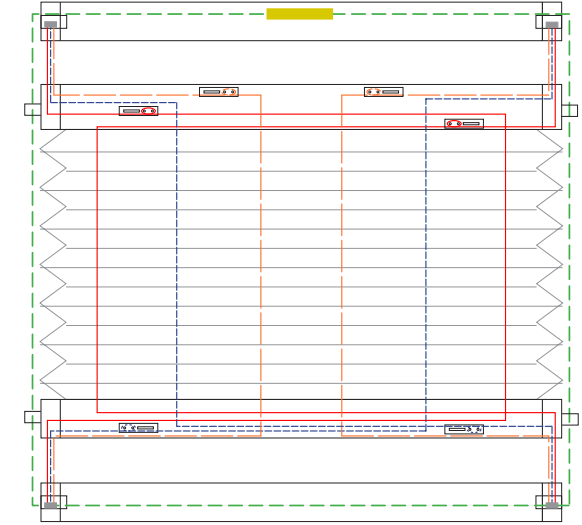

6 Schnurbohrungen/Cord boreholes/Passages de cordon



- 1. Plisseeschnur/Pleating cord/Cordon à plisser Ø0,8 mm
- 2. Plisseeschnur/Pleating cord/Cordon à plisser Ø0,8 mm
- 3. Plisseeschnur/Pleating cord/Cordon à plisser Ø0,8 mm
- Spannschnur/Tension cord/Cordon de tension Ø1,2 mm

Federspanner/Spring winder/Tender de ressort

Zugfeder/Tension spring/Ressort de traction Ø0,7 x 44 mm

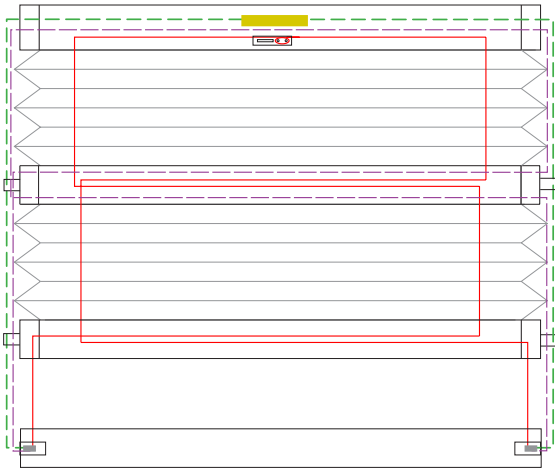

2 Schnurbohrungen/Cord boreholes/Passages de cordon
200-279 mm

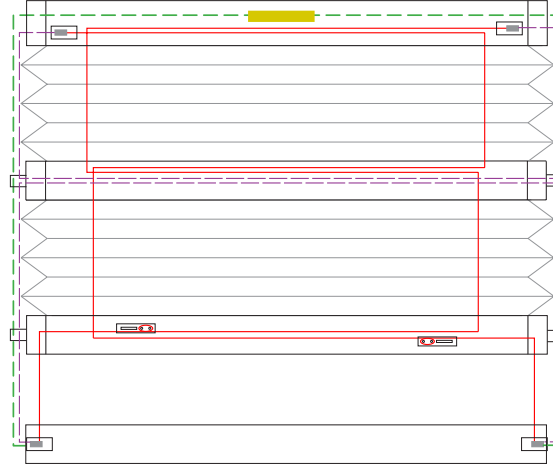

2 Schnurbohrungen/Cord boreholes/Passages de cordon
ab/starting from/à partir de 280 mm

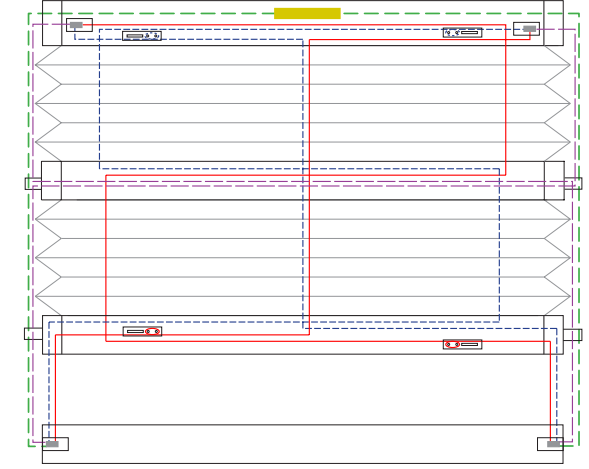

3 Schnurbohrungen/Cord boreholes/Passages de cordon

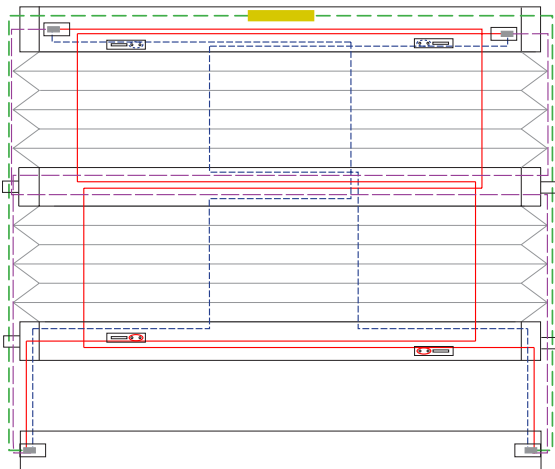

4 Schnurbohrungen/Cord boreholes/Passages de cordon

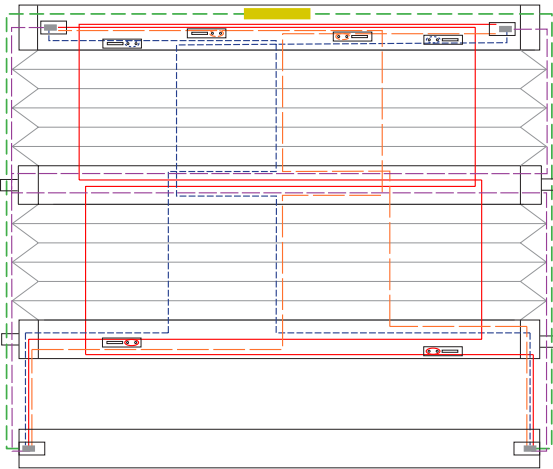



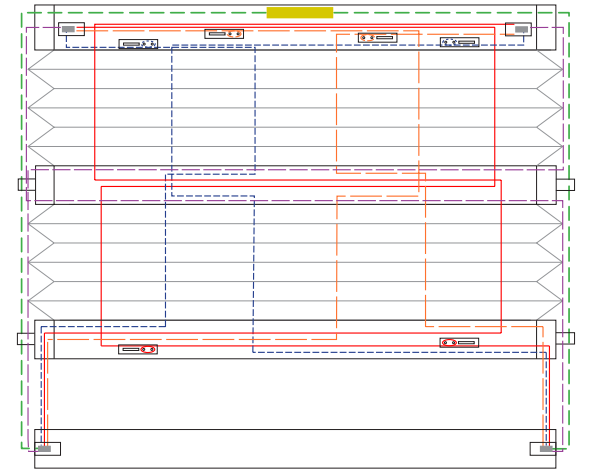

5 Schnurbohrungen/Cord boreholes/Passages de cordon



6 Schnurbohrungen/Cord boreholes/Passages de cordon



P 2626

-  1. Plisseeschnur/Pleating cord/Cordon à plisser Ø0,8 mm
-  2. Plisseeschnur/Pleating cord/Cordon à plisser Ø0,8 mm
-  3. Plisseeschnur/Pleating cord/Cordon à plisser Ø0,8 mm
-  Spannschnur/Tension cord/Cordon de tension Ø1,2 mm

 Federspanner/Spring winder/Tender de ressort

 Zugfeder/Tension spring/Ressort de traction Ø0,7 x 44 mm



2 Schnurbohrungen/Cord boreholes/Passages de cordon
200-279 mm

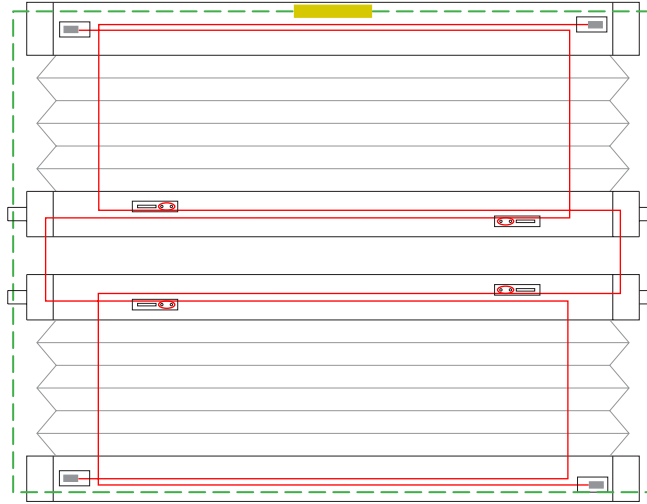

2 Schnurbohrungen/Cord boreholes/Passages de cordon
ab/starting from/à partir 280 mm

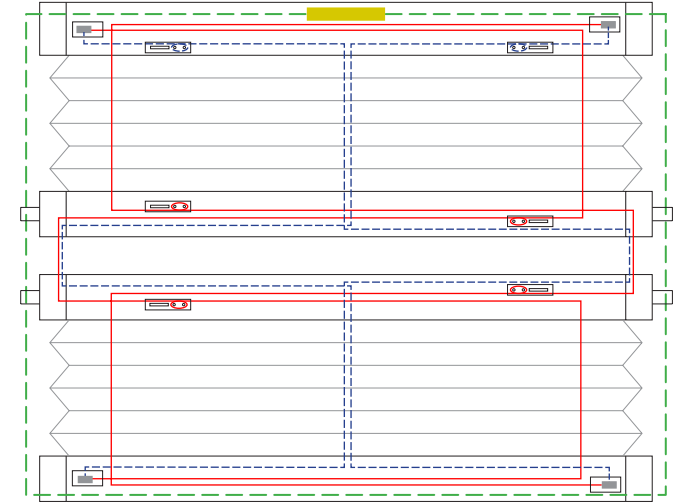

3 Schnurbohrungen/Cord boreholes/Passages de cordon

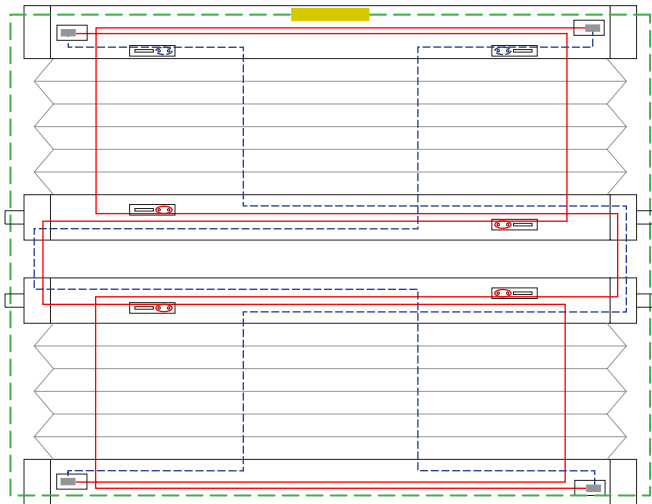

4 Schnurbohrungen/Cord boreholes/Passages de cordon







5 Schnurbohrungen/Cord boreholes/Passages de cordon



6 Schnurbohrungen/Cord boreholes/Passages de cordon



P 3630-1

-  Plisseeschnur/Pleating cord/Cordon à plisser Ø0,8 mm
-  Spanndraht/Tension wire/Fil de tension Ø0,8 mm
-  Zugfeder/Tension spring/Ressort de traction Ø0,7 x 44 mm
-  Drahtspanner/Wire stretcher/Tendeur de fil

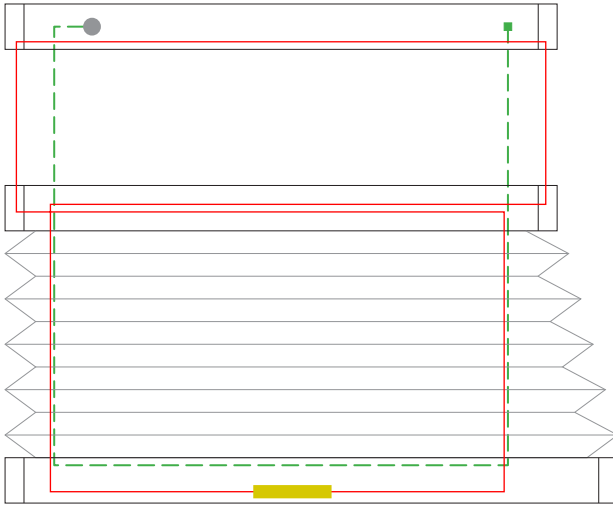

2 Drahtbohrungen/Wire boreholes/Passages de fil

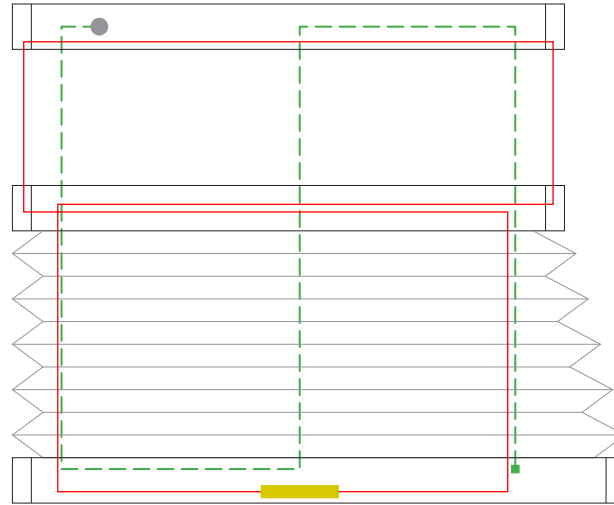

3 Drahtbohrungen/Wire boreholes/Passages de fil

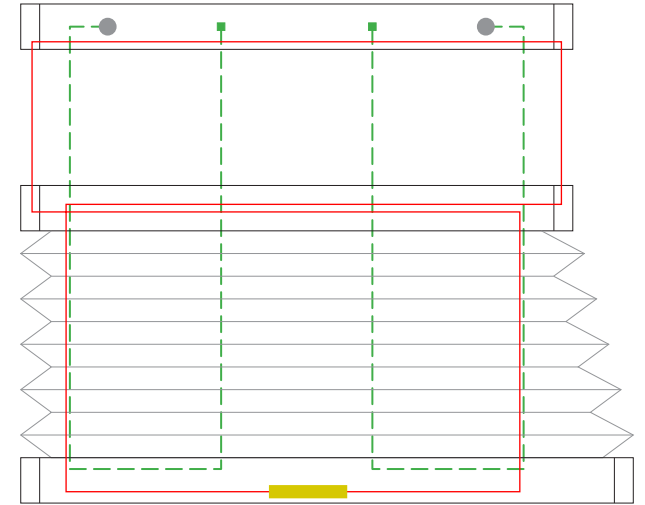

4 Drahtbohrungen/Wire boreholes/Passages de fil

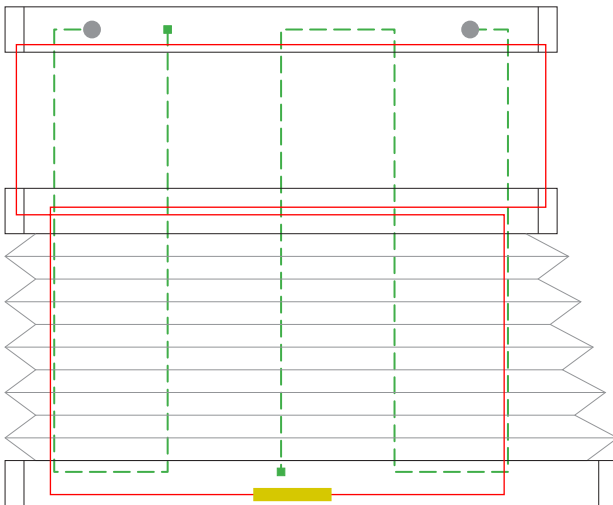

5 Drahtbohrungen/Wire boreholes/Passages de fil

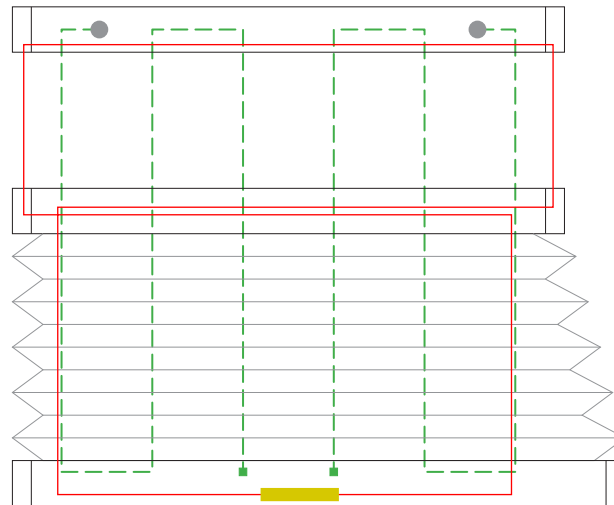

6 Drahtbohrungen/Wire boreholes/Passages de fil

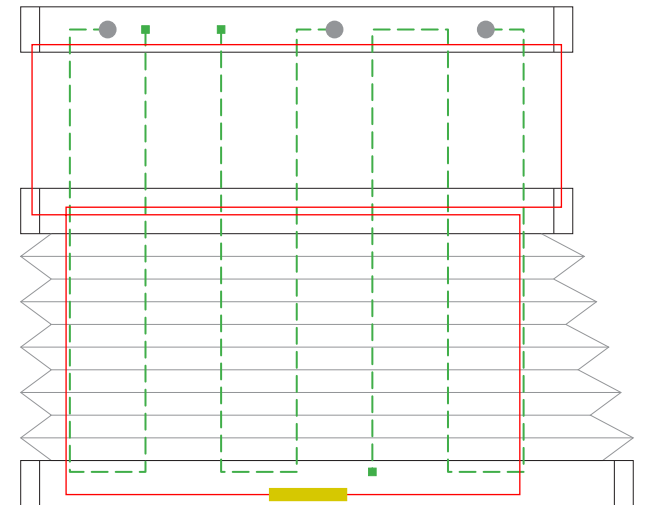

7 Drahtbohrungen/Wire boreholes/Passages de fil



P 3630-2

- Plisseeschnur/Pleating cord/Cordon à plisser Ø0,8 mm
- - - Spanndraht/Tension wire/Fil de tension Ø0,8 mm
- Zugfeder/Tension spring/Ressort de traction Ø0,7 x 44 mm
- Drahtspanner/Wire stretcher/Tendeur de fil

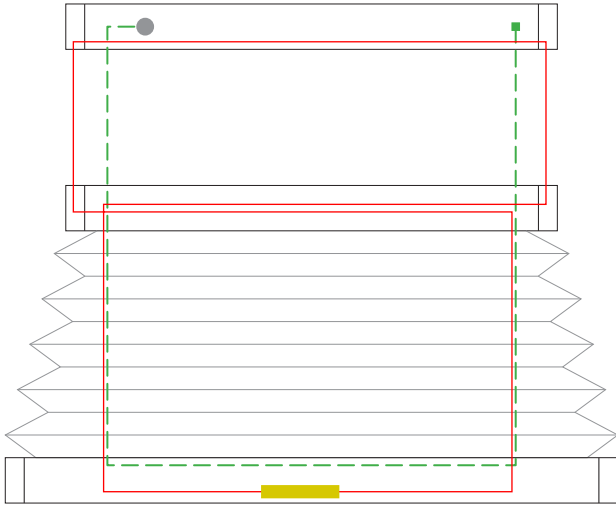

2 Drahtbohrungen/Wire boreholes/Passages de fil

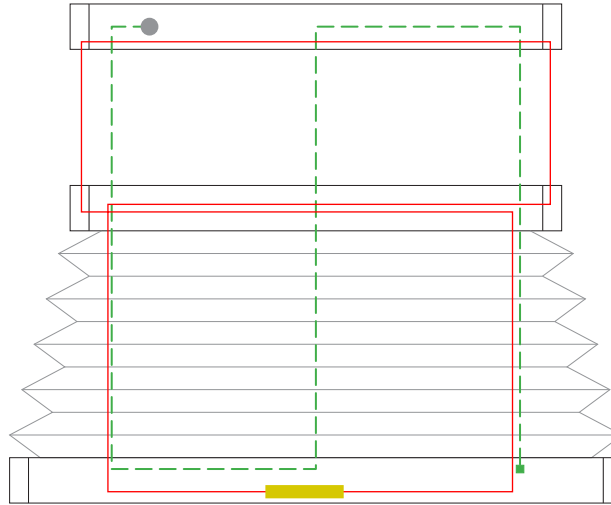

3 Drahtbohrungen/Wire boreholes/Passages de fil

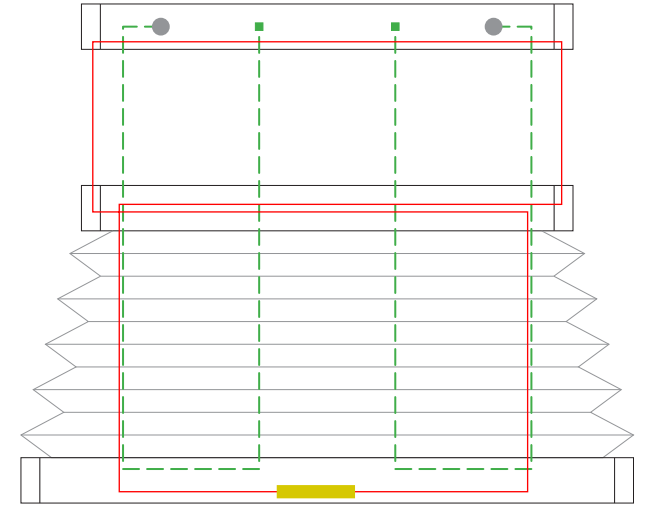

4 Drahtbohrungen/Wire boreholes/Passages de fil

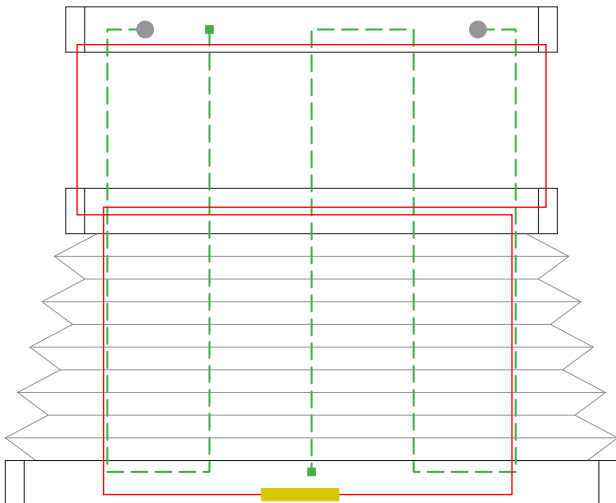

5 Drahtbohrungen/Wire boreholes/Passages de fil

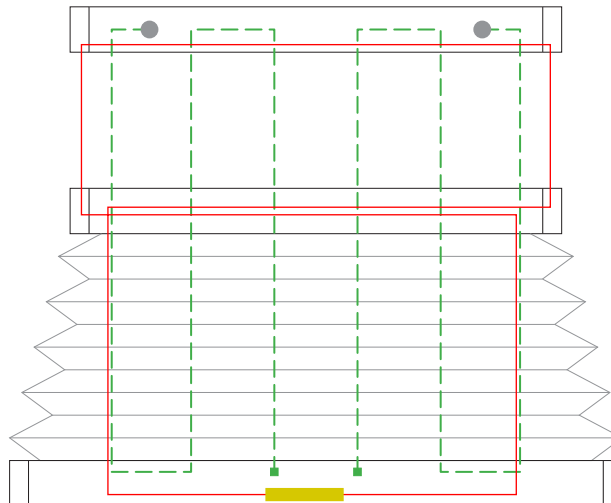

6 Drahtbohrungen/Wire boreholes/Passages de fil

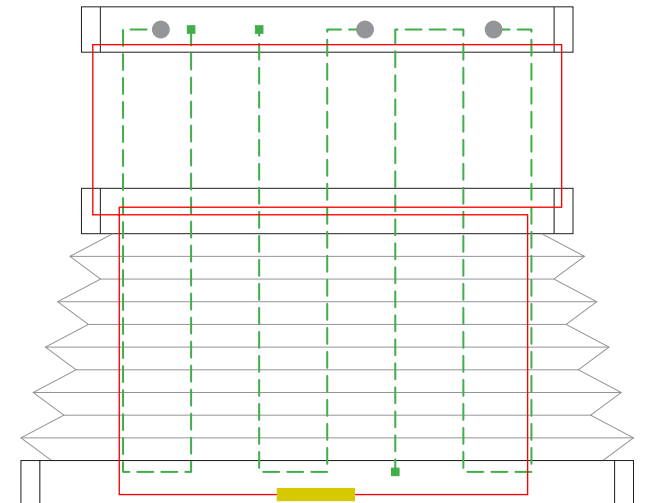

7 Drahtbohrungen/Wire boreholes/Passages de fil



P 3630-3

- Plisseeschnur/Pleating cord/Cordon à plisser Ø0,8 mm
- - - Gummiband/Rubber band/Ruban en caoutchouc Ø1,25 mm
- - - Spanndraht/Tension wire/Fil de tension Ø0,8 mm
- Zugfeder/Tension spring/Ressort de traction Ø0,7 x 44 mm

- Drahtspanner/Wire stretcher/Tendeur de fil

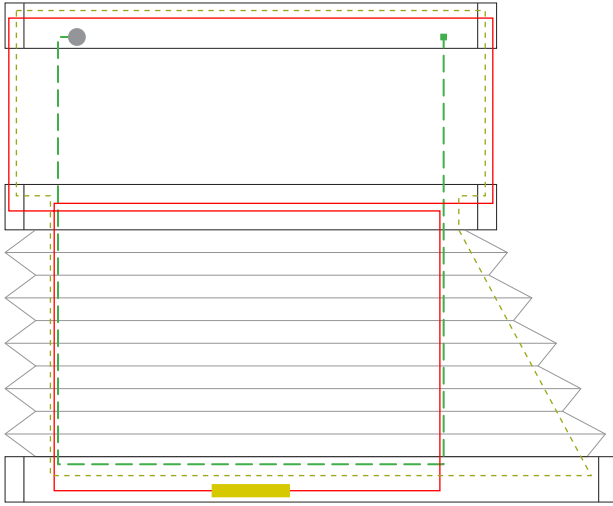

2 Drahtbohrungen/Wire boreholes/Passages de fil

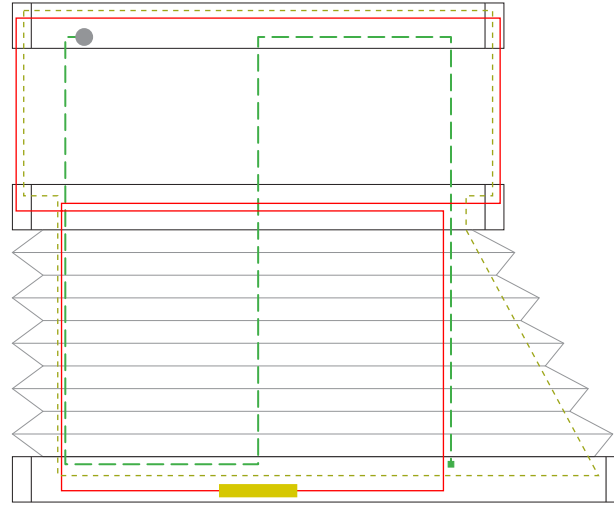

3 Drahtbohrungen/Wire boreholes/Passages de fil

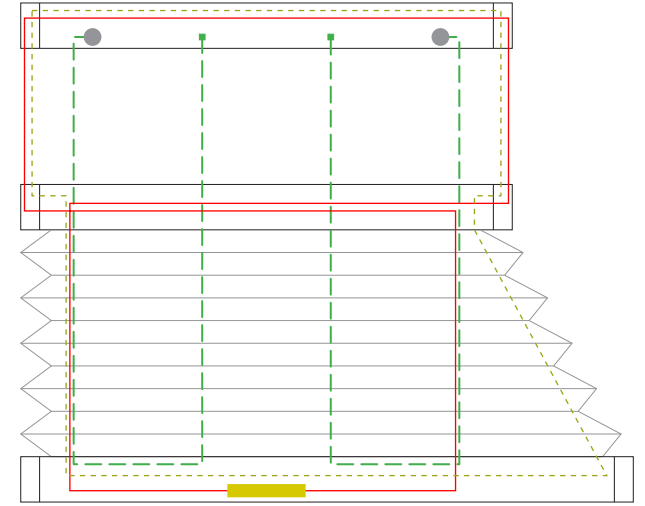

4 Drahtbohrungen/Wire boreholes/Passages de fil

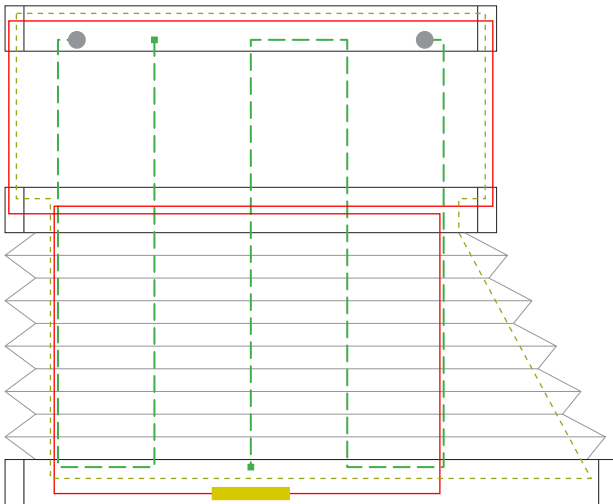

5 Drahtbohrungen/Wire boreholes/Passages de fil

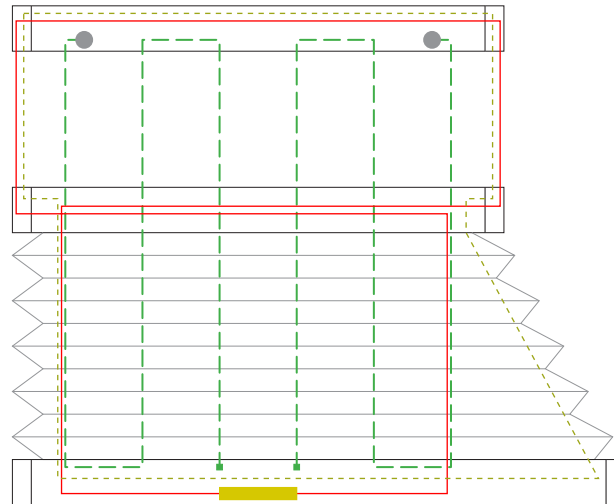

6 Drahtbohrungen/Wire boreholes/Passages de fil

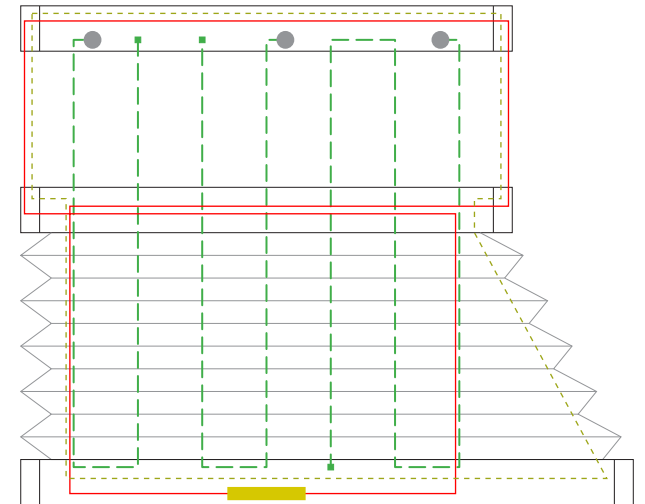

7 Drahtbohrungen/Wire boreholes/Passages de fil



P 3630-4

- Plisseeschnur/Pleating cord/Cordon à plisser Ø0,8 mm
- - - Gummiband/Rubber band/Ruban en caoutchouc Ø1,25 mm
- - - Spanndraht/Tension wire/Fil de tension Ø0,8 mm
- Zugfeder/Tension spring/Ressort de traction Ø0,7 x 44 mm

- Drahtspanner/Wire stretcher/Tendeur de fil

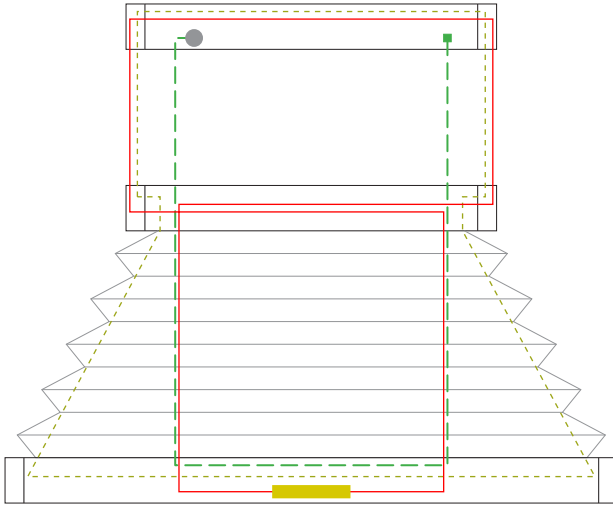

2 Drahtbohrungen/Wire boreholes/Passages de fil

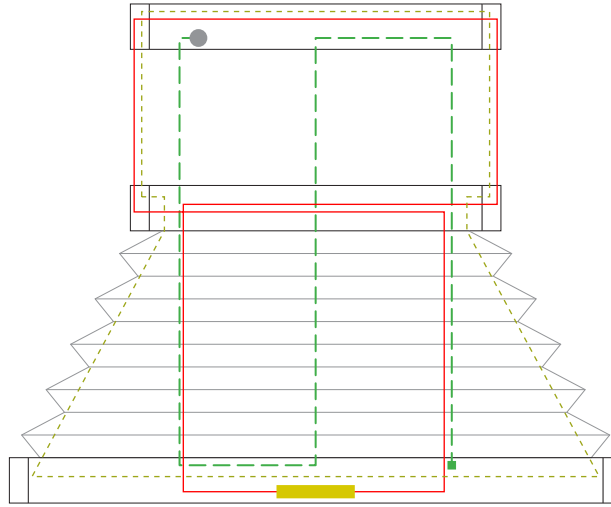

3 Drahtbohrungen/Wire boreholes/Passages de fil

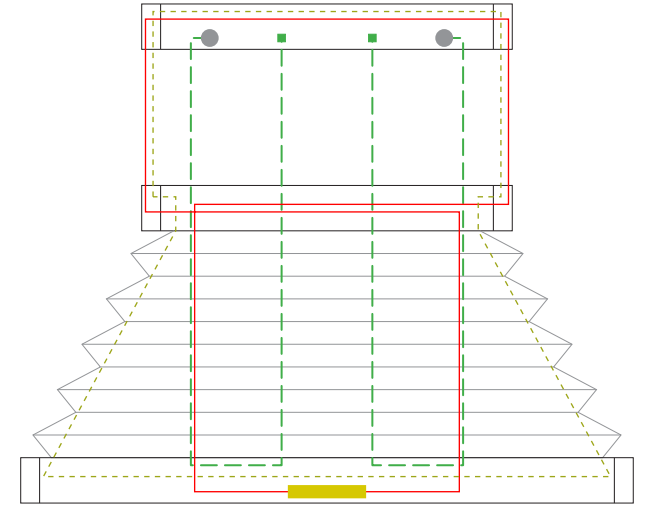

4 Drahtbohrungen/Wire boreholes/Passages de fil

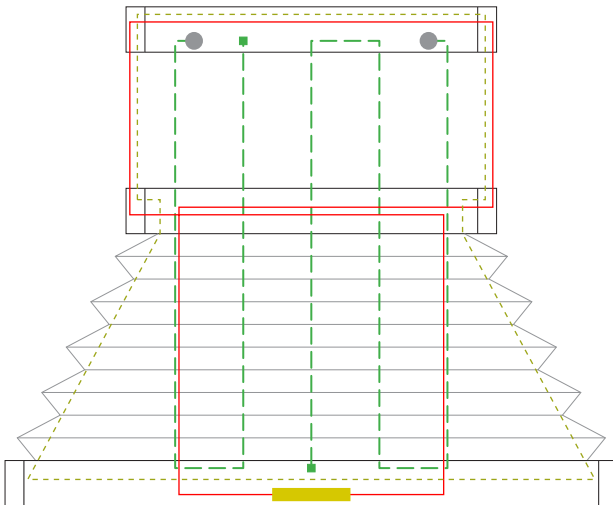

5 Drahtbohrungen/Wire boreholes/Passages de fil

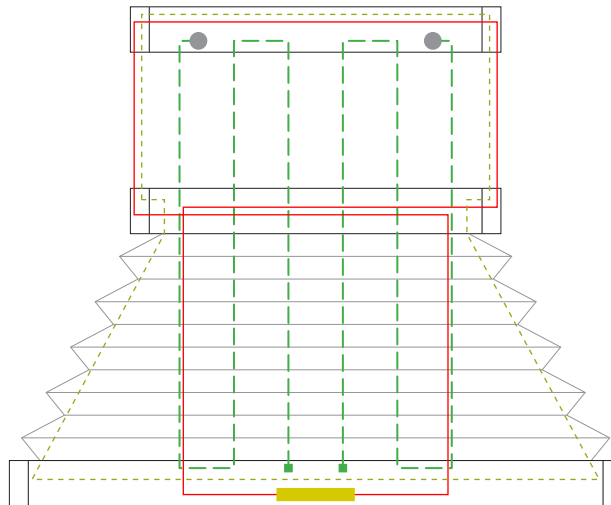



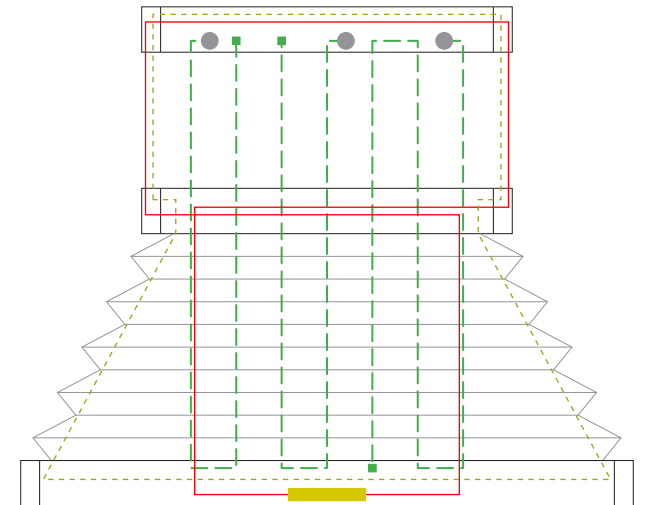

6 Drahtbohrungen/Wire boreholes/Passages de fil





7 Drahtbohrungen/Wire boreholes/Passages de fil



P 3660-2

-  1. Plisseeschnur/Pleating cord/Cordon à plisser Ø0,8 mm
-  2. Plisseeschnur/Pleating cord/Cordon à plisser Ø0,8 mm
-  Spanndraht/Tension wire/Fil de tension Ø0,8 mm
-  Stoppschnur/Stop cord/Cordon d'arrêt Ø0,8 mm



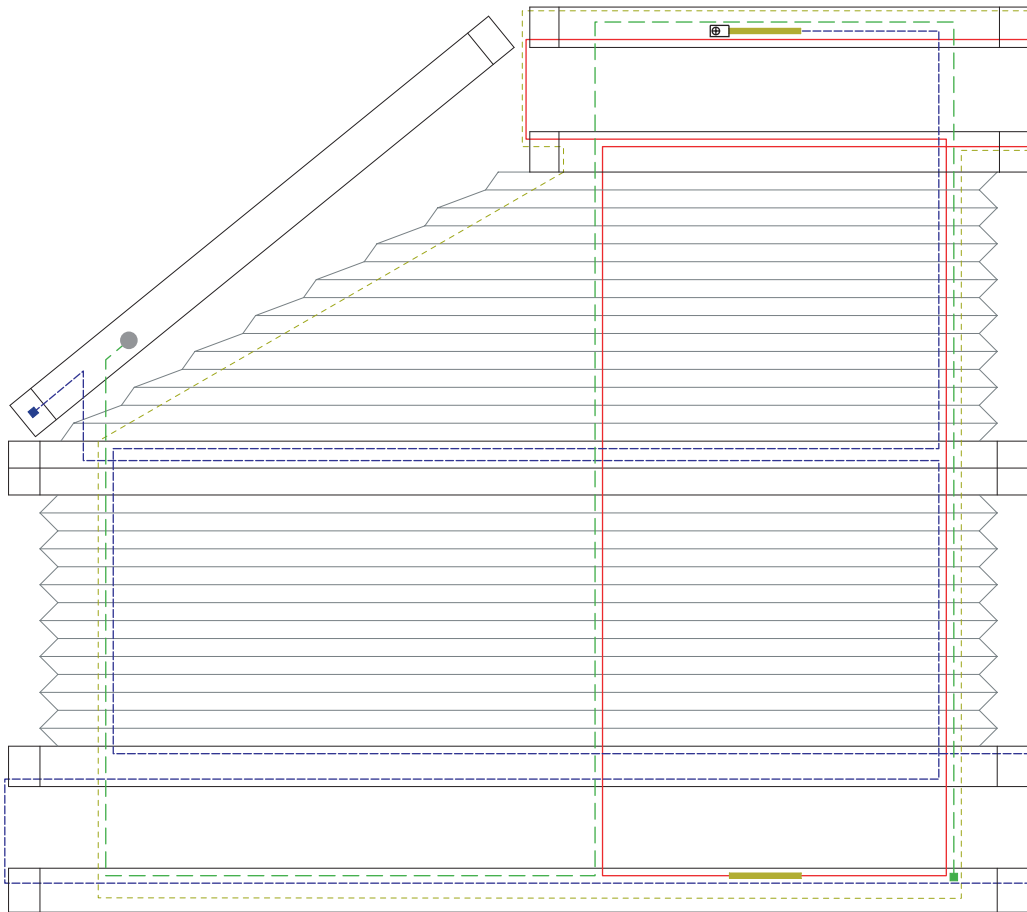

-  Gummiband/Rubber band/Ruban en caoutchouc Ø1,25 mm
-  Drahtspanner/Wire stretcher/Tendeur de fil
-  Zugfeder/Tension spring/Ressort de traction Ø0,7 x 44 mm





3 Drahtbohrungen/Wire boreholes/Passages de fil



P 3660-2

-  1. Plisseeschnur/Pleating cord/Cordon à plisser Ø0,8 mm
-  2. Plisseeschnur/Pleating cord/Cordon à plisser Ø0,8 mm
-  Spanndraht/Tension wire/Fil de tension Ø0,8 mm
-  Stoppschnur/Stop cord/Cordon d'arrêt Ø0,8 mm

-  Gummiband/Rubber band/Ruban en caoutchouc Ø1,25 mm
-  Drahtspanner/Wire stretcher/Tendeur de fil
-  Zugfeder/Tension spring/Ressort de traction Ø0,7 x 44 mm

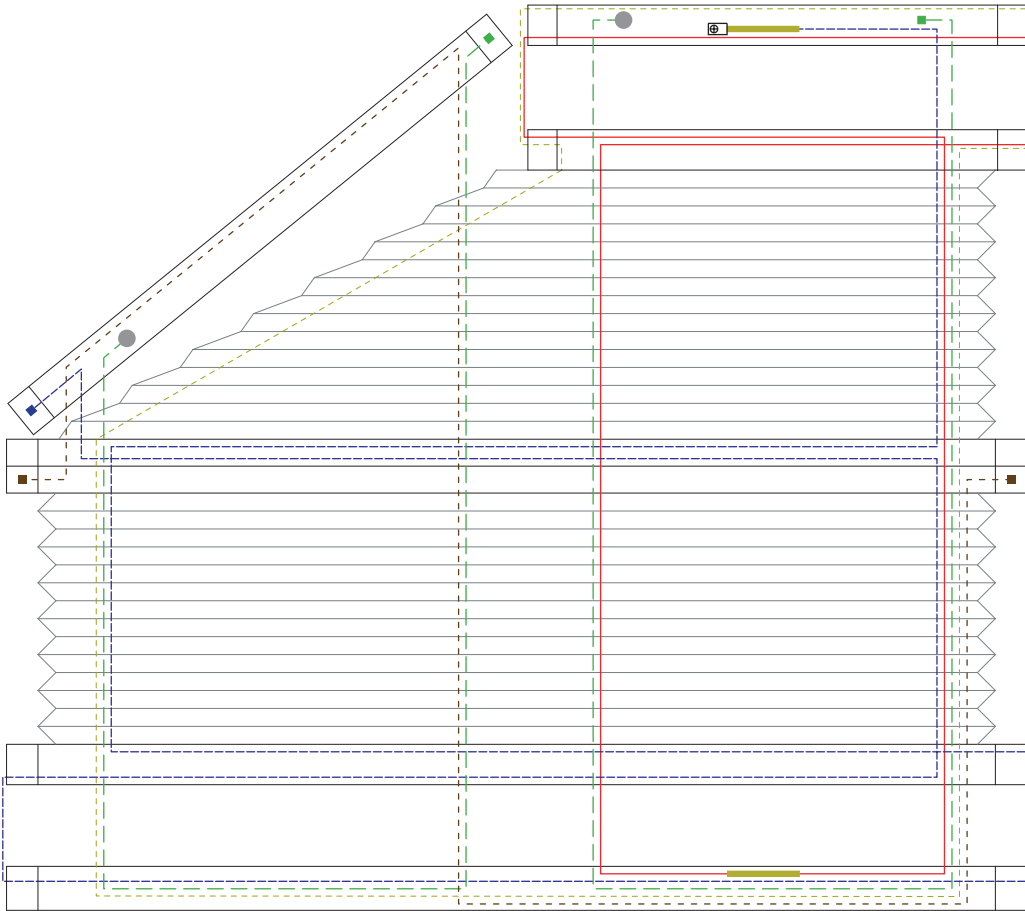



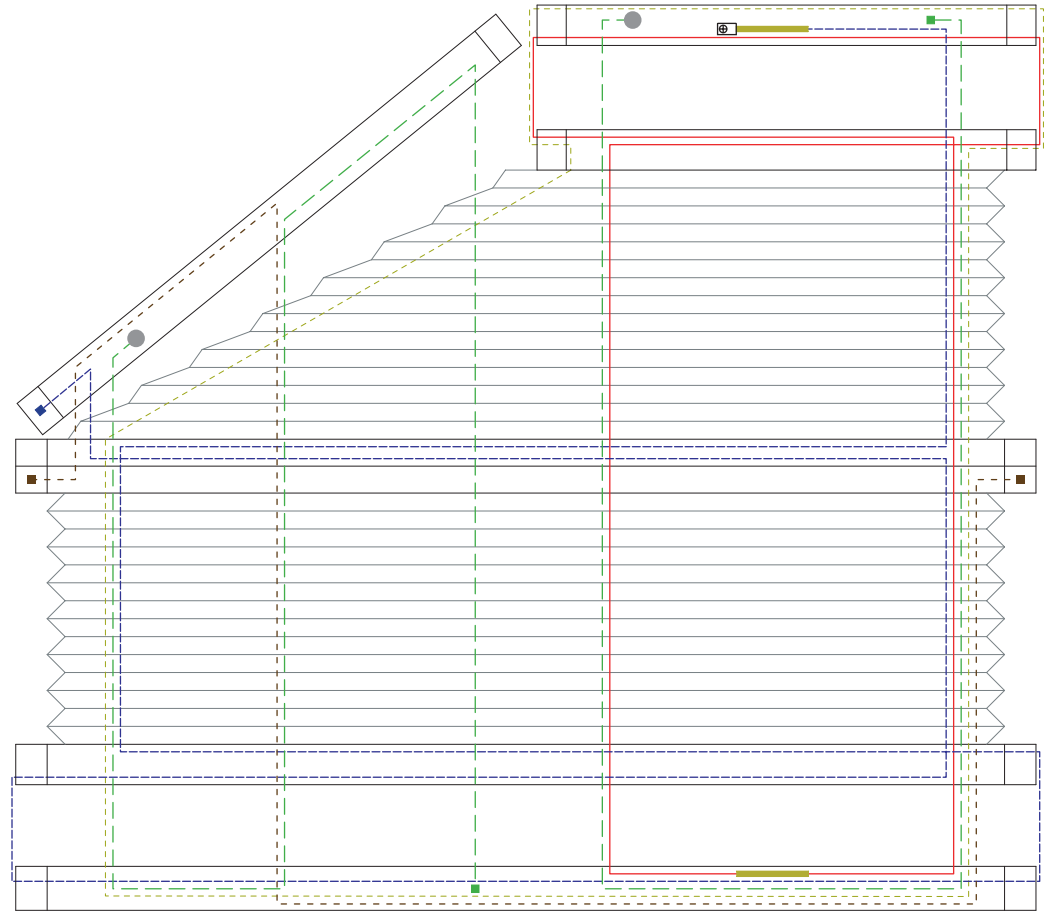

4 Drahtbohrungen/Wire boreholes/Passages de fil





5 Drahtbohrungen/Wire boreholes/Passages de fil



P 3660-2

-  1. Plisseeschnur/Pleating cord/Cordon à plisser Ø0,8 mm
-  2. Plisseeschnur/Pleating cord/Cordon à plisser Ø0,8 mm
-  Spanndraht/Tension wire/Fil de tension Ø0,8 mm
-  Stoppschnur/Stop cord/Cordon d'arrêt Ø0,8 mm

-  Gummiband/Rubber band/Ruban en caoutchouc Ø1,25 mm
-  Drahtspanner/Wire stretcher/Tendeur de fil
-  Zugfeder/Tension spring/Ressort de traction Ø0,7 x 44 mm

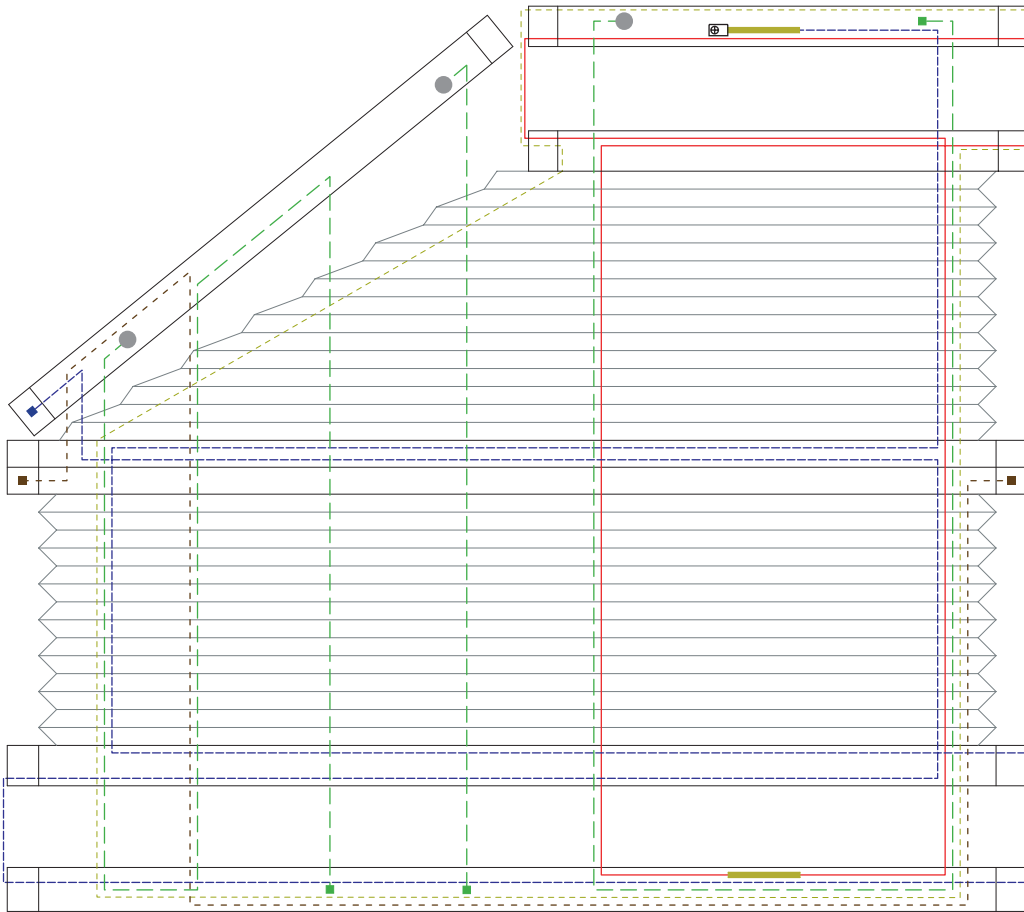



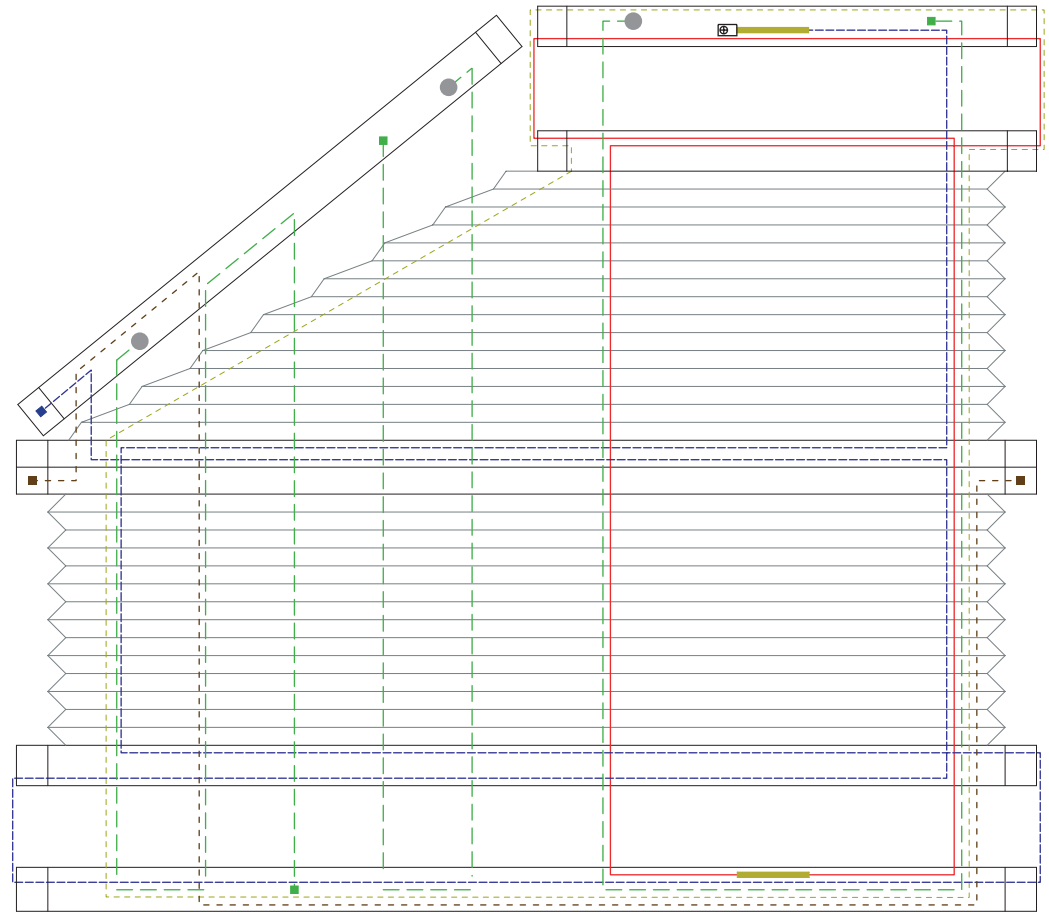

6 Drahtbohrungen/Wire boreholes/Passages de fil





7 Drahtbohrungen/Wire boreholes/Passages de fil



P 3660-3

-  1. Plisseeschnur/Pleating cord/Cordon à plisser Ø0,8 mm
-  2. Plisseeschnur/Pleating cord/Cordon à plisser Ø0,8 mm
-  Spanndraht/Tension wire/Fil de tension Ø0,8 mm
-  Stoppschnur/Stop cord/Cordon d'arrêt Ø0,8 mm

-  Gummiband/Rubber band/Ruban en caoutchouc Ø1,25 mm
-  Drahtspanner/Wire stretcher/Tendeur de fil
-  Zugfeder/Tension spring/Ressort de traction Ø0,7 x 44 mm

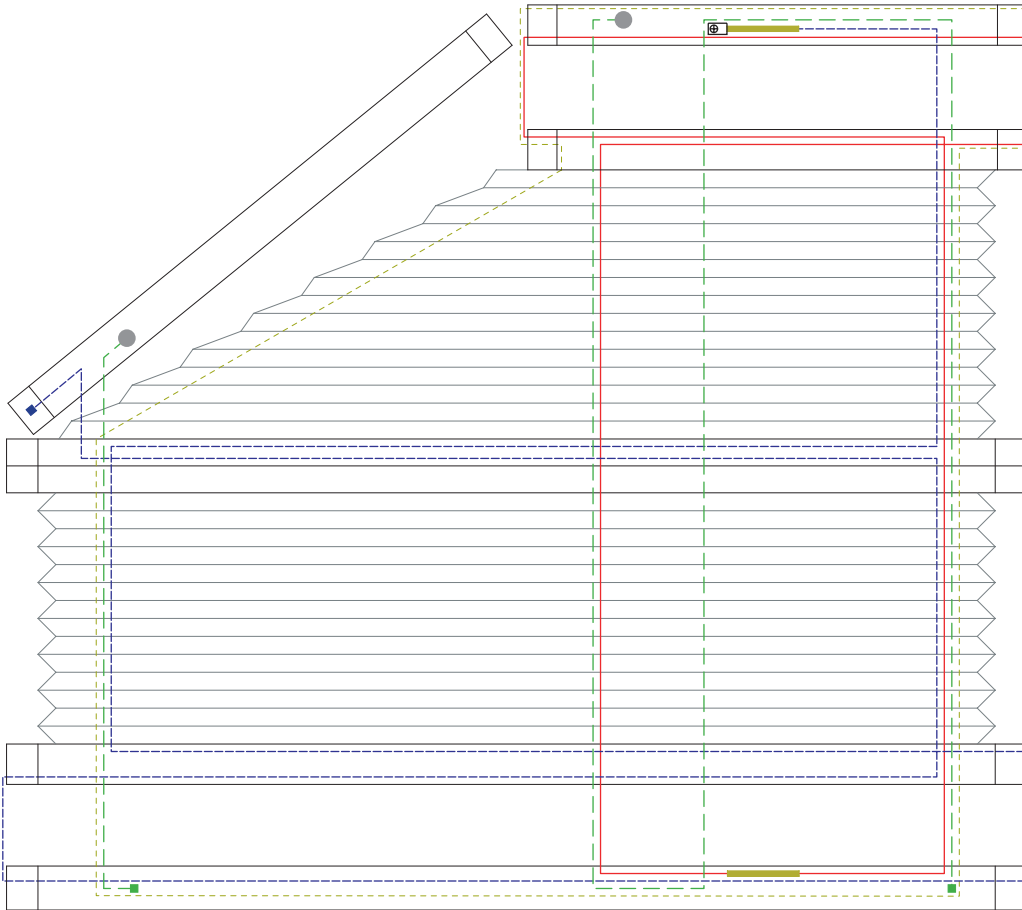

4 Drahtbohrungen/Wire boreholes/Passages de fil

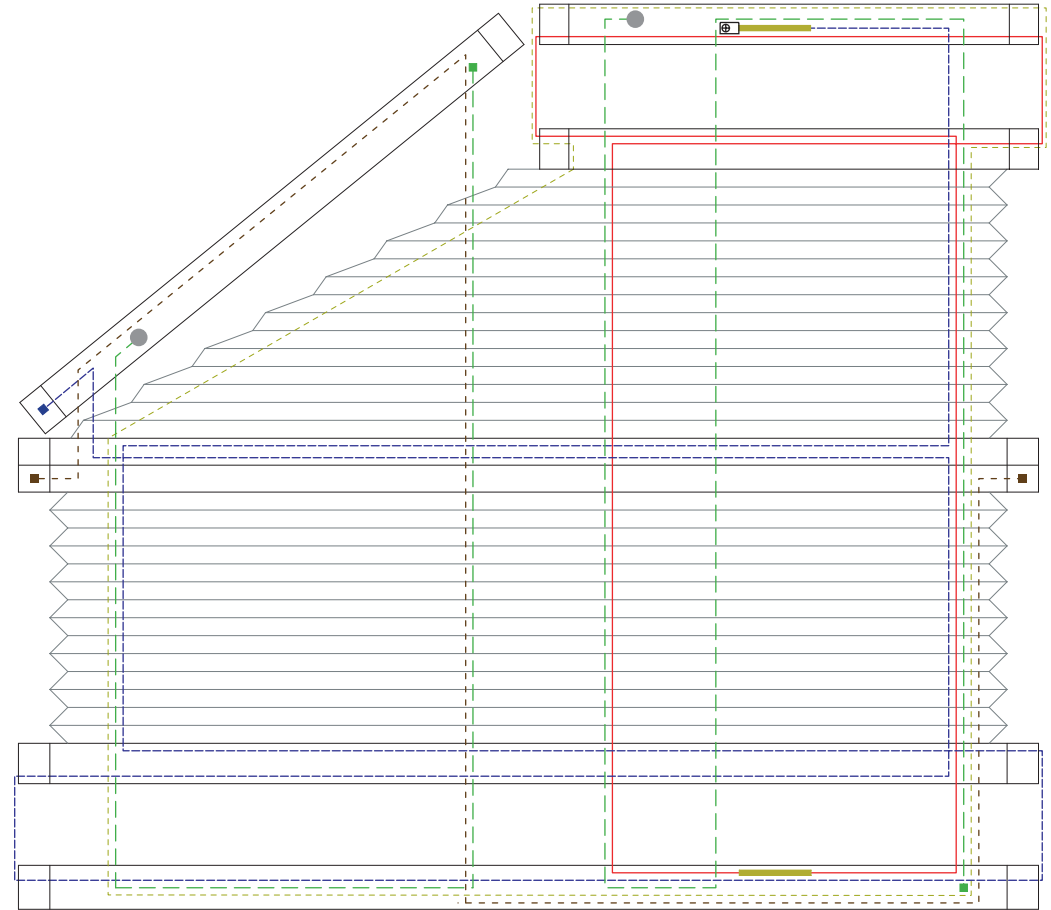

5 Drahtbohrungen/Wire boreholes/Passages de fil



P 3660-3

- 1. Plisseeschnur/Pleating cord/Cordon à plisser Ø0,8 mm
- - - 2. Plisseeschnur/Pleating cord/Cordon à plisser Ø0,8 mm
- - - Spanndraht/Tension wire/Fil de tension Ø0,8 mm
- - - Stoppschnur/Stop cord/Cordon d'arrêt Ø0,8 mm

- - - Gummiband/Rubber band/Ruban en caoutchouc Ø1,25 mm
- Drahtspanner/Wire stretcher/Tendeur de fil
- Zugfeder/Tension spring/Ressort de traction Ø0,7 x 44 mm

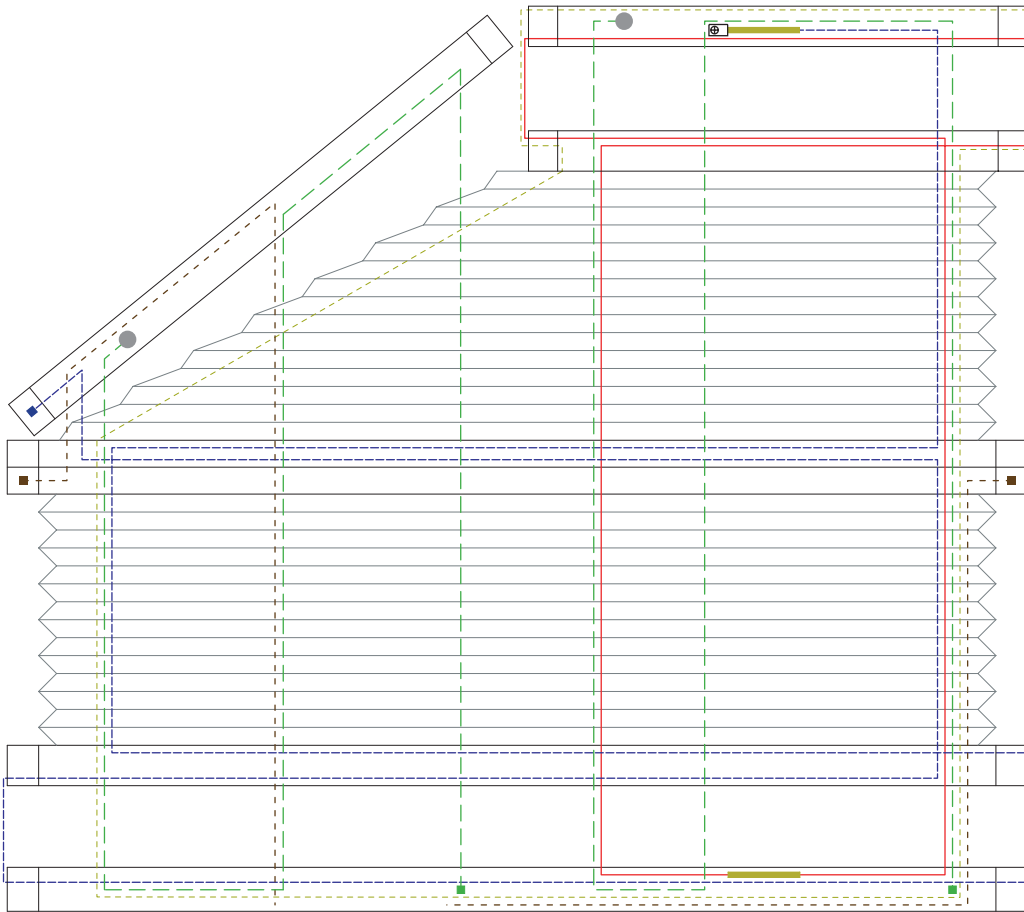



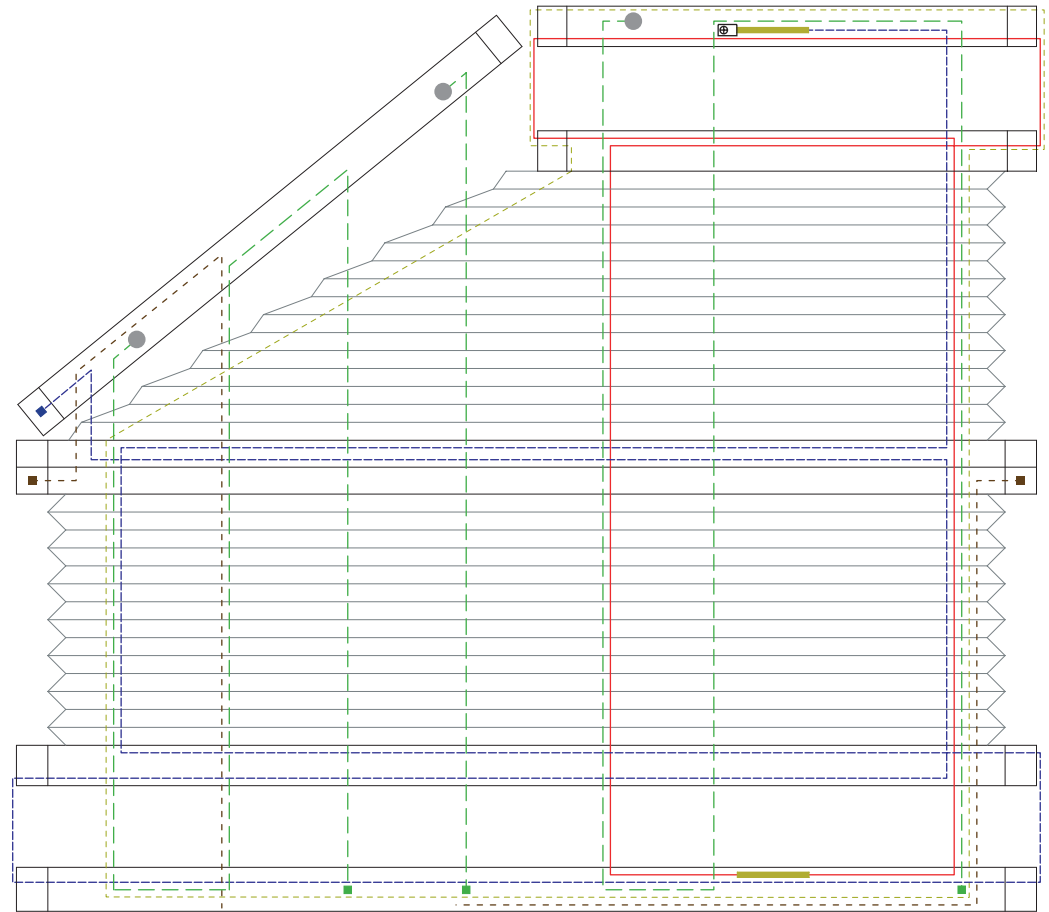

6 Drahtbohrungen/Wire boreholes/Passages de fil





7 Drahtbohrungen/Wire boreholes/Passages de fil



P 3660-4

-  1. Plisseeschnur/Pleating cord/Cordon à plisser Ø0,8 mm
-  2. Plisseeschnur/Pleating cord/Cordon à plisser Ø0,8 mm
-  Spanndraht/Tension wire/Fil de tension Ø0,8 mm
-  Stoppschnur/Stop cord/Cordon d'arrêt Ø0,8 mm

-  Gummiband/Rubber band/Ruban en caoutchouc Ø1,25 mm
-  Drahtspanner/Wire stretcher/Tendeur de fil
-  Zugfeder/Tension spring/Ressort de traction Ø0,7 x 44 mm

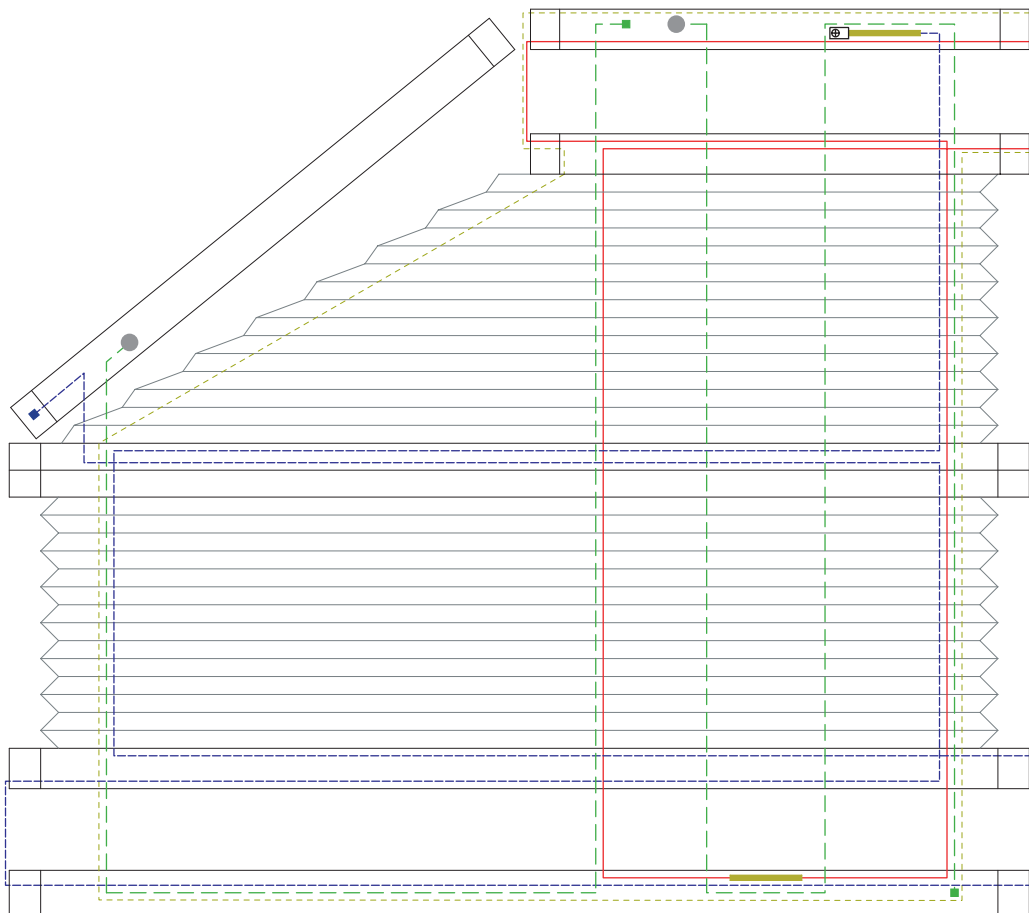

5 Drahtbohrungen/Wire boreholes/Passages de fil



P 3660-4

- 1. Plisseeschnur/Pleating cord/Cordon à plisser Ø0,8 mm
- - - 2. Plisseeschnur/Pleating cord/Cordon à plisser Ø0,8 mm
- - - Spanndraht/Tension wire/Fil de tension Ø0,8 mm
- - - Stoppschnur/Stop cord/Cordon d'arrêt Ø0,8 mm

- - - Gummiband/Rubber band/Ruban en caoutchouc Ø1,25 mm
- Drahtspanner/Wire stretcher/Tendeur de fil
- Zugfeder/Tension spring/Ressort de traction Ø0,7 x 44 mm

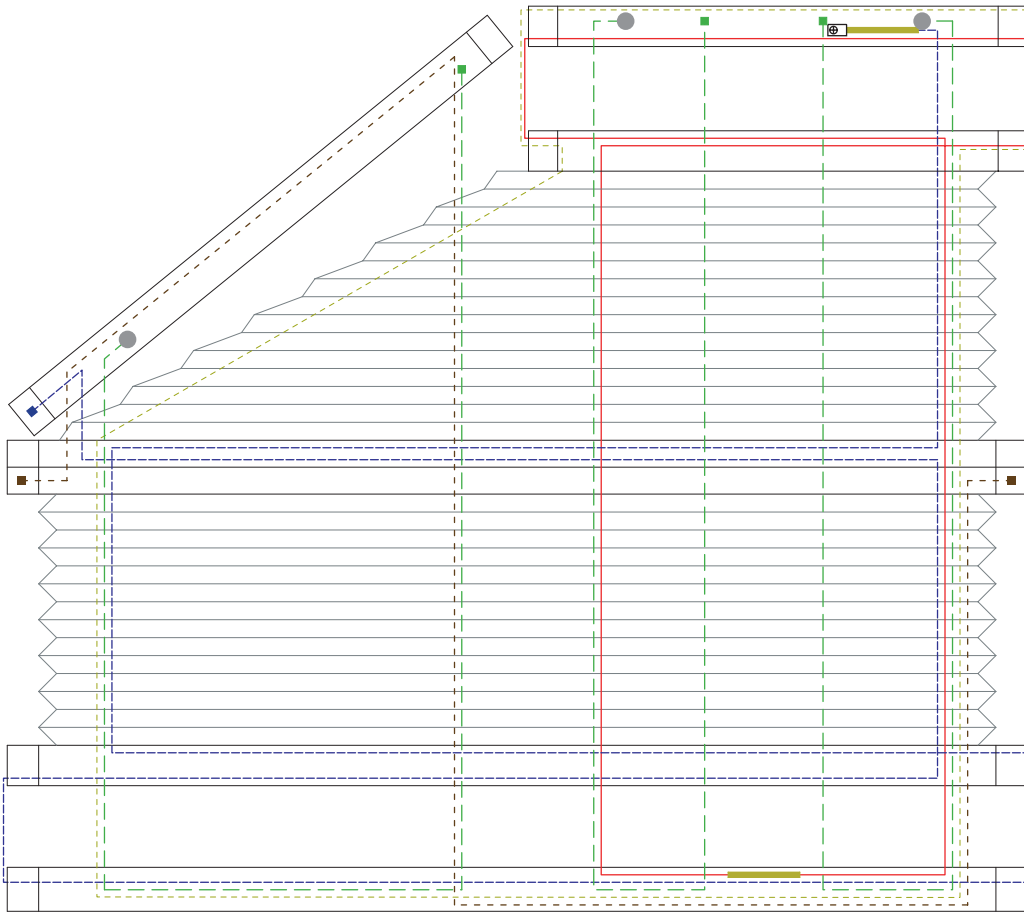



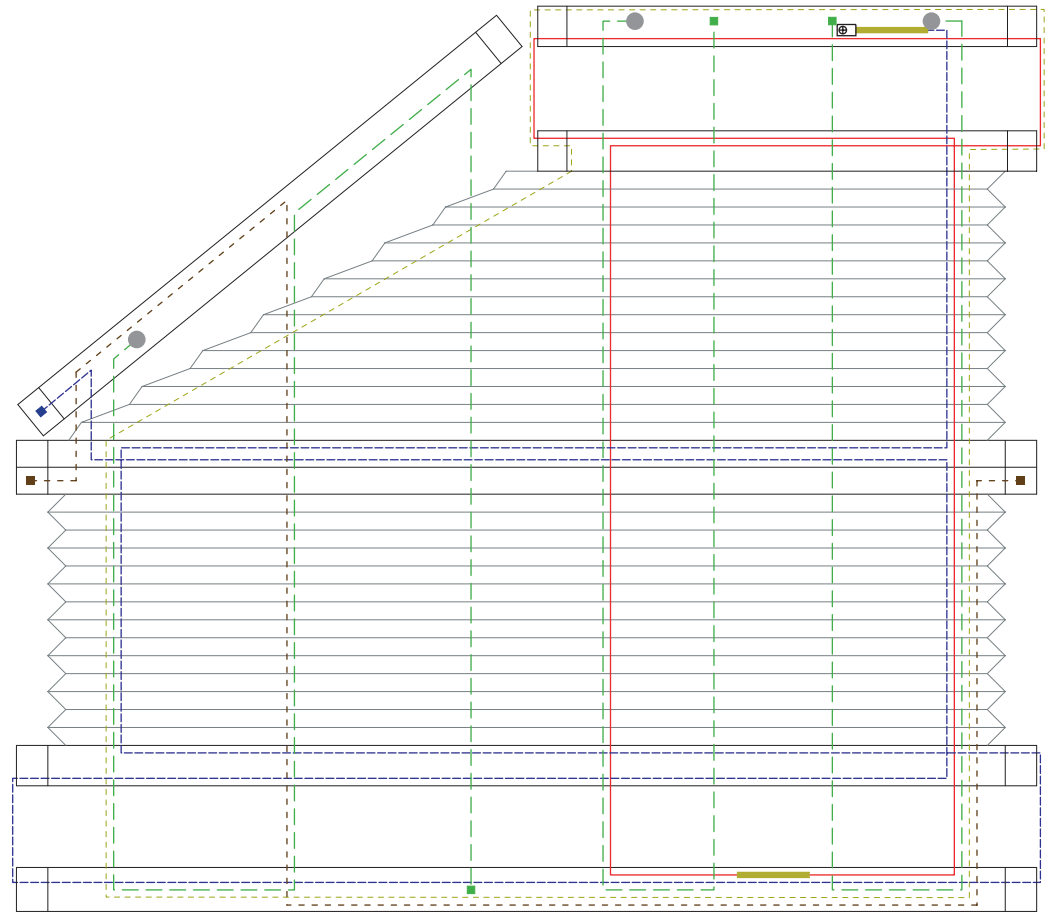

6 Drahtbohrungen/Wire boreholes/Passages de fil





7 Drahtbohrungen/Wire boreholes/Passages de fil



P 3660-5

-  1. Plisseeschnur/Pleating cord/Cordon à plisser Ø0,8 mm
-  2. Plisseeschnur/Pleating cord/Cordon à plisser Ø0,8 mm
-  Spanndraht/Tension wire/Fil de tension Ø0,8 mm
-  Stoppschnur/Stop cord/Cordon d'arrêt Ø0,8 mm

-  Gummiband/Rubber band/Ruban en caoutchouc Ø1,25 mm
-  Drahtspanner/Wire stretcher/Tendeur de fil
-  Zugfeder/Tension spring/Ressort de traction Ø0,7 x 44 mm

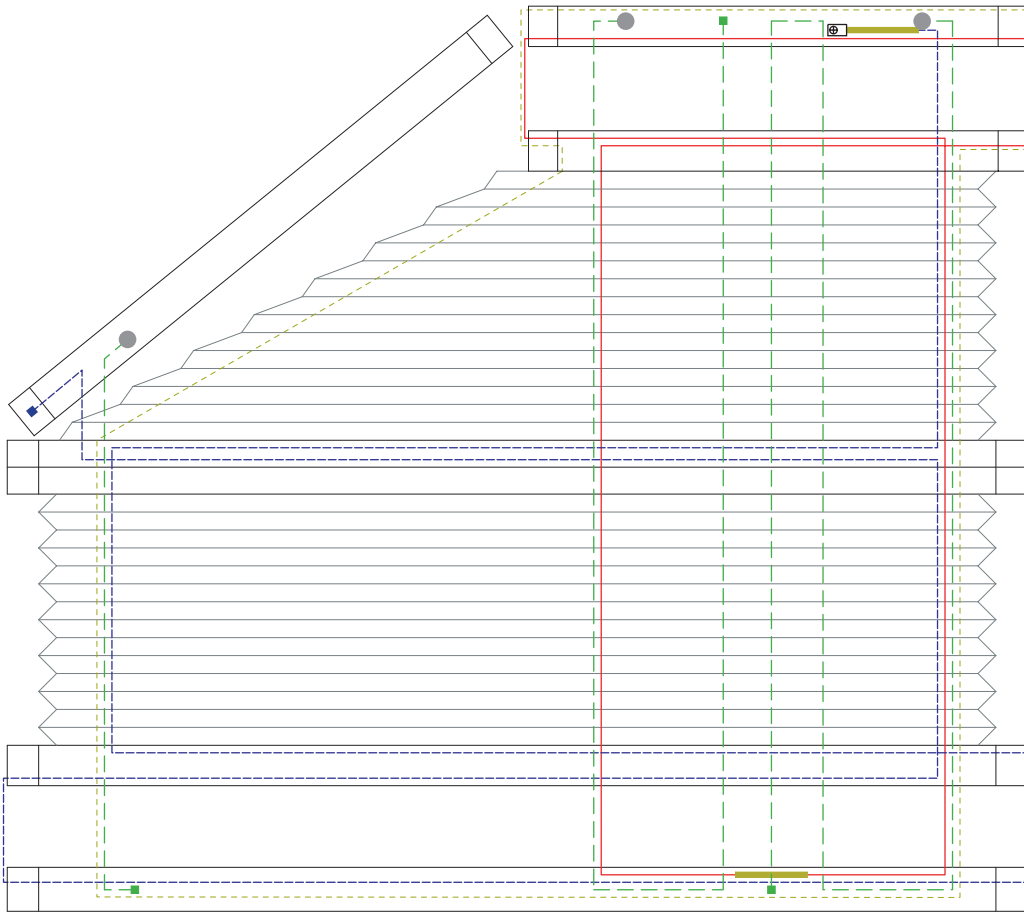



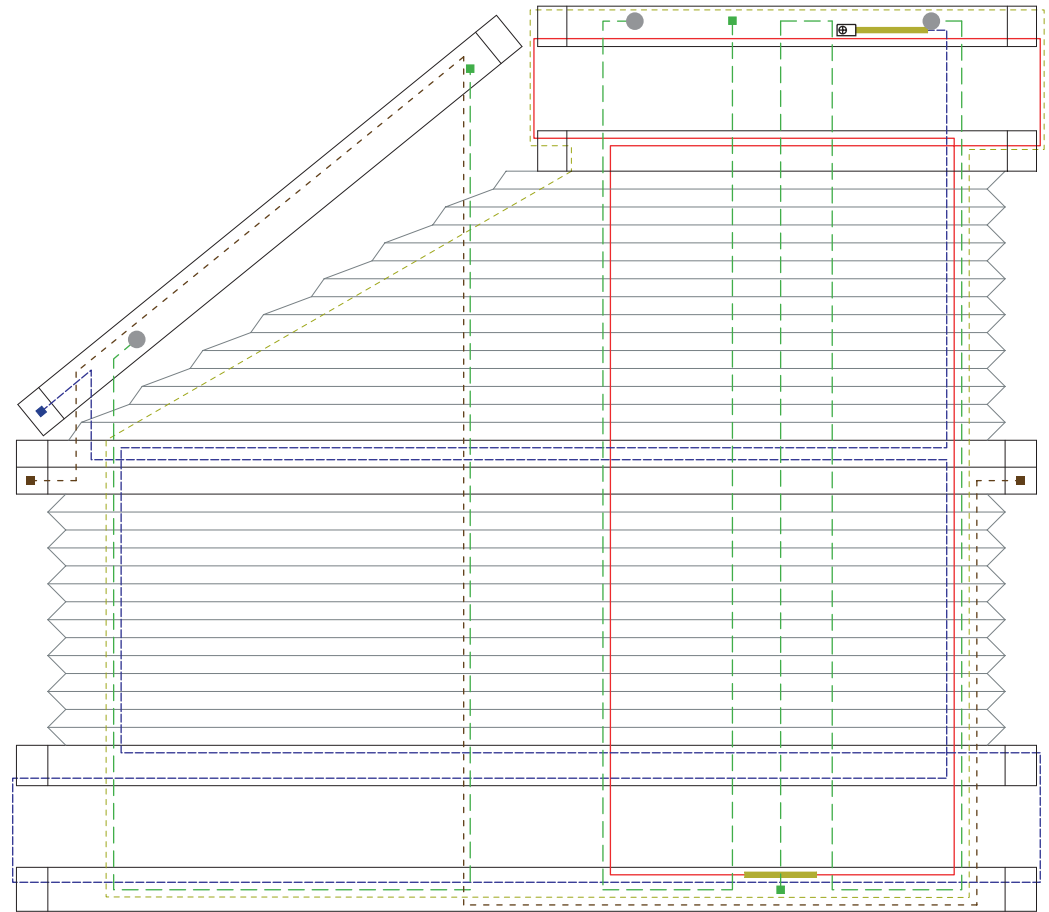

6 Drahtbohrungen/Wire boreholes/Passages de fil





7 Drahtbohrungen/Wire boreholes/Passages de fil



P 3660-6

-  1. Plisseeschnur/Pleating cord/Cordon à plisser Ø0,8 mm
-  2. Plisseeschnur/Pleating cord/Cordon à plisser Ø0,8 mm
-  Spanndraht/Tension wire/Fil de tension Ø0,8 mm
-  Stoppschnur/Stop cord/Cordon d'arrêt Ø0,8 mm



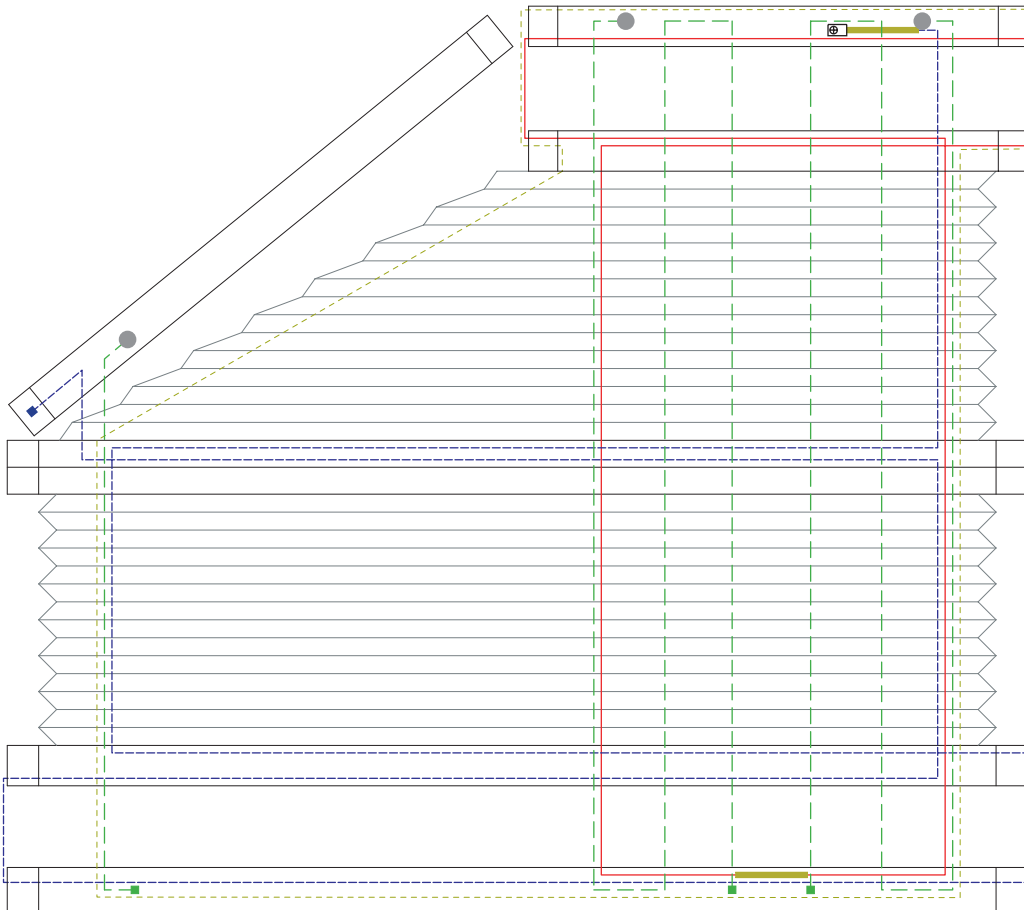

-  Gummiband/Rubber band/Ruban en caoutchouc Ø1,25 mm
-  Drahtspanner/Wire stretcher/Tendeur de fil
-  Zugfeder/Tension spring/Ressort de traction Ø0,7 x 44 mm





7 Drahtbohrungen/Wire boreholes/Passages de fil



P 3661-2

-  1. Plisseeschnur/Pleating cord/Cordon à plisser Ø0,8 mm
-  2. Plisseeschnur/Pleating cord/Cordon à plisser Ø0,8 mm
-  Spanndraht/Tension wire/Fil de tension Ø0,8 mm
-  Gummiband/Rubber band/Ruban en caoutchouc Ø1,25 mm



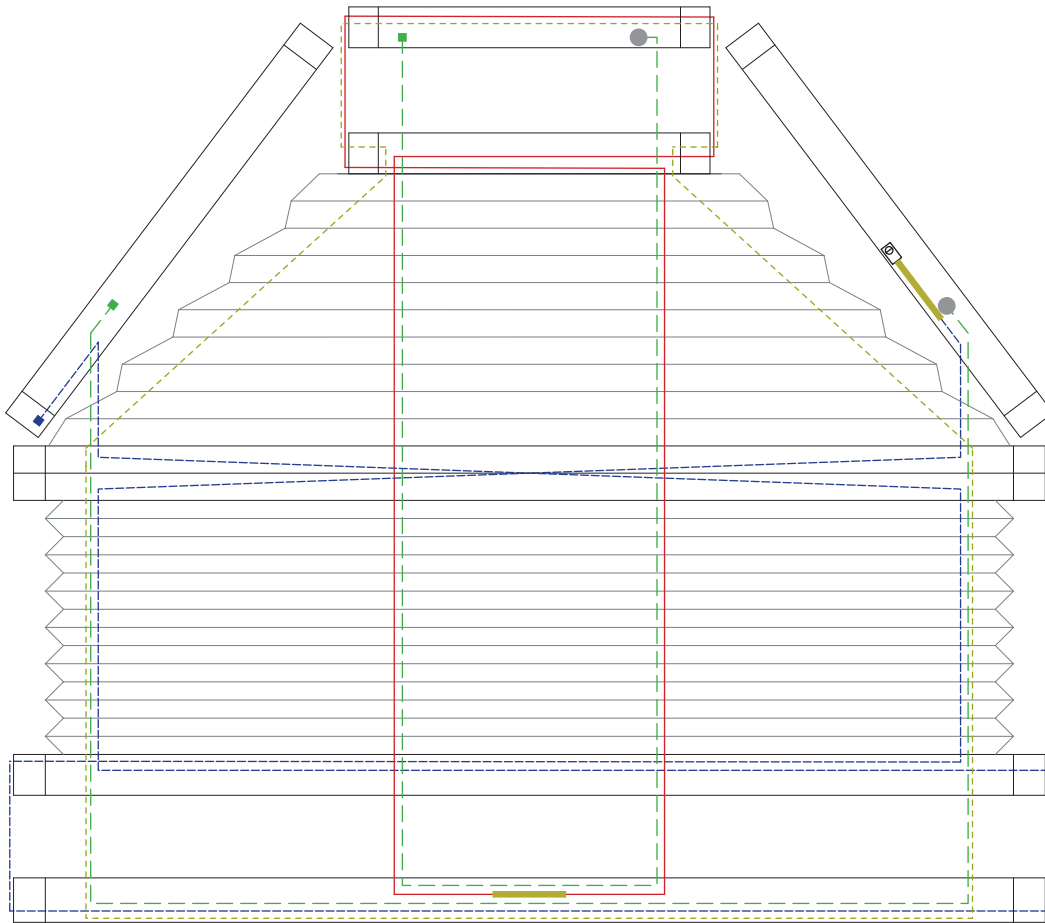

-  Drahtspanner/Wire stretcher/Tendeur de fil
-  Zugfeder/Tension spring/Ressort de traction Ø0,7 x 44 mm





4 Drahtbohrungen/Wire boreholes/Passages de fil



P 3661-2

-  1. Plisseeschnur/Pleating cord/Cordon à plisser Ø0,8 mm
-  2. Plisseeschnur/Pleating cord/Cordon à plisser Ø0,8 mm
-  Spanndraht/Tension wire/Fil de tension Ø0,8 mm
-  Gummiband/Rubber band/Ruban en caoutchouc Ø1,25 mm

-  Drahtspanner/Wire stretcher/Tendeur de fil
-  Zugfeder/Tension spring/Ressort de traction Ø0,7 x 44 mm

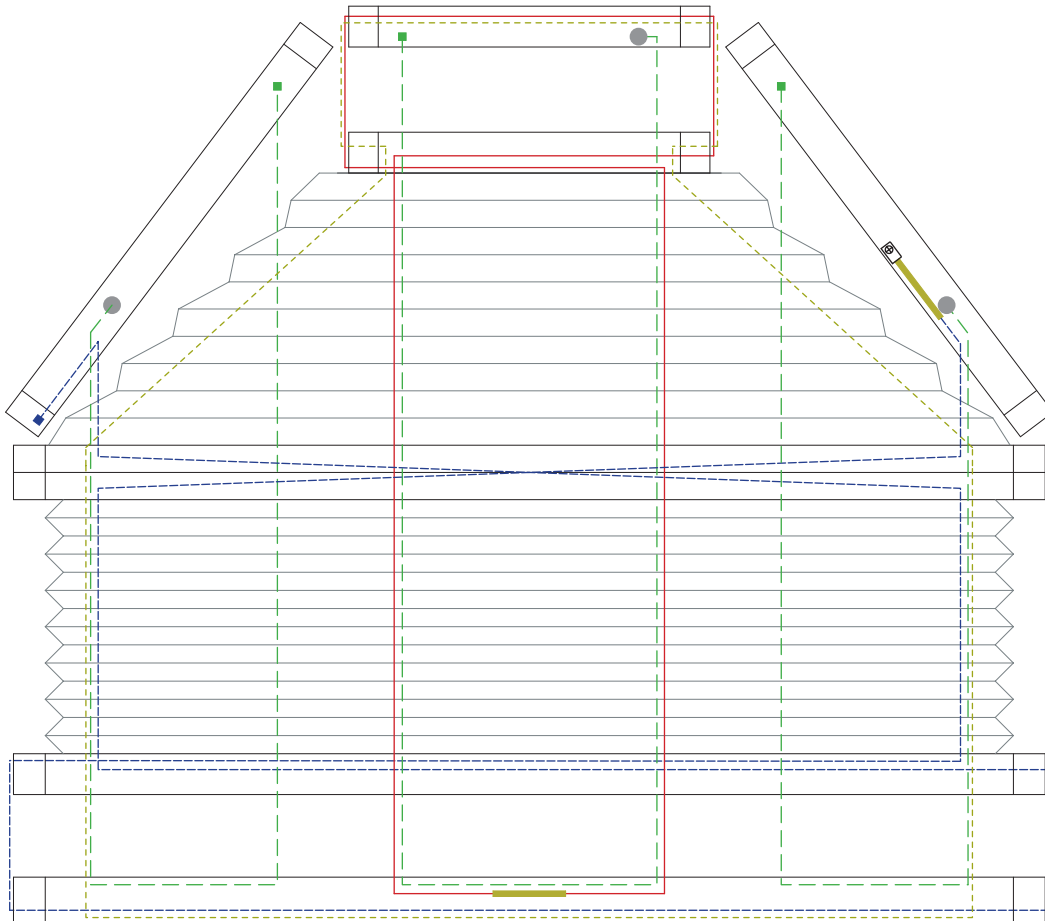



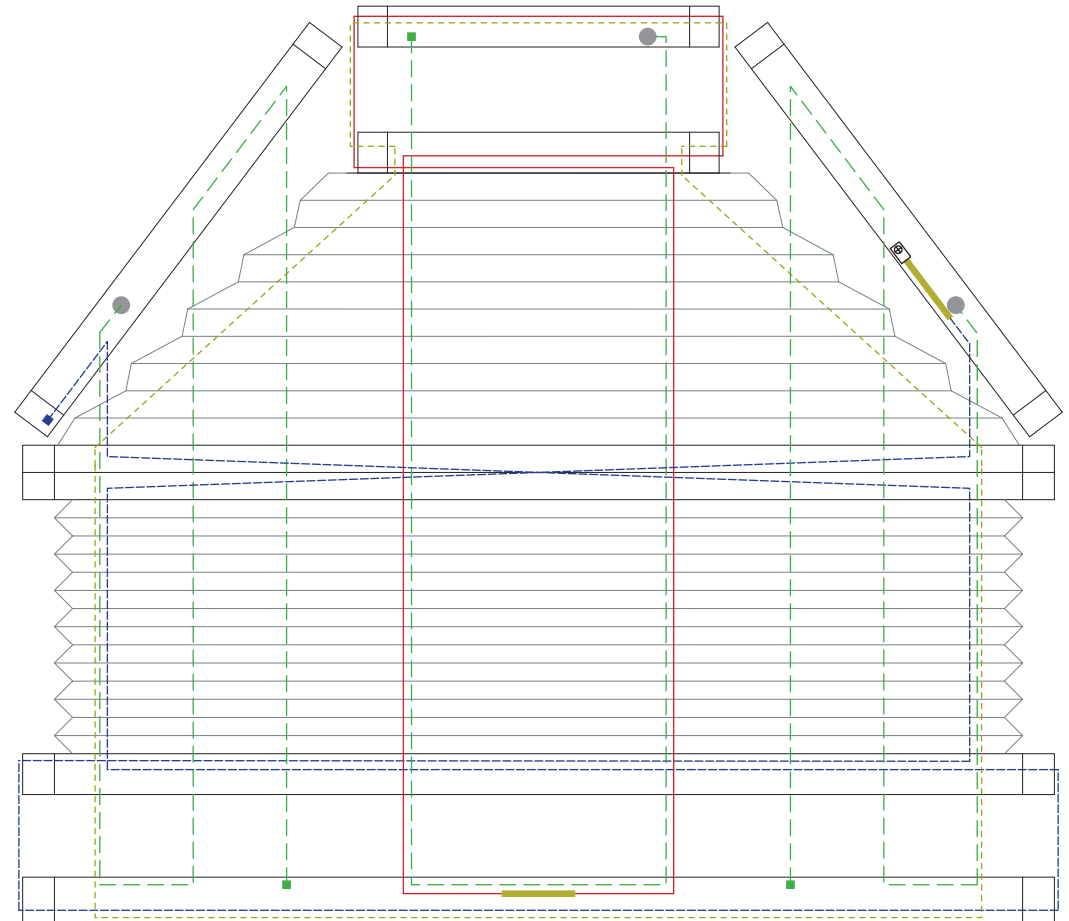

6 Drahtbohrungen/Wire boreholes/Passages de fil





8 Drahtbohrungen/Wire boreholes/Passages de fil



P 3661-3

-  1. Plisseeschnur/Pleating cord/Cordon à plisser Ø0,8 mm
-  2. Plisseeschnur/Pleating cord/Cordon à plisser Ø0,8 mm
-  Spanndraht/Tension wire/Fil de tension Ø0,8 mm
-  Gummiband/Rubber band/Ruban en caoutchouc Ø1,25 mm

-  Drahtspanner/Wire stretcher/Tendeur de fil
-  Zugfeder/Tension spring/Ressort de traction Ø0,7 x 44 mm

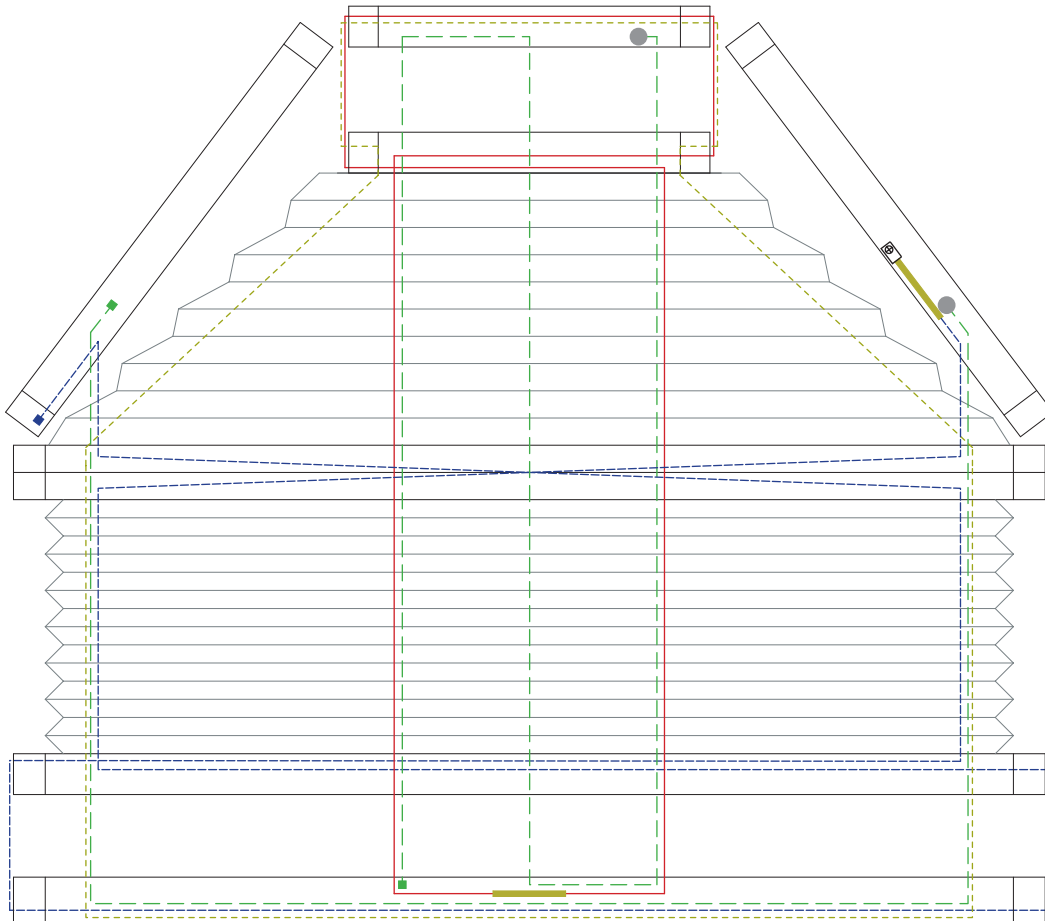

5 Drahtbohrungen/Wire boreholes/Passages de fil

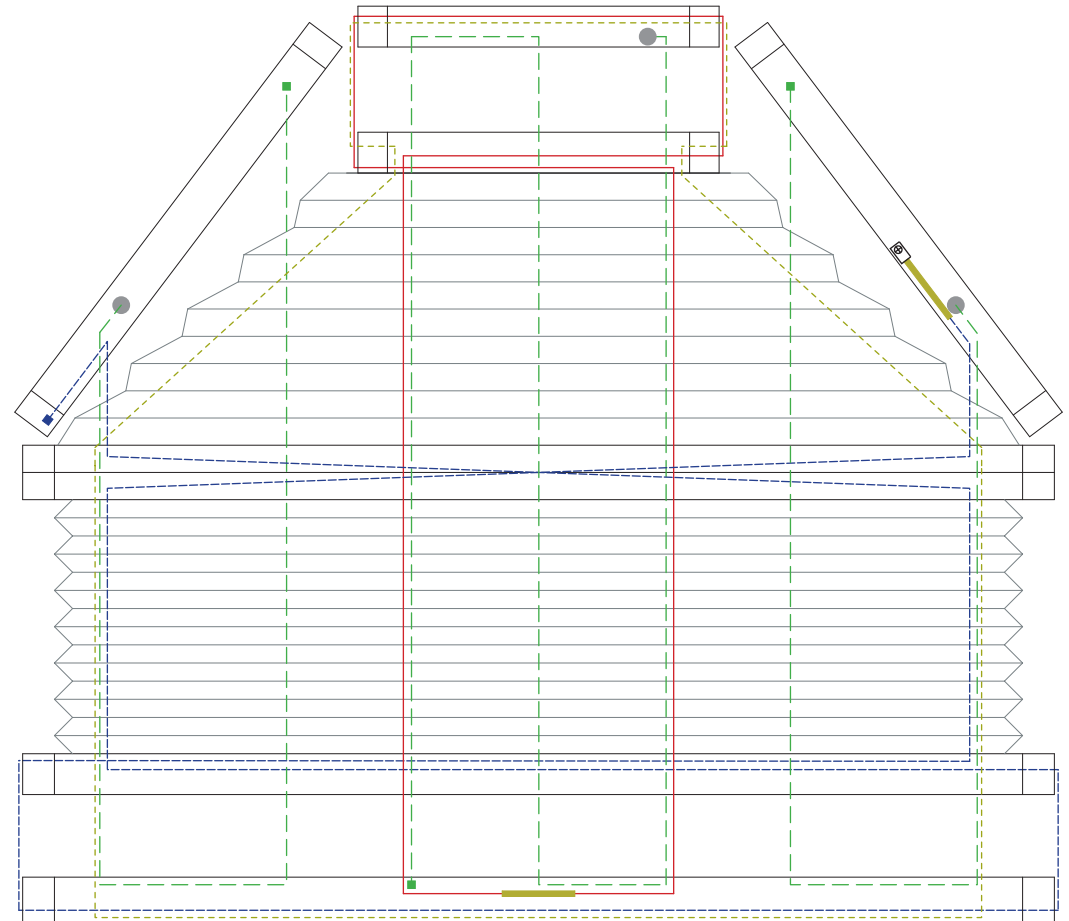

7 Drahtbohrungen/Wire boreholes/Passages de fil



P 3661-4

- 1. Plisseeschnur/Pleating cord/Cordon à plisser Ø0,8 mm
- - - 2. Plisseeschnur/Pleating cord/Cordon à plisser Ø0,8 mm
- - - Spanndraht/Tension wire/Fil de tension Ø0,8 mm
- - - Gummiband/Rubber band/Ruban en caoutchouc Ø1,25 mm

- Drahtspanner/Wire stretcher/Tendeur de fil
- ▬ Zugfeder/Tension spring/Ressort de traction Ø0,7 x 44 mm

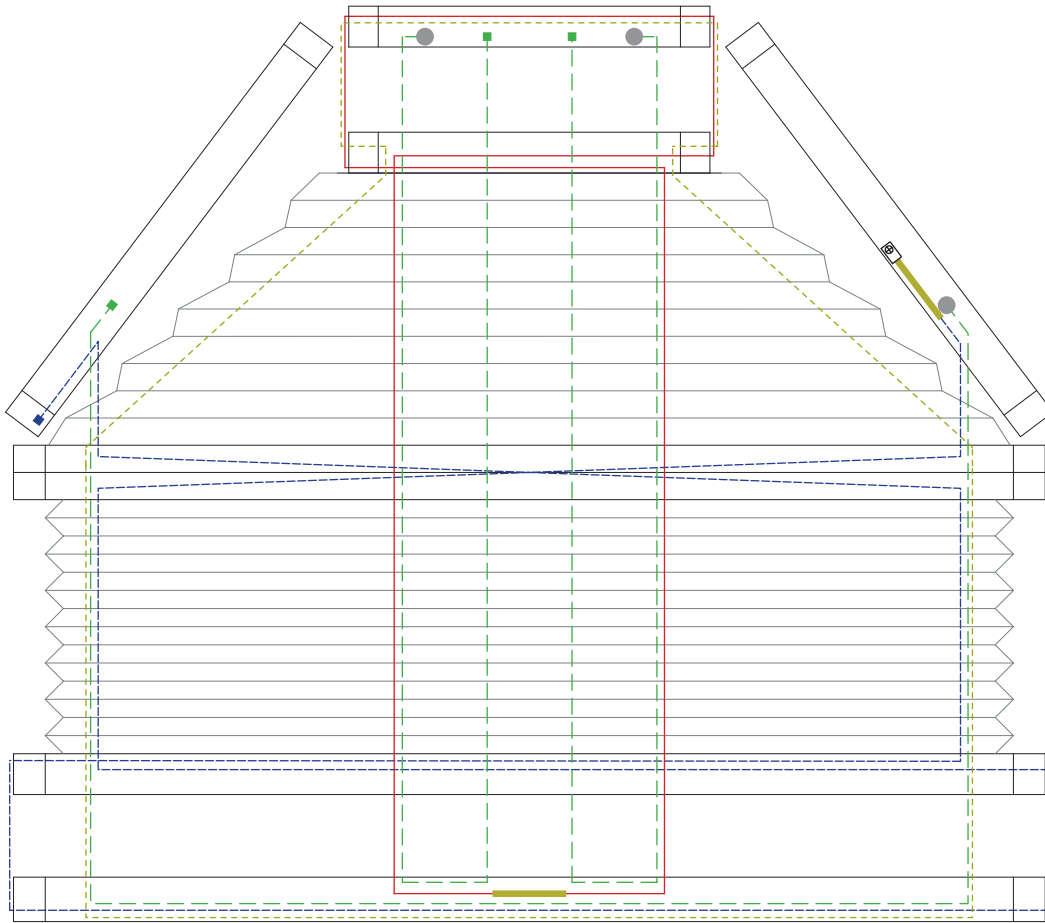



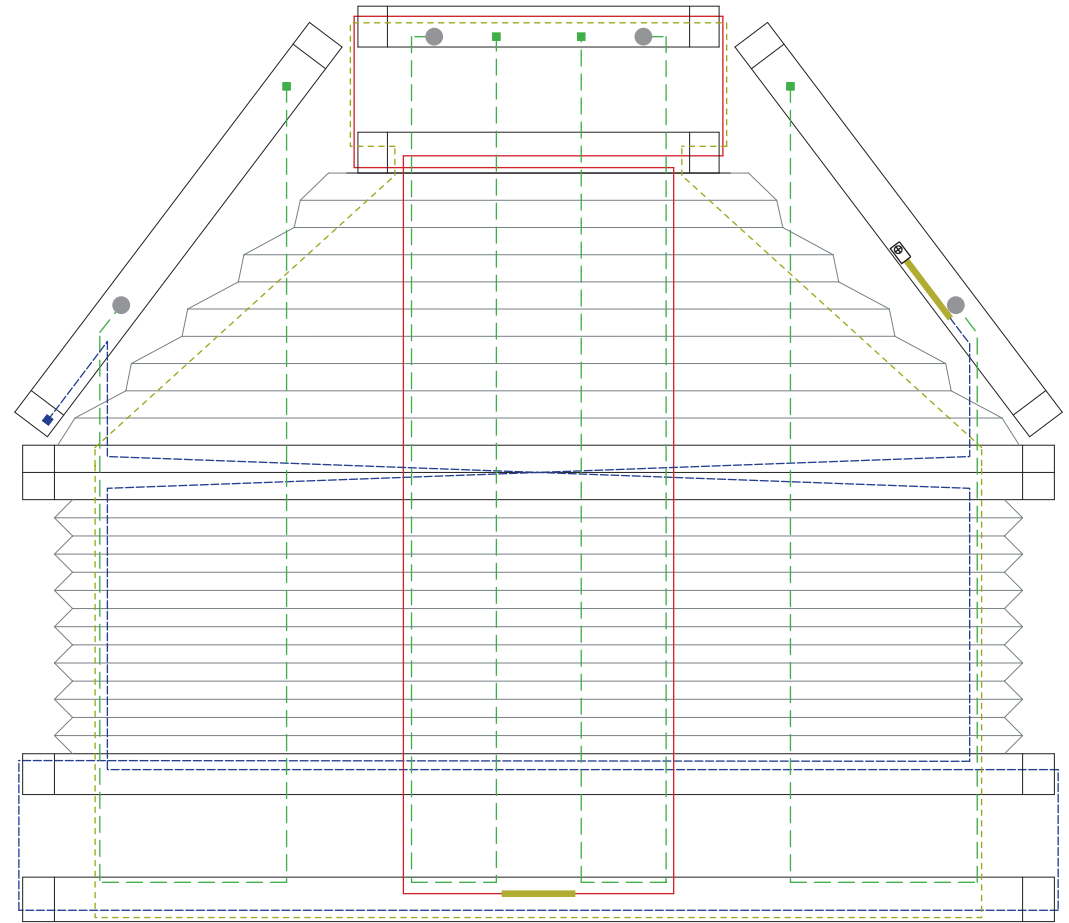

6 Drahtbohrungen/Wire boreholes/Passages de fil





8 Drahtbohrungen/Wire boreholes/Passages de fil



P 3661-5

-  1. Plisseeschnur/Pleating cord/Cordon à plisser Ø0,8 mm
-  2. Plisseeschnur/Pleating cord/Cordon à plisser Ø0,8 mm
-  Spanndraht/Tension wire/Fil de tension Ø0,8 mm
-  Gummiband/Rubber band/Ruban en caoutchouc Ø1,25 mm



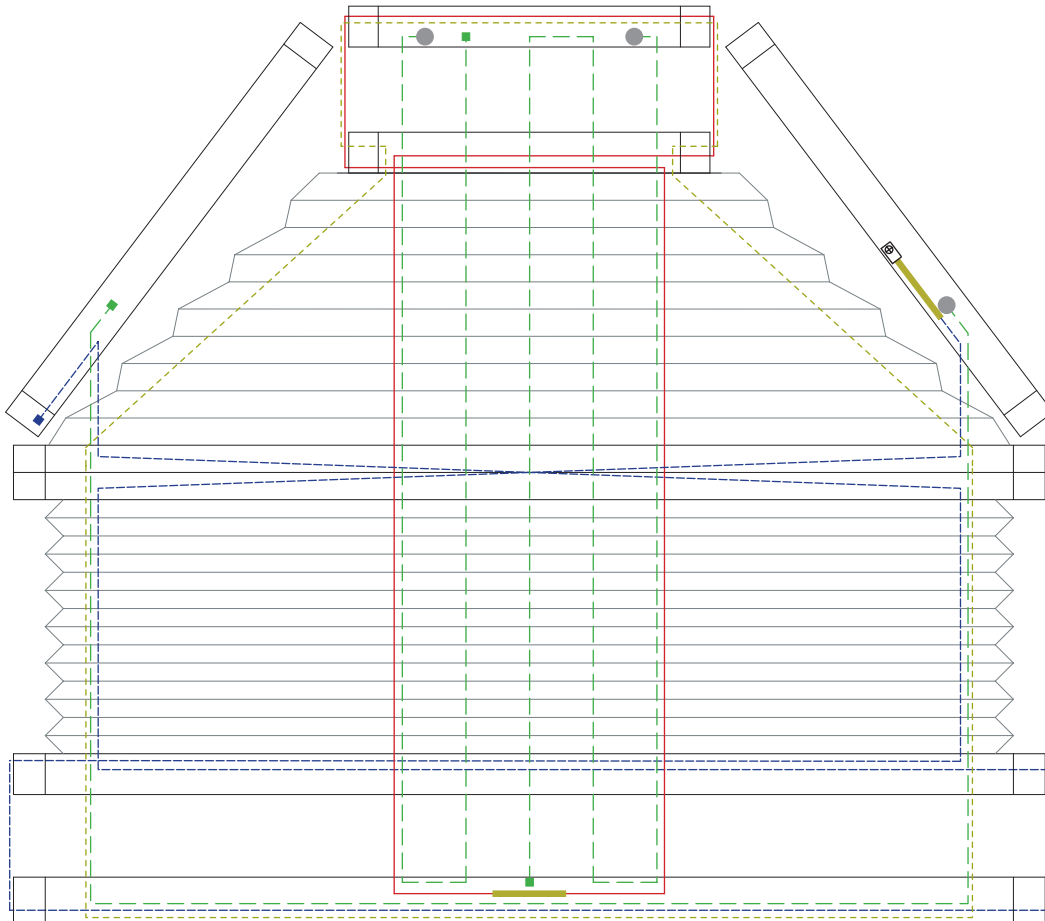

-  Drahtspanner/Wire stretcher/Tendeur de fil
-  Zugfeder/Tension spring/Ressort de traction Ø0,7 x 44 mm

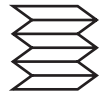



7 Drahtbohrungen/Wire boreholes/Passages de fil



P 3661-6

-  1. Plisseeschnur/Pleating cord/Cordon à plisser Ø0,8 mm
-  2. Plisseeschnur/Pleating cord/Cordon à plisser Ø0,8 mm
-  Spanndraht/Tension wire/Fil de tension Ø0,8 mm
-  Gummiband/Rubber band/Ruban en caoutchouc Ø1,25 mm

-  Drahtspanner/Wire stretcher/Tendeur de fil
-  Zugfeder/Tension spring/Ressort de traction Ø0,7 x 44 mm

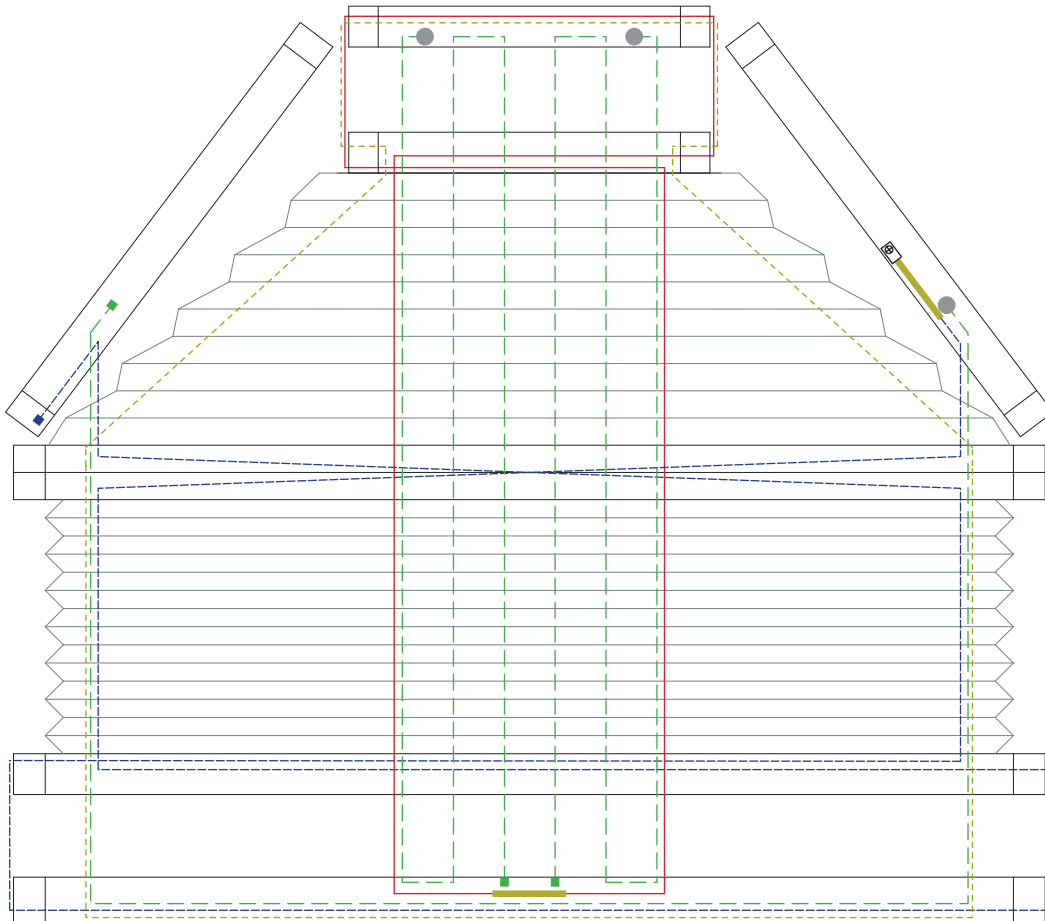

8 Drahtbohrungen/Wire boreholes/Passages de fil



P 3830-1

- 1. Wickelschnur/Winding cord/Cordon d'enroulement Ø1,2 mm
- - - 2. Wickelschnur/Winding cord/Cordon d'enroulement Ø1,2 mm
- SOMFY CTS 25 Schnurwickler/Cord winder/Dévidoir de cordon
- - - Spanndraht/Tension wire/Fil de tension Ø0,8 mm

- Drahtspanner/Wire stretcher/Tendeur de fil
- ⊞ Schnurspanner/Cord stretcher/Tendeur de cordon

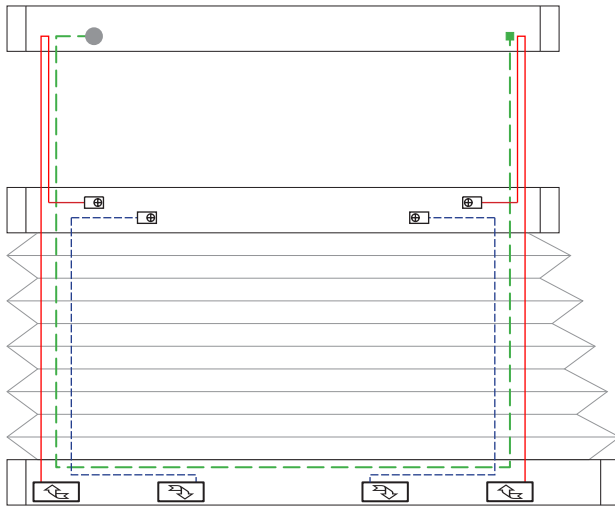

2 Drahtbohrungen/Wire boreholes/Passages de fil

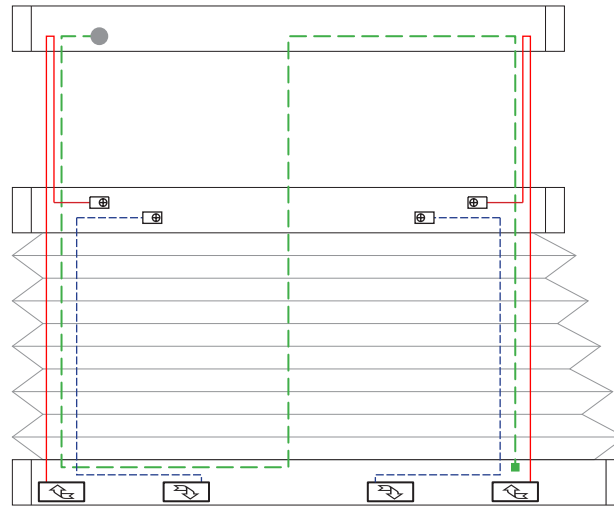

3 Drahtbohrungen/Wire boreholes/Passages de fil

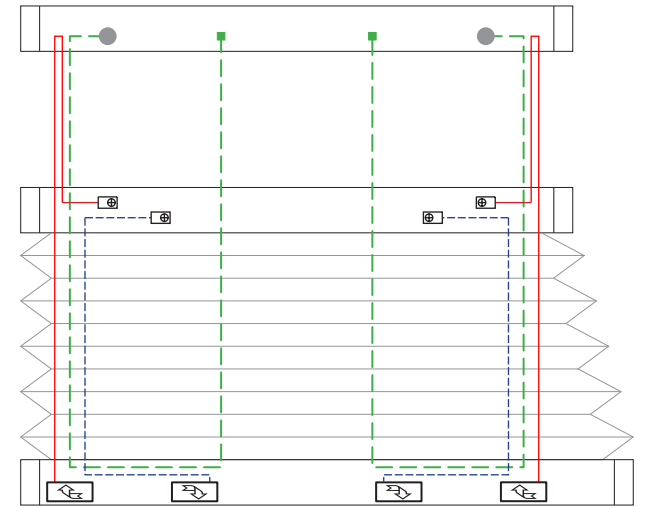

4 Drahtbohrungen/Wire boreholes/Passages de fil

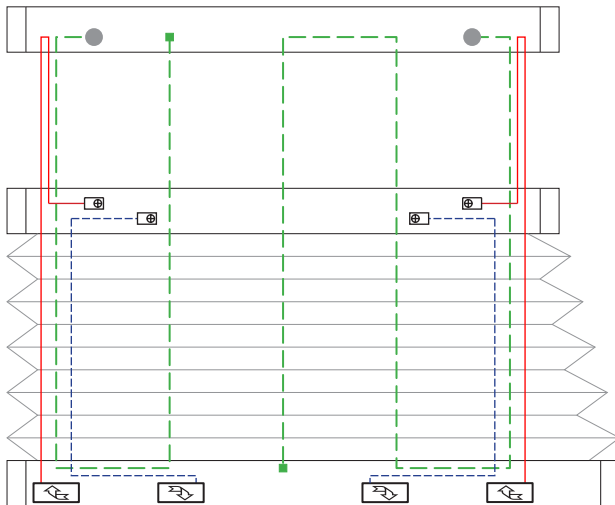

5 Drahtbohrungen/Wire boreholes/Passages de fil

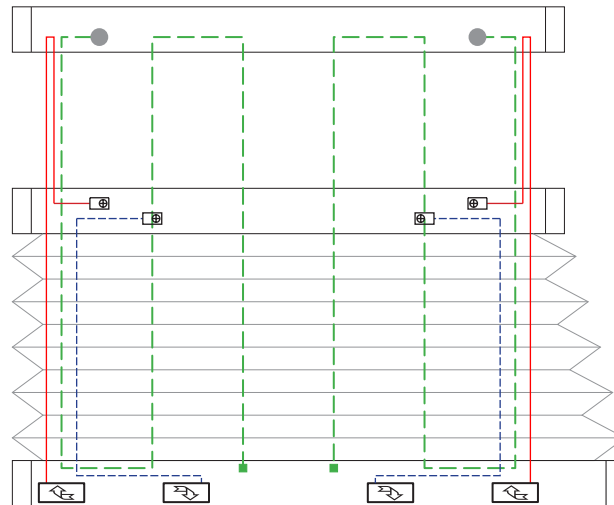

6 Drahtbohrungen/Wire boreholes/Passages de fil



P 3830-2

- 1. Wickelschnur/Winding cord/Cordon d'enroulement Ø1,2 mm
- - - 2. Wickelschnur/Winding cord/Cordon d'enroulement Ø1,2 mm
- SOMFY CTS 25 Schnurwickler/Cord winder/Dévidoir de cordon
- - - Spanndraht/Tension wire/Fil de tension Ø0,8 mm

- Drahtspanner/Wire stretcher/Tendeur de fil
- ⊞ Schnurspanner/Cord stretcher/Tendeur de cordon

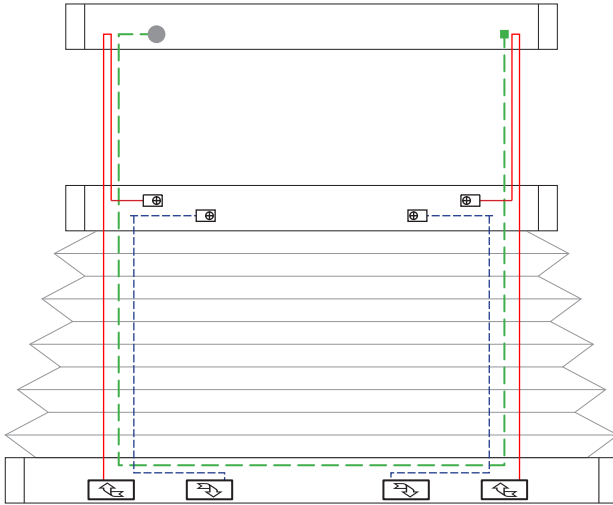

2 Drahtbohrungen/Wire boreholes/Passages de fil

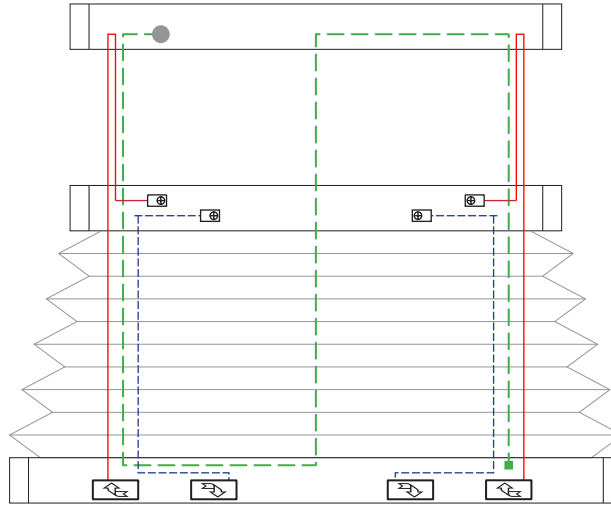

3 Drahtbohrungen/Wire boreholes/Passages de fil

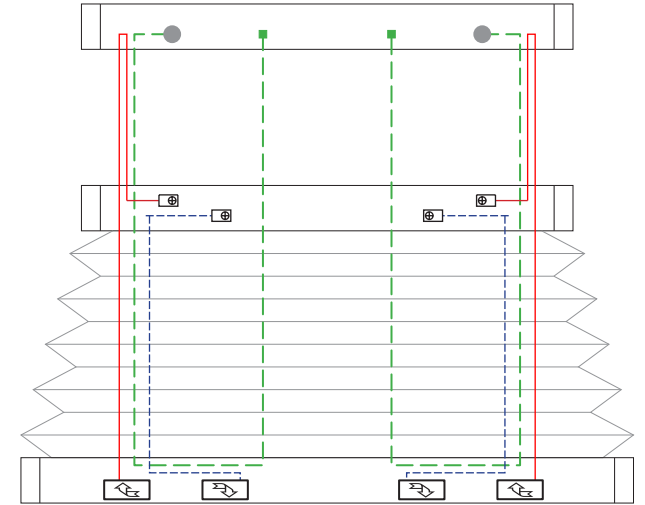

4 Drahtbohrungen/Wire boreholes/Passages de fil

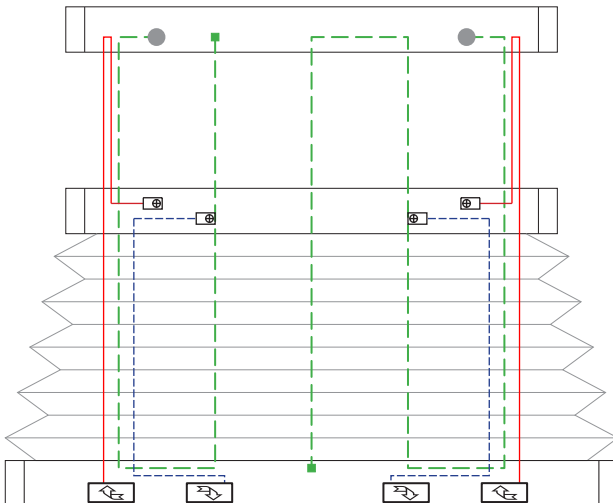

5 Drahtbohrungen/Wire boreholes/Passages de fil

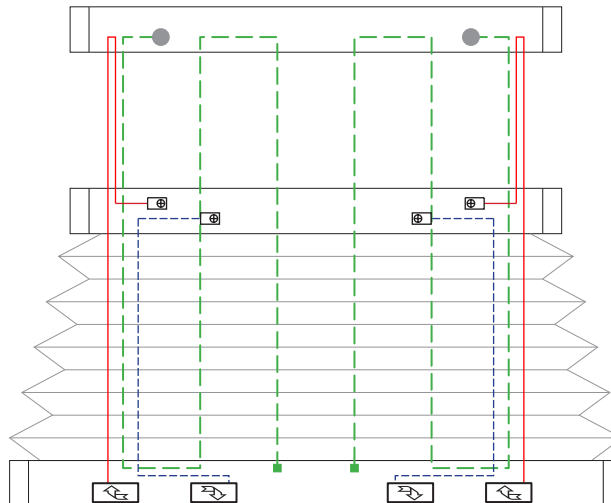

6 Drahtbohrungen/Wire boreholes/Passages de fil



P 3830-3

- 1. Wickelschnur/Winding cord/Cordon d'enroulement Ø1,2 mm
- - - 2. Wickelschnur/Winding cord/Cordon d'enroulement Ø1,2 mm
- - - Gummiband/Rubber band/Ruban en caoutchouc Ø1,25 mm
- SOMFY CTS 25 Schnurwickler/Cord winder/Dévidoir de cordon

- - - Spanndraht/Tension wire/Fil de tension Ø0,8 mm
- Drahtspanner/Wire stretcher/Tendeur de fil
- Schnurspanner/Cord stretcher/Tendeur de cordon

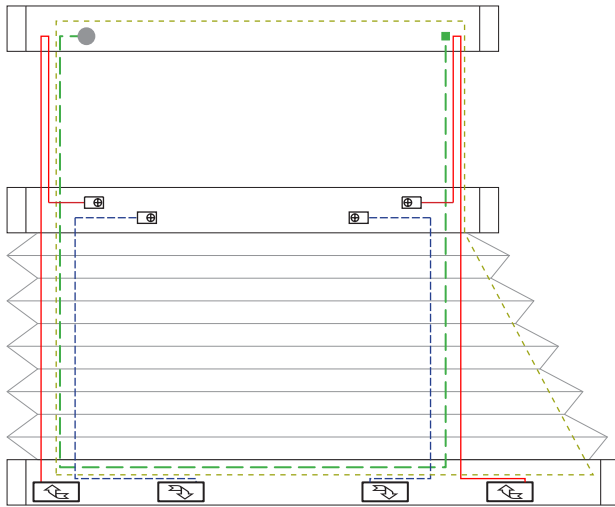

2 Drahtbohrungen/Wire boreholes/Passages de fil

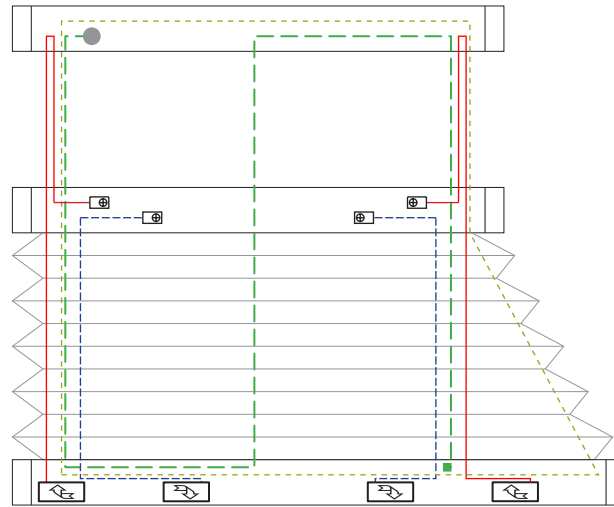

3 Drahtbohrungen/Wire boreholes/Passages de fil

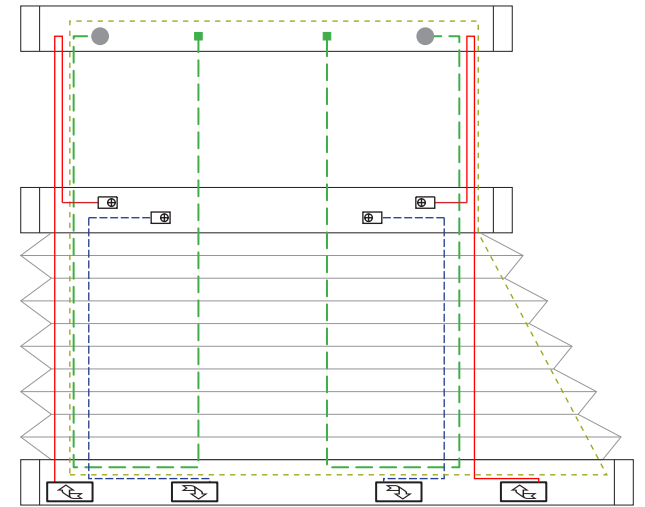

4 Drahtbohrungen/Wire boreholes/Passages de fil

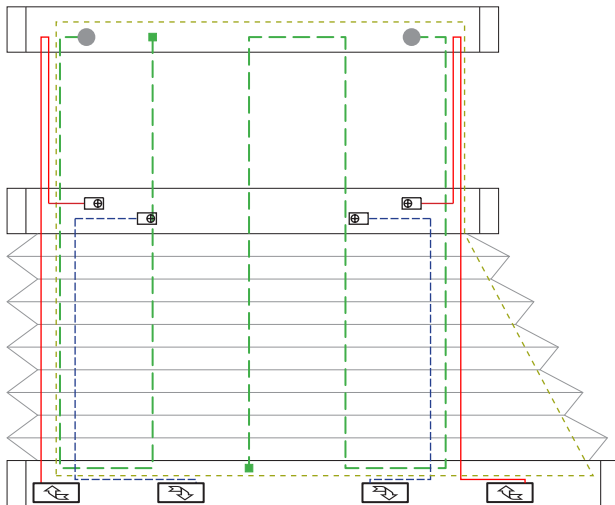

5 Drahtbohrungen/Wire boreholes/Passages de fil

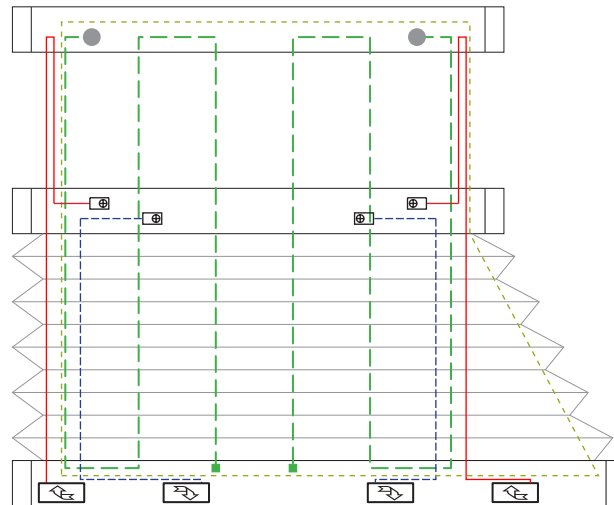

6 Drahtbohrungen/Wire boreholes/Passages de fil



P 3830-4

- 1. Wickelschnur/Winding cord/Cordon d'enroulement Ø1,2 mm
- - - 2. Wickelschnur/Winding cord/Cordon d'enroulement Ø1,2 mm
- - - Gummiband/Rubber band/Ruban en caoutchouc Ø1,25 mm
- SOMFY CTS 25 Schnurwickler/Cord winder/Dévidoir de cordon

- - - Spanndraht/Tension wire/Fil de tension Ø0,8 mm
- Drahtspanner/Wire stretcher/Tendeur de fil
- Schnurspanner/Cord stretcher/Tendeur de cordon

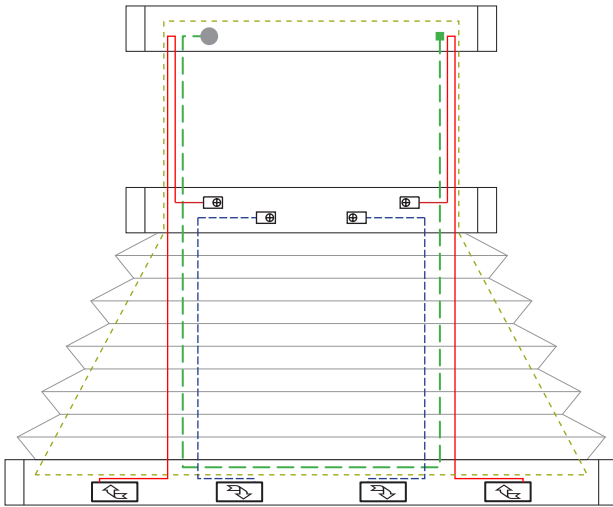

2 Drahtbohrungen/Wire boreholes/Passages de fil

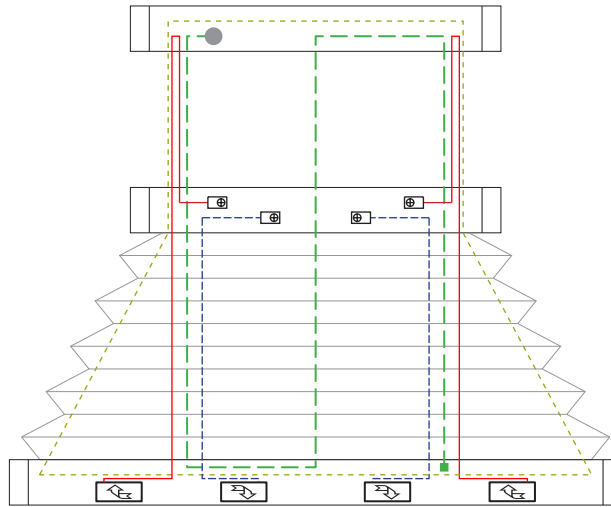

3 Drahtbohrungen/Wire boreholes/Passages de fil

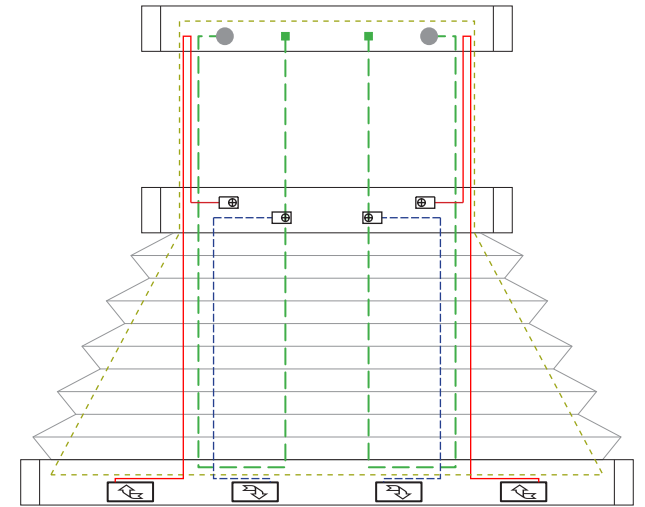

4 Drahtbohrungen/Wire boreholes/Passages de fil

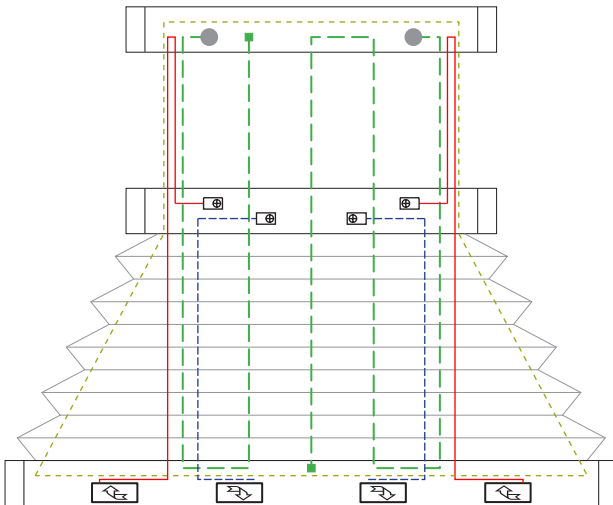



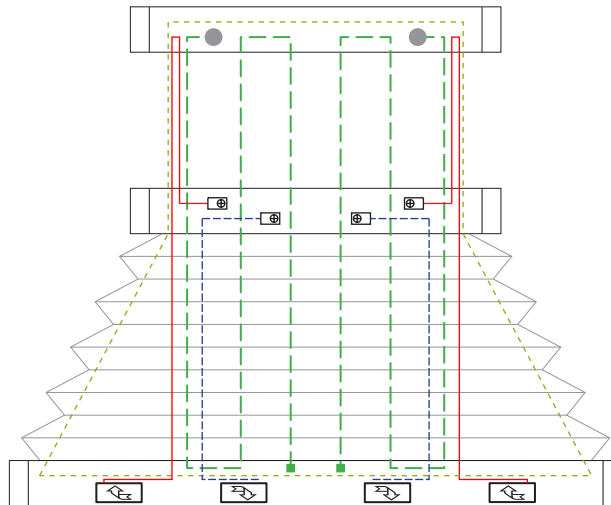

5 Drahtbohrungen/Wire boreholes/Passages de fil





6 Drahtbohrungen/Wire boreholes/Passages de fil



P 3834-1

-  1. Wickelschnur/Winding cord/Cordon d'enroulement Ø1,2 mm
-  2. Wickelschnur/Winding cord/Cordon d'enroulement Ø1,2 mm
-  Gummiband/Rubber band/Ruban en caoutchouc Ø1,25 mm
-  SOMFY CTS 25 Schnurwickler/Cord winder/Dévidoir de cordon

-  Spanndraht/Tension wire/Fil de tension Ø0,8 mm
-  Drahtspanner/Wire stretcher/Tendeur de fil

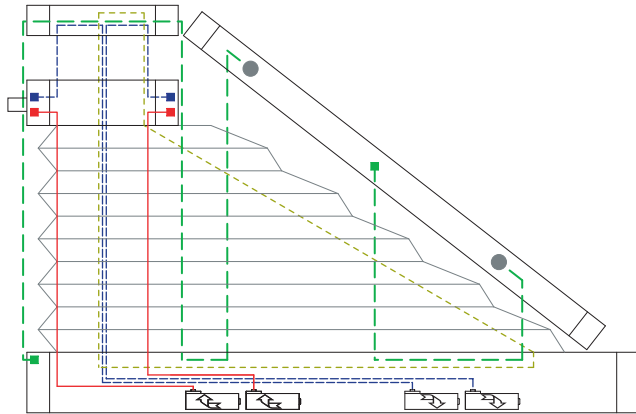

4 Drahtbohrungen/Wire boreholes/Passages de fil

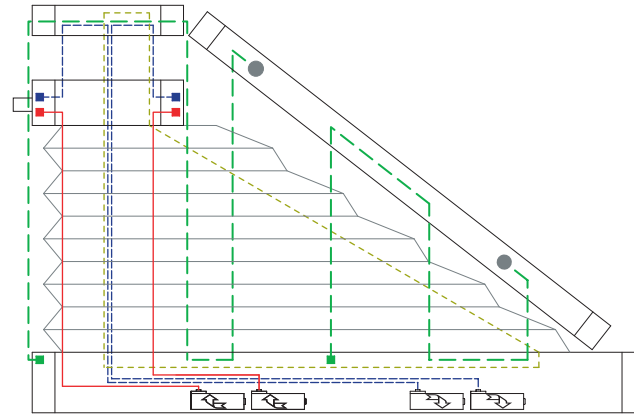



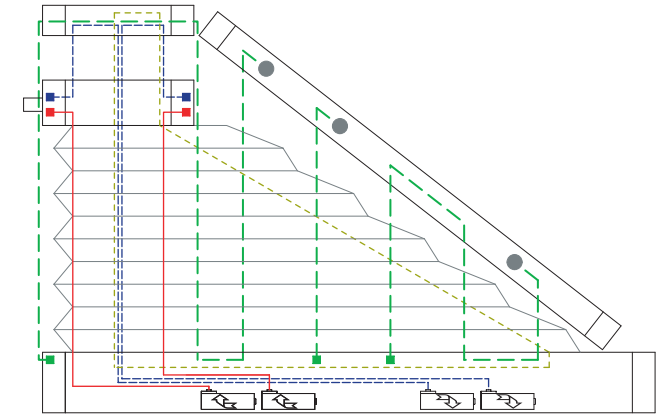

5 Drahtbohrungen/Wire boreholes/Passages de fil





6 Drahtbohrungen/Wire boreholes/Passages de fil



P 3834-2

-  1. Wickelschnur/Winding cord/Cordon d'enroulement Ø1,2 mm
-  2. Wickelschnur/Winding cord/Cordon d'enroulement Ø1,2 mm
-  Gummiband/Rubber band/Ruban en caoutchouc Ø1,25 mm
-  SOMFY CTS 25 Schnurwickler/Cord winder/Dévidoir de cordon

-  Spanndraht/Tension wire/Fil de tension Ø0,8 mm
-  Drahtspanner/Wire stretcher/Tendeur de fil
-  Schnurspanner/Cord stretcher/Tendeur de cordon

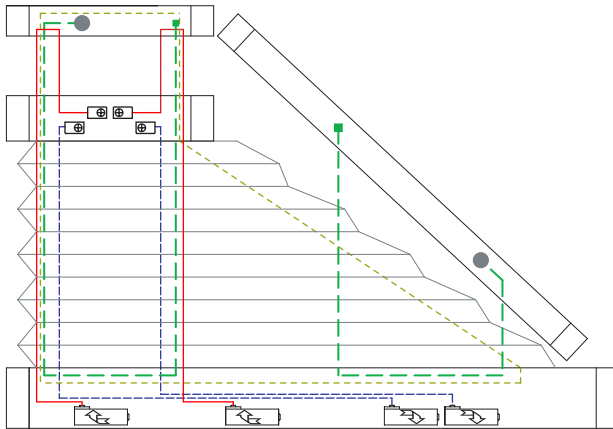

4 Drahtbohrungen/Wire boreholes/Passages de fil

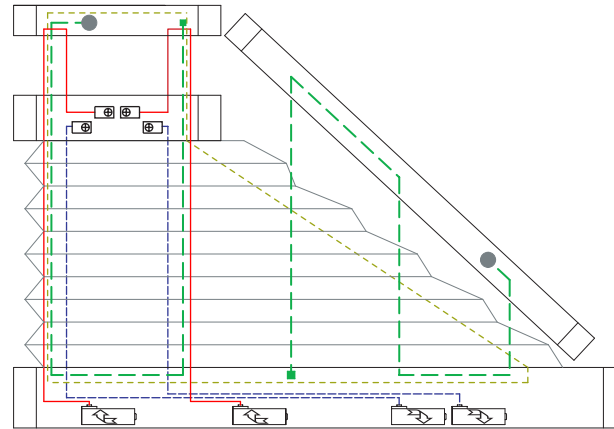



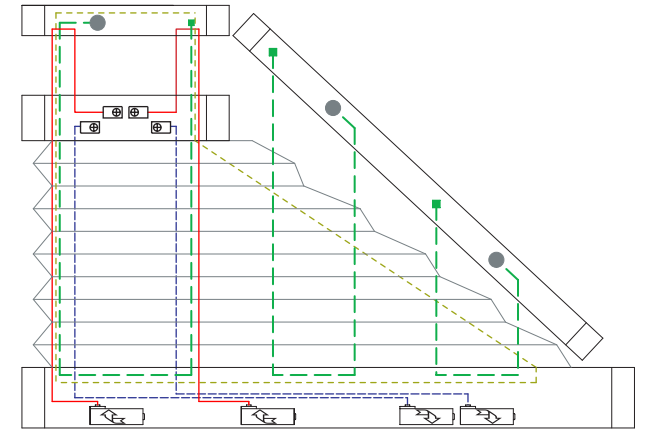

5 Drahtbohrungen/Wire boreholes/Passages de fil





6 Drahtbohrungen/Wire boreholes/Passages de fil



P 3834-3

-  1. Wickelschnur/Winding cord/Cordon d'enroulement Ø1,2 mm
-  2. Wickelschnur/Winding cord/Cordon d'enroulement Ø1,2 mm
-  Gummiband/Rubber band/Ruban en caoutchouc Ø1,25 mm
-  SOMFY CTS 25 Schnurwickler/Cord winder/Dévidoir de cordon

-  Spanndraht/Tension wire/Fil de tension Ø0,8 mm
-  Drahtspanner/Wire stretcher/Tendeur de fil
-  Schnurspanner/Cord stretcher/Tendeur de cordon

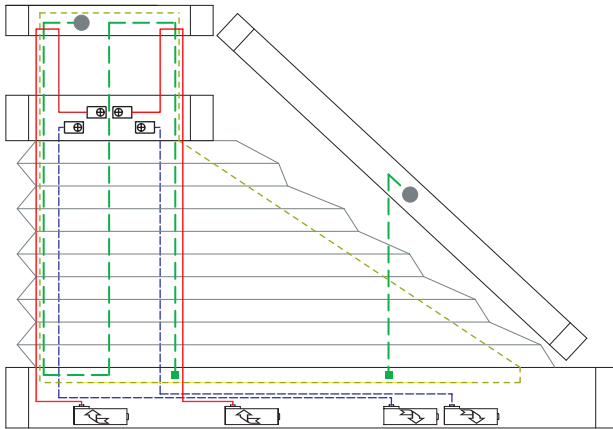

4 Drahtbohrungen/Wire boreholes/Passages de fil

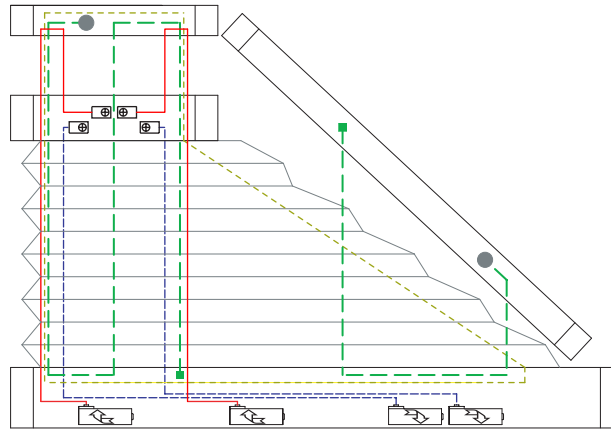



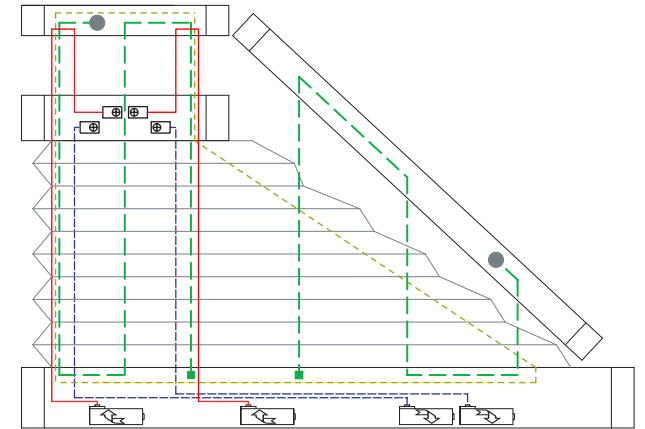

5 Drahtbohrungen/Wire boreholes/Passages de fil





6 Drahtbohrungen/Wire boreholes/Passages de fil



P 3834-4

-  1. Wickelschnur/Winding cord/Cordon d'enroulement Ø1,2 mm
-  2. Wickelschnur/Winding cord/Cordon d'enroulement Ø1,2 mm
-  Gummiband/Rubber band/Ruban en caoutchouc Ø1,25 mm
-  SOMFY CTS 25 Schnurwickler/Cord winder/Dévidoir de cordon

-  Spanndraht/Tension wire/Fil de tension Ø0,8 mm
-  Drahtspanner/Wire stretcher/Tendeur de fil
-  Schnurspanner/Cord stretcher/Tendeur de cordon

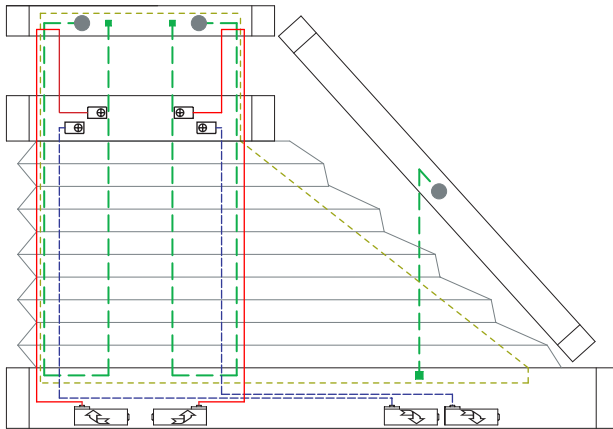



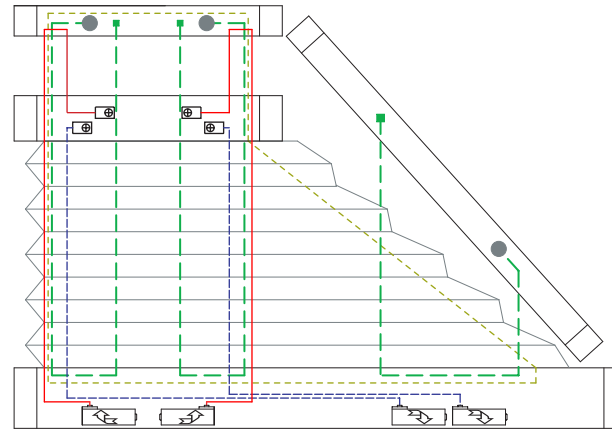

5 Drahtbohrungen/Wire boreholes/Passages de fil





6 Drahtbohrungen/Wire boreholes/Passages de fil



P 3834-5

-  1. Wickelschnur/Winding cord/Cordon d'enroulement Ø1,2 mm
-  2. Wickelschnur/Winding cord/Cordon d'enroulement Ø1,2 mm
-  Gummiband/Rubber band/Ruban en caoutchouc Ø1,25 mm
-  SOMFY CTS 25 Schnurwickler/Cord winder/Dévidoir de cordon



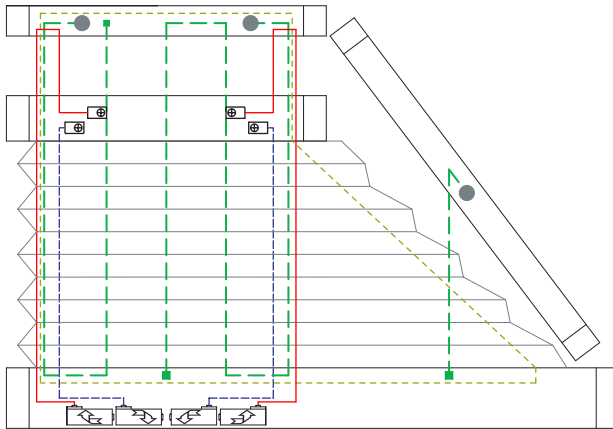

-  Spanndraht/Tension wire/Fil de tension Ø0,8 mm
-  Drahtspanner/Wire stretcher/Tendeur de fil
-  Schnurspanner/Cord stretcher/Tendeur de cordon





6 Drahtbohrungen/Wire boreholes/Passages de fil



P 3834-6

-  1. Wickelschnur/Winding cord/Cordon d'enroulement Ø1,2 mm
-  2. Wickelschnur/Winding cord/Cordon d'enroulement Ø1,2 mm
-  Gummiband/Rubber band/Ruban en caoutchouc Ø1,25 mm
-  SOMFY CTS 25 Schnurwickler/Cord winder/Dévidoir de cordon



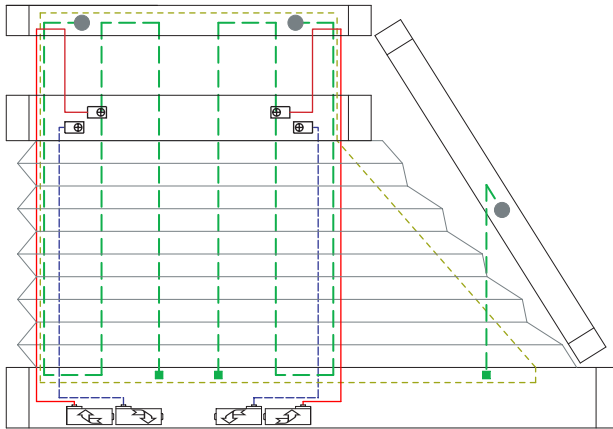

-  Spanndraht/Tension wire/Fil de tension Ø0,8 mm
-  Drahtspanner/Wire stretcher/Tendeur de fil
-  Schnurspanner/Cord stretcher/Tendeur de cordon





7 Drahtbohrungen/Wire boreholes/Passages de fil



P 3835-2

-  1. Wickelschnur/Winding cord/Cordon d'enroulement Ø1,2 mm
-  2. Wickelschnur/Winding cord/Cordon d'enroulement Ø1,2 mm
-  Gummiband/Rubber band/Ruban en caoutchouc Ø1,25 mm
-  SOMFY CTS 25 Schnurwickler/Cord winder/Dévidoir de cordon

-  Spanndraht/Tension wire/Fil de tension Ø0,8 mm
-  Drahtspanner/Wire stretcher/Tendeur de fil
-  Schnurspanner/Cord stretcher/Tendeur de cordon

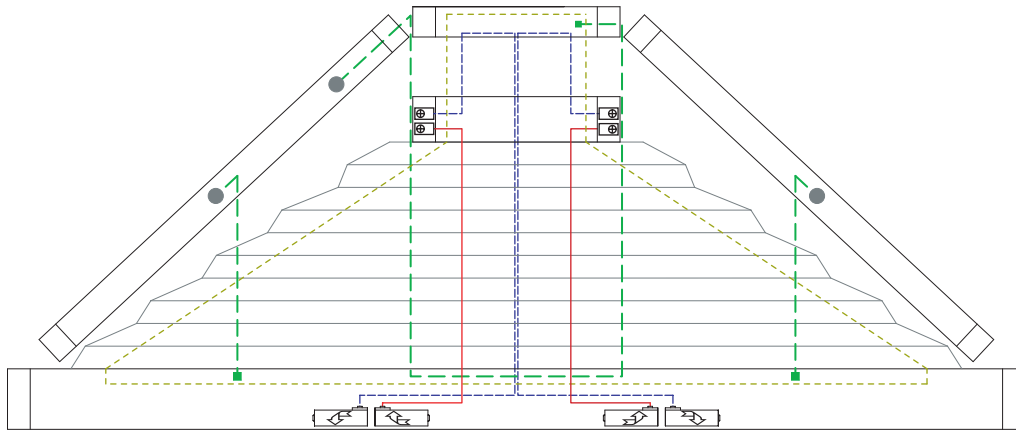

4 Drahtbohrungen/Wire boreholes/Passages de fil

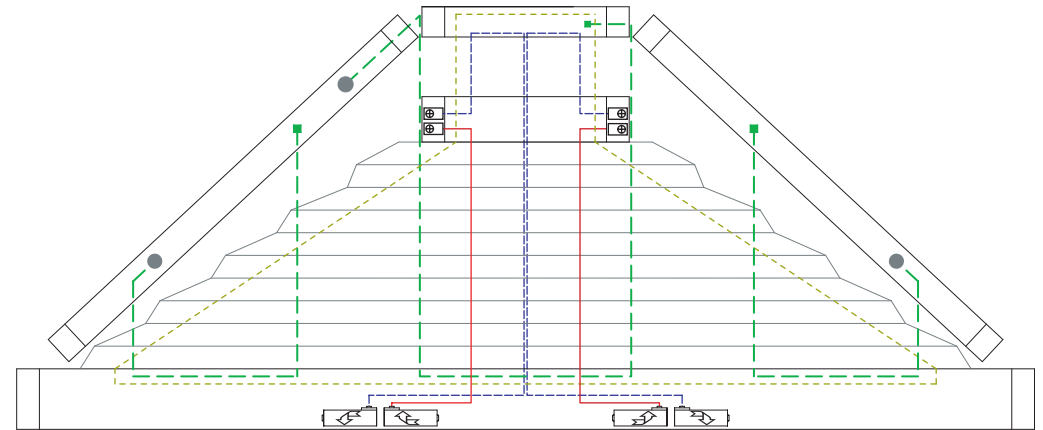

6 Drahtbohrungen/Wire boreholes/Passages de fil

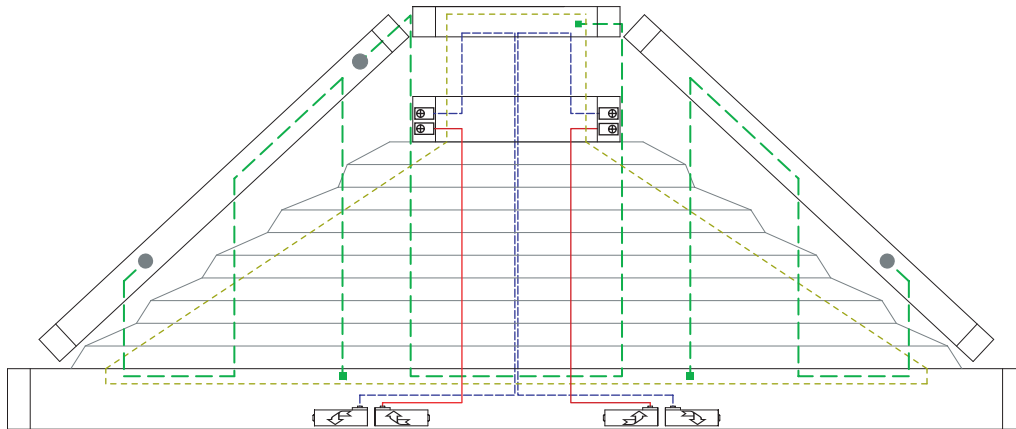

8 Drahtbohrungen/Wire boreholes/Passages de fil



P 3835-3

- 1. Wickelschnur/Winding cord/Cordon d'enroulement Ø1,2 mm
- - - 2. Wickelschnur/Winding cord/Cordon d'enroulement Ø1,2 mm
- - - Gummiband/Rubber band/Ruban en caoutchouc Ø1,25 mm
- SOMFY CTS 25 Schnurwickler/Cord winder/Dévidoir de cordon

- - - Spanndraht/Tension wire/Fil de tension Ø0,8 mm
- Drahtspanner/Wire stretcher/Tendeur de fil
- Schnurspanner/Cord stretcher/Tendeur de cordon

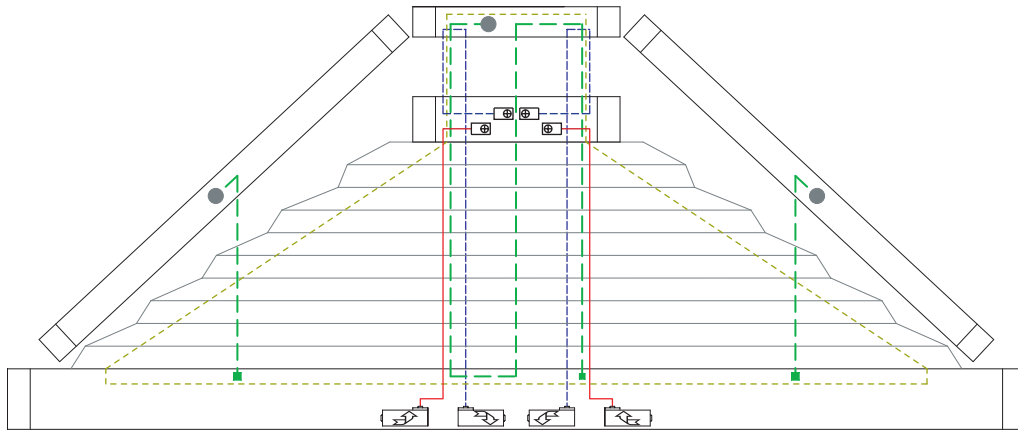

5 Drahtbohrungen/Wire boreholes/Passages de fil

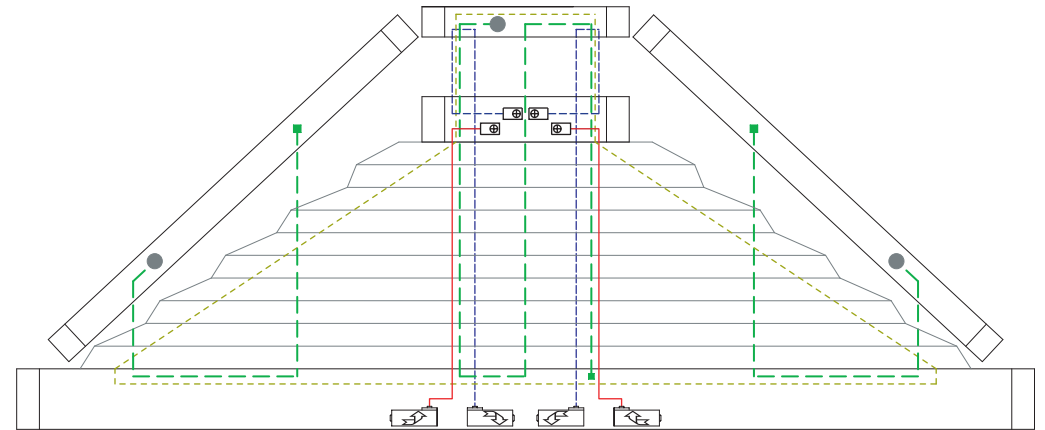



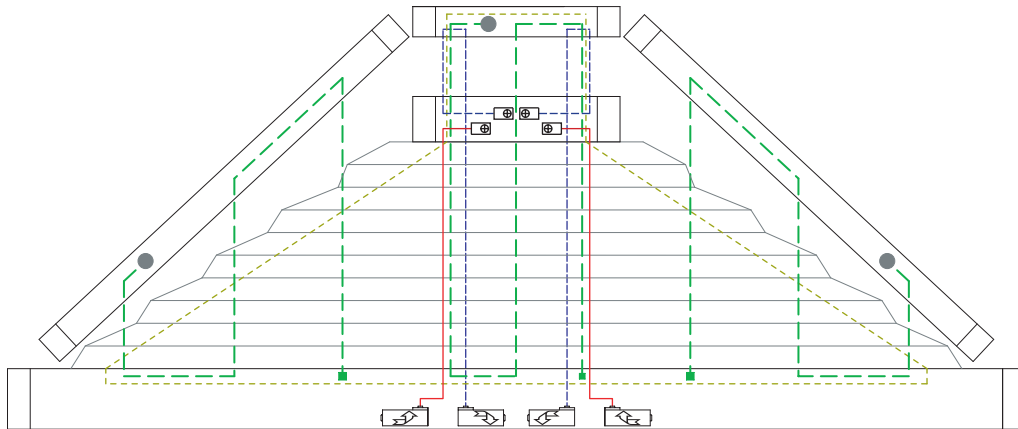

7 Drahtbohrungen/Wire boreholes/Passages de fil





9 Drahtbohrungen/Wire boreholes/Passages de fil



P 3835-4

-  1. Wickelschnur/Winding cord/Cordon d'enroulement Ø1,2 mm
-  2. Wickelschnur/Winding cord/Cordon d'enroulement Ø1,2 mm
-  Gummiband/Rubber band/Ruban en caoutchouc Ø1,25 mm
-  SOMFY CTS 25 Schnurwickler/Cord winder/Dévidoir de cordon

-  Spanndraht/Tension wire/Fil de tension Ø0,8 mm
-  Drahtspanner/Wire stretcher/Tendeur de fil
-  Schnurspanner/Cord stretcher/Tendeur de cordon

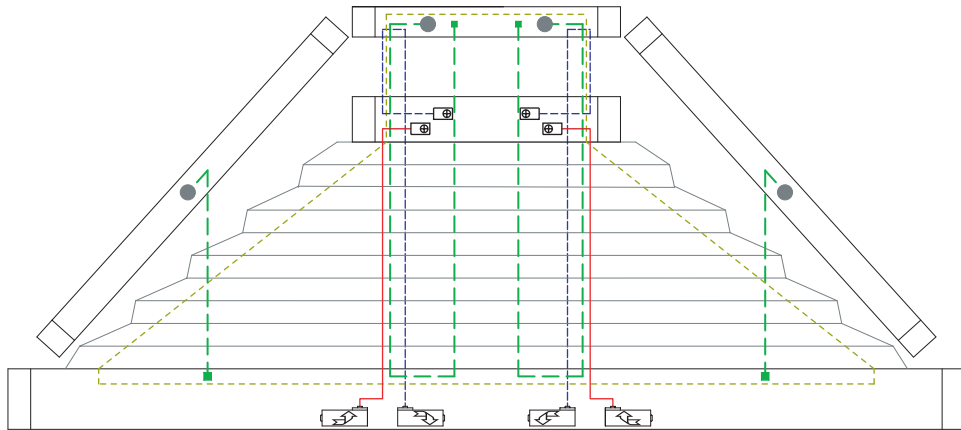



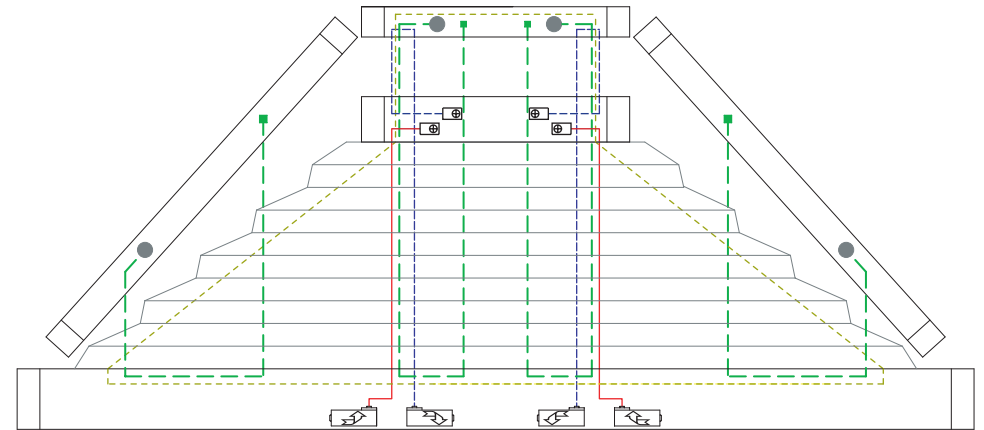

6 Drahtbohrungen/Wire boreholes/Passages de fil





8 Drahtbohrungen/Wire boreholes/Passages de fil



P 3835-5

-  1. Wickelschnur/Winding cord/Cordon d'enroulement Ø1,2 mm
-  2. Wickelschnur/Winding cord/Cordon d'enroulement Ø1,2 mm
-  Gummiband/Rubber band/Ruban en caoutchouc Ø1,25 mm
-  SOMFY CTS 25 Schnurwickler/Cord winder/Dévidoir de cordon

-  Spanndraht/Tension wire/Fil de tension Ø0,8 mm
-  Drahtspanner/Wire stretcher/Tendeur de fil
-  Schnurspanner/Cord stretcher/Tendeur de cordon

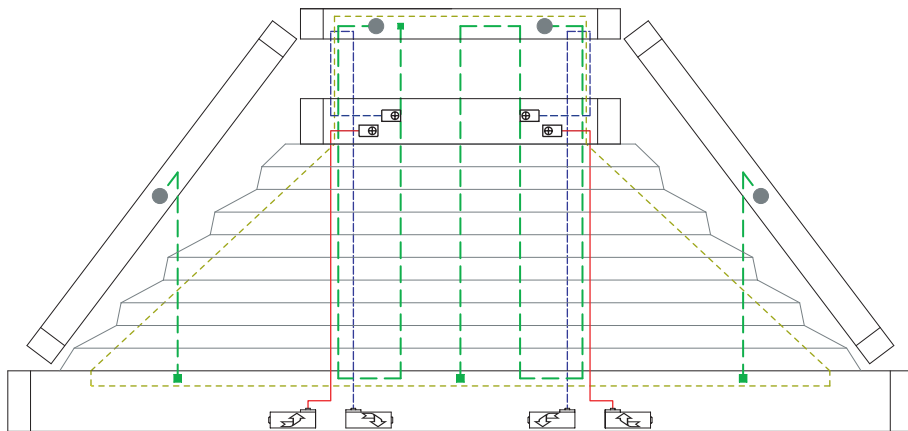

7 Drahtbohrungen/Wire boreholes/Passages de fil

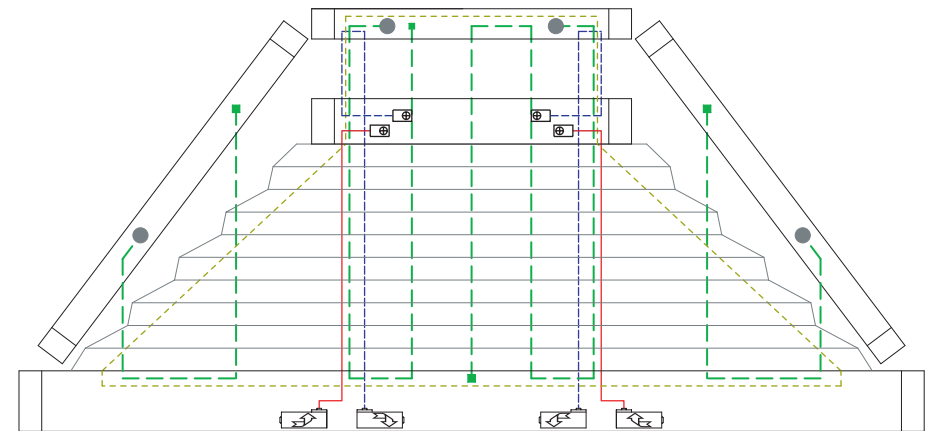

9 Drahtbohrungen/Wire boreholes/Passages de fil



P 3835-6

- 1. Wickelschnur/Winding cord/Cordon d'enroulement Ø1,2 mm
- 2. Wickelschnur/Winding cord/Cordon d'enroulement Ø1,2 mm
- Gummiband/Rubber band/Ruban en caoutchouc Ø1,25 mm
- SOMFY CTS 25 Schnurwickler/Cord winder/Dévidoir de cordon



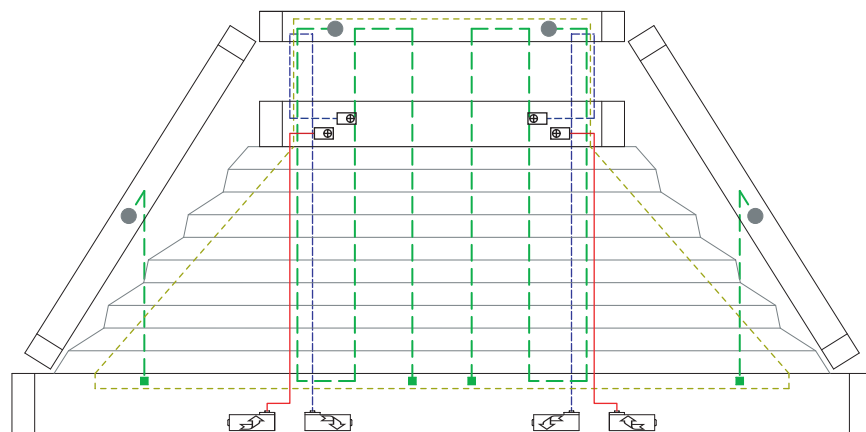

- Spanndraht/Tension wire/Fil de tension Ø0,8 mm
- Drahtspanner/Wire stretcher/Tendeur de fil
- Schnurspanner/Cord stretcher/Tendeur de cordon





8 Drahtbohrungen/Wire boreholes/Passages de fil



P 3836

-  1. Wickelschnur/Winding cord/Cordon d'enroulement Ø1,2 mm
-  2. Wickelschnur/Winding cord/Cordon d'enroulement Ø1,2 mm
-  Gummiband/Rubber band/Ruban en caoutchouc Ø1,25 mm
-  SOMFY CTS 25 Schnurwickler/Cord winder/Dévidoir de cordon

-  Spanndraht/Tension wire/Fil de tension Ø0,8 mm
-  Drahtspanner/Wire stretcher/Tendeur de fil

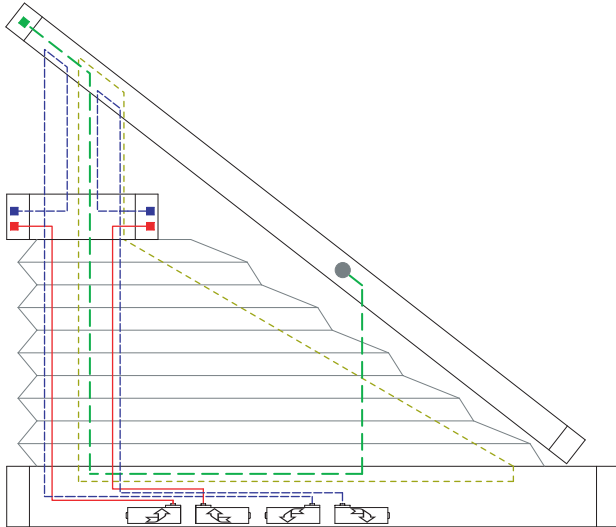

2 Drahtbohrungen/Wire boreholes/Passages de fil

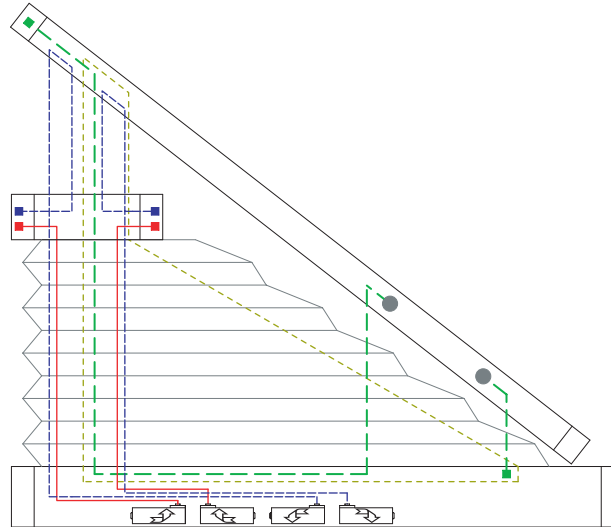

3 Drahtbohrungen/Wire boreholes/Passages de fil

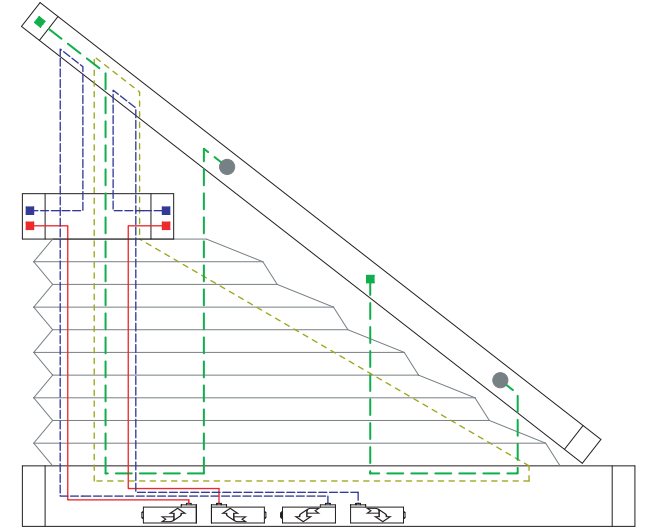

4 Drahtbohrungen/Wire boreholes/Passages de fil

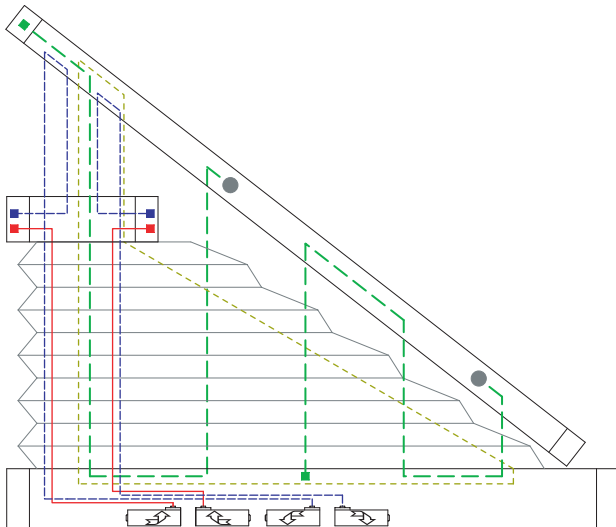



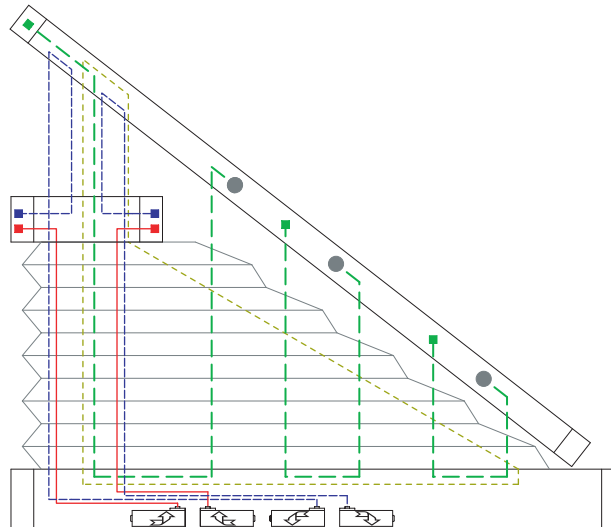

5 Drahtbohrungen/Wire boreholes/Passages de fil





6 Drahtbohrungen/Wire boreholes/Passages de fil



P 3837

-  1. Wickelschnur/Winding cord/Cordon d'enroulement Ø1,2 mm
-  2. Wickelschnur/Winding cord/Cordon d'enroulement Ø1,2 mm
-  Gummiband/Rubber band/Ruban en caoutchouc Ø1,25 mm
-  SOMFY CTS 25 Schnurwickler/Cord winder/Dévidoir de cordon

-  Spanndraht/Tension wire/Fil de tension Ø0,8 mm
-  Drahtspanner/Wire stretcher/Tendeur de fil

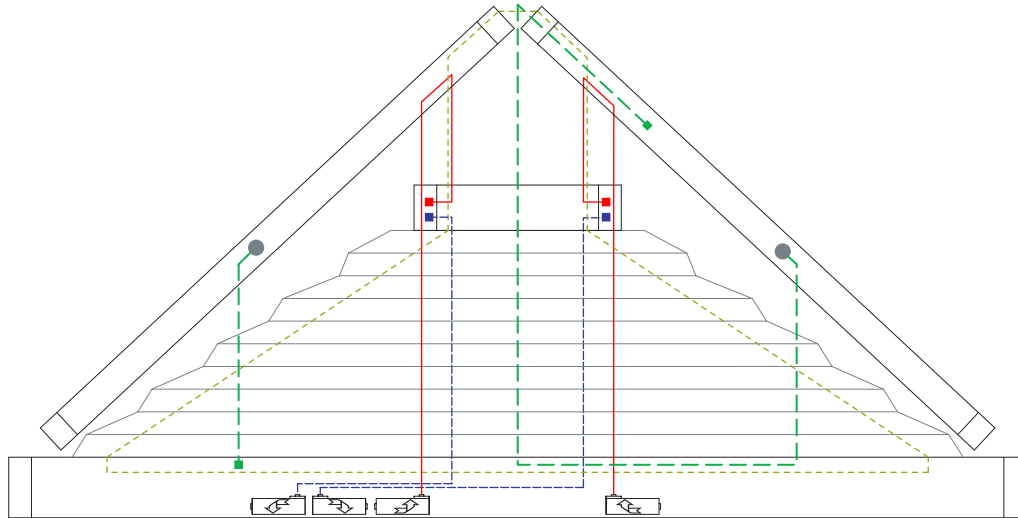

3 Drahtbohrungen/Wire boreholes/Passages de fil

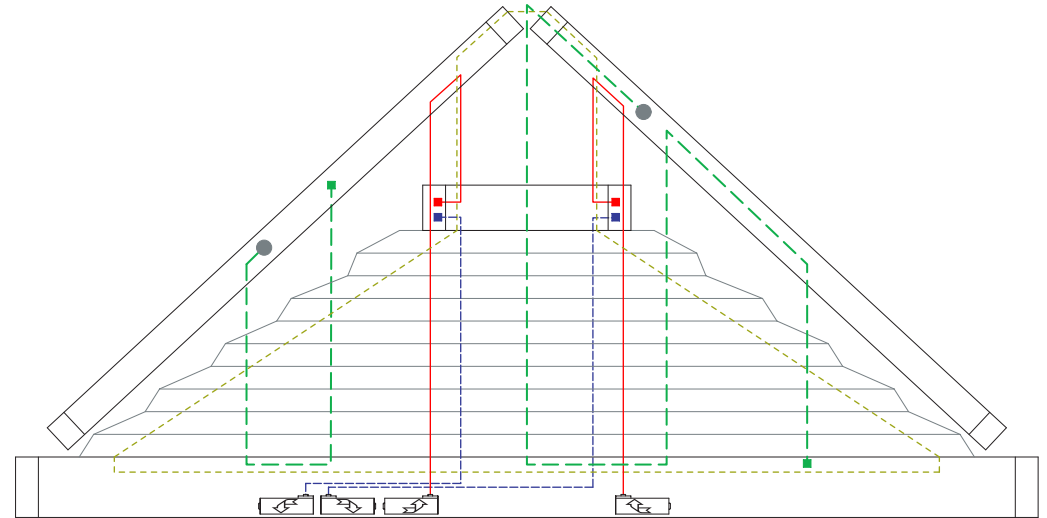

5 Drahtbohrungen/Wire boreholes/Passages de fil

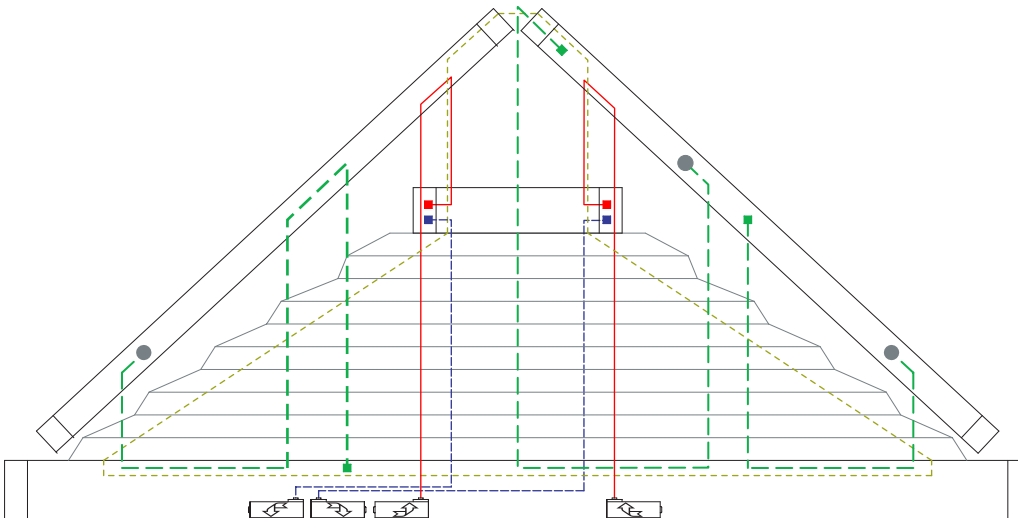

7 Drahtbohrungen/Wire boreholes/Passages de fil



P 3862-1

- 1. Wickelschnur/Winding cord/Cordon d'enroulement Ø1,2 mm
- - - 2. Wickelschnur/Winding cord/Cordon d'enroulement Ø1,2 mm
- - - Spanndraht/Tension wire/Fil de tension Ø0,8 mm
- SOMFY CTS 25 Schnurwickler/Cord winder/Dévidoir de cordon

- Drahtspanner/Wire stretcher/Tendeur de fil

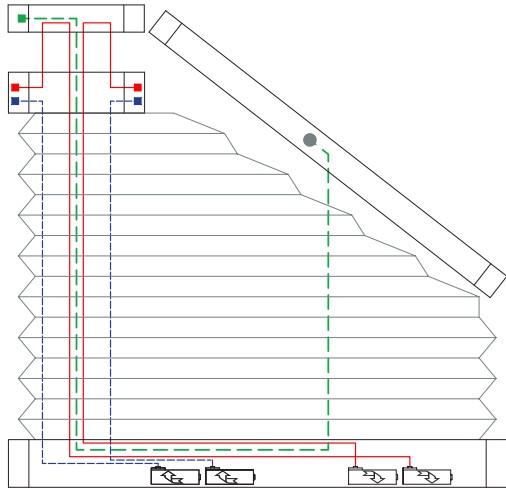

2 Drahtbohrungen/Wire boreholes/Passages de fil



3 Drahtbohrungen/Wire boreholes/Passages de fil

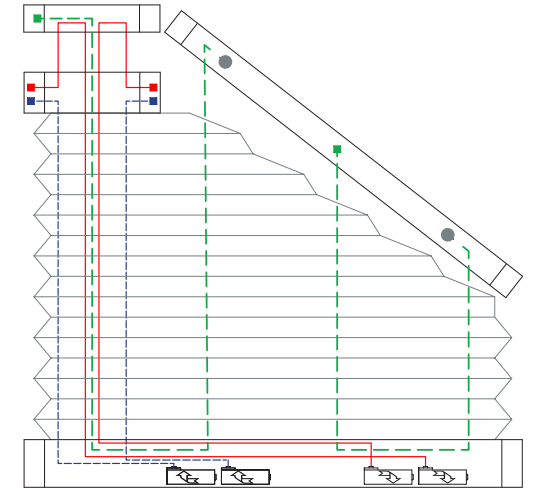

4 Drahtbohrungen/Wire boreholes/Passages de fil

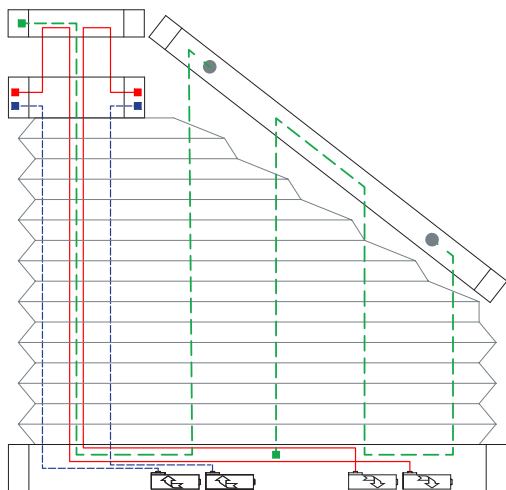

5 Drahtbohrungen/Wire boreholes/Passages de fil

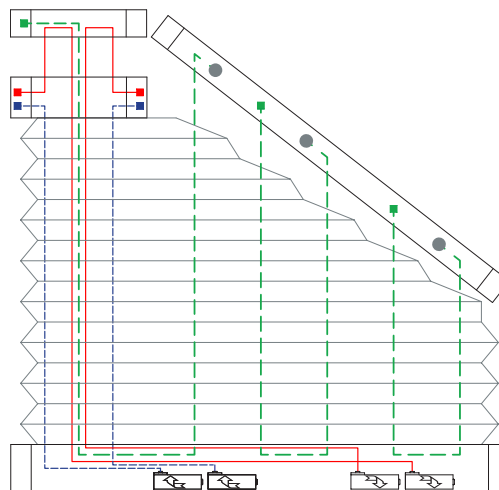

6 Drahtbohrungen/Wire boreholes/Passages de fil

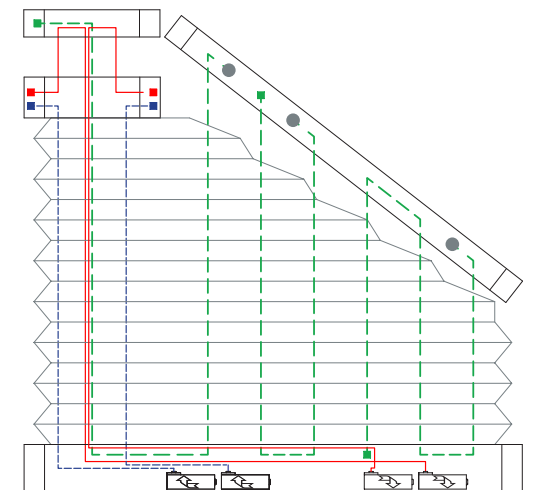

7 Drahtbohrungen/Wire boreholes/Passages de fil



P 3862-2

- 1. Wickelschnur/Winding cord/Cordon d'enroulement Ø1,2 mm
- - - 2. Wickelschnur/Winding cord/Cordon d'enroulement Ø1,2 mm
- - - Spanndraht/Tension wire/Fil de tension Ø0,8 mm
- SOMFY CTS 25 Schnurwickler/Cord winder/Dévidoir de cordon

- Drahtspanner/Wire stretcher/Tendeur de fil
- ⊗ Schnurspanner/Cord stretcher/Tendeur de cordon

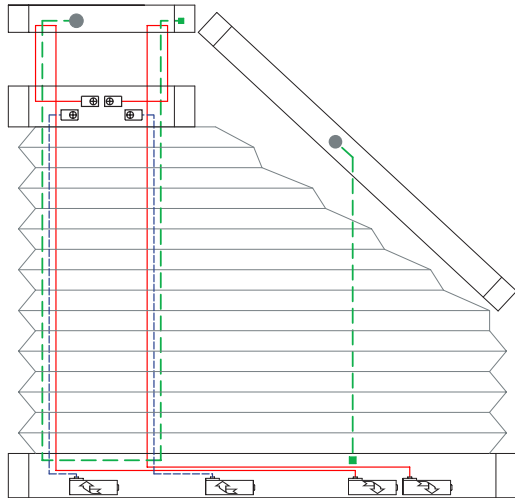

3 Drahtbohrungen/Wire boreholes/Passages de fil

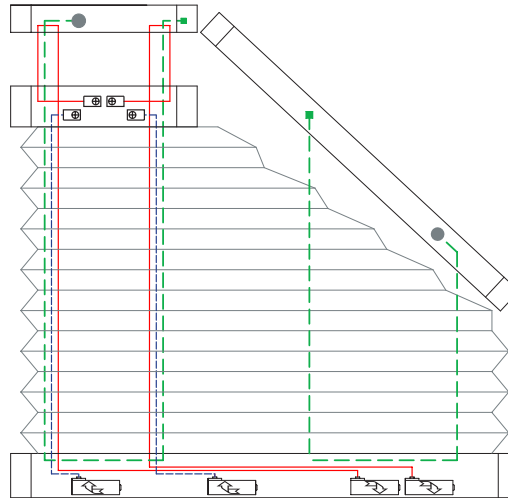

4 Drahtbohrungen/Wire boreholes/Passages de fil

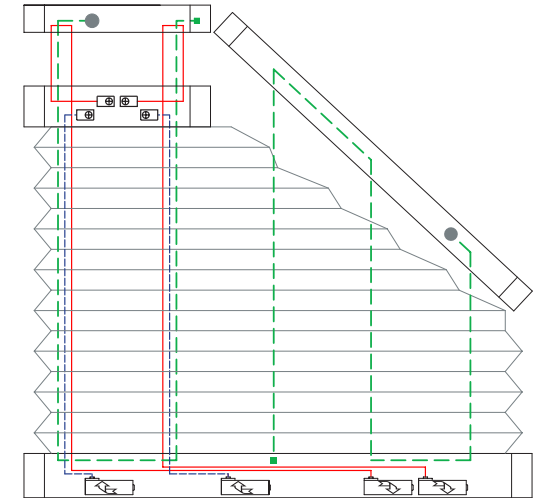

5 Drahtbohrungen/Wire boreholes/Passages de fil

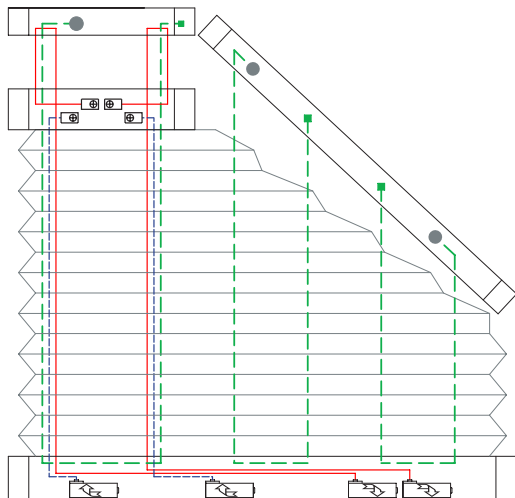

6 Drahtbohrungen/Wire boreholes/Passages de fil

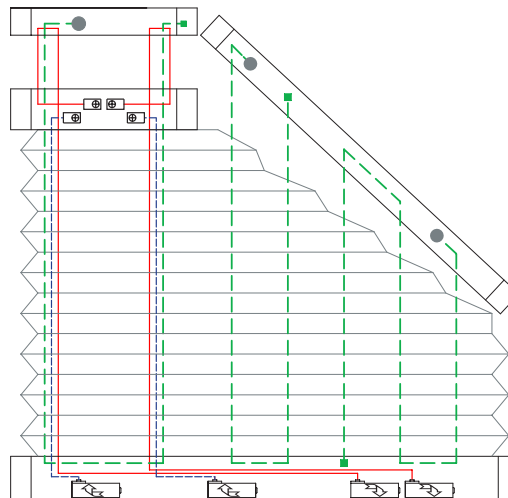

7 Drahtbohrungen/Wire boreholes/Passages de fil



P 3862-3

- 1. Wickelschnur/Winding cord/Cordon d'enroulement Ø1,2 mm
- - - 2. Wickelschnur/Winding cord/Cordon d'enroulement Ø1,2 mm
- - - Spanndraht/Tension wire/Fil de tension Ø0,8 mm
- SOMFY CTS 25 Schnurwickler/Cord winder/Dévidoir de cordon

- Drahtspanner/Wire stretcher/Tendeur de fil
- Schnurspanner/Cord stretcher/Tendeur de cordon

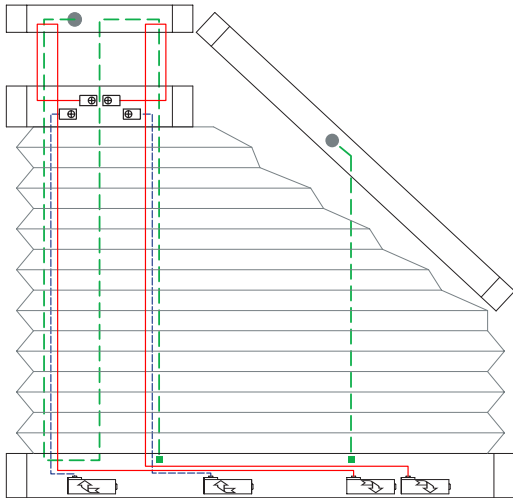

4 Drahtbohrungen/Wire boreholes/Passages de fil

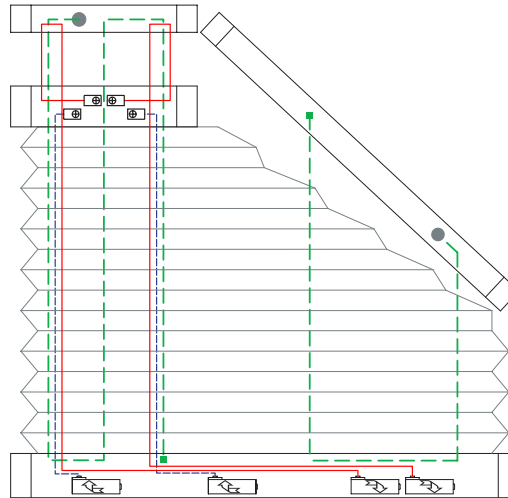

5 Drahtbohrungen/Wire boreholes/Passages de fil

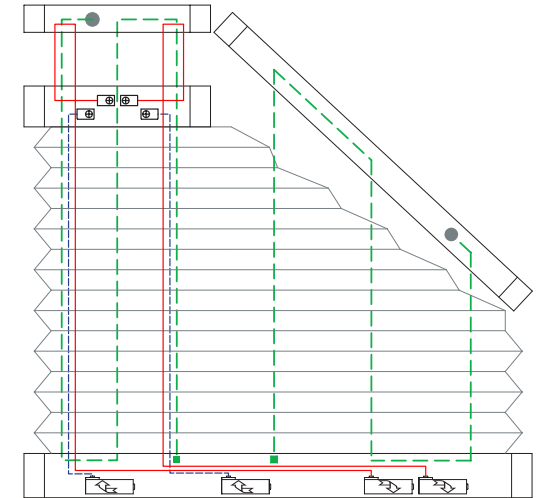

6 Drahtbohrungen/Wire boreholes/Passages de fil

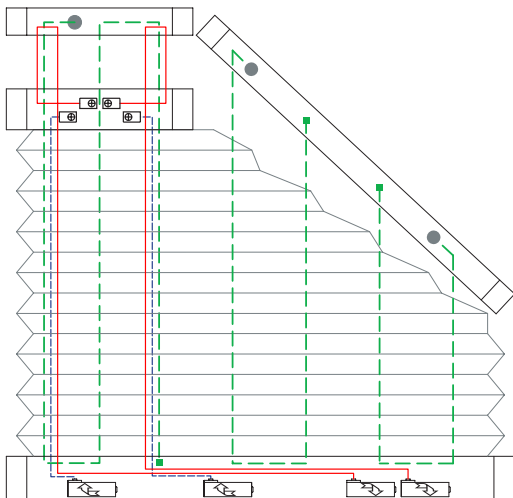

7 Drahtbohrungen/Wire boreholes/Passages de fil



P 3862-4

- 1. Wickelschnur/Winding cord/Cordon d'enroulement Ø1,2 mm
- - - 2. Wickelschnur/Winding cord/Cordon d'enroulement Ø1,2 mm
- - - Spanndraht/Tension wire/Fil de tension Ø0,8 mm
- SOMFY CTS 25 Schnurwickler/Cord winder/Dévidoir de cordon

- Drahtspanner/Wire stretcher/Tendeur de fil
- Schnurspanner/Cord stretcher/Tendeur de cordon

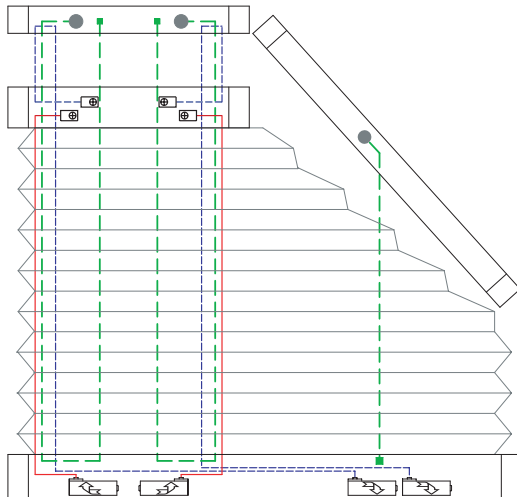

5 Drahtbohrungen/Wire boreholes/Passages de fil

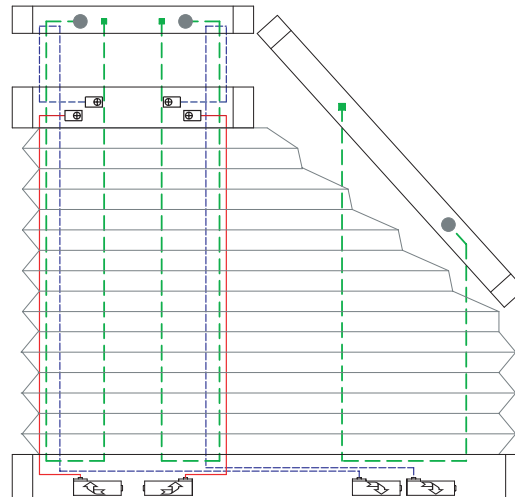



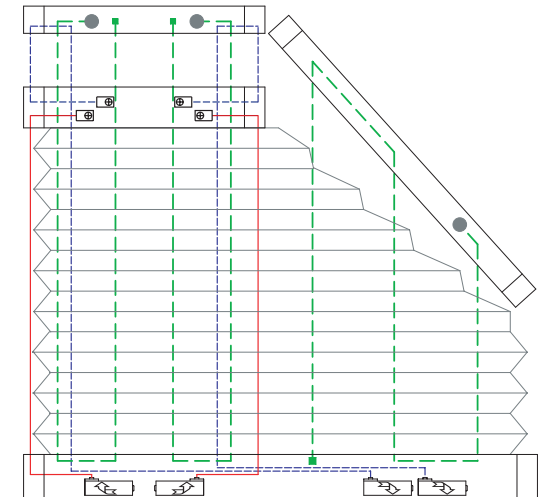

6 Drahtbohrungen/Wire boreholes/Passages de fil





7 Drahtbohrungen/Wire boreholes/Passages de fil



P 3862-5

-  1. Wickelschnur/Winding cord/Cordon d'enroulement Ø1,2 mm
-  2. Wickelschnur/Winding cord/Cordon d'enroulement Ø1,2 mm
-  Spanndraht/Tension wire/Fil de tension Ø0,8 mm
-  SOMFY CTS 25 Schnurwickler/Cord winder/Dévidoir de cordon

-  Drahtspanner/Wire stretcher/Tendeur de fil
-  Schnurspanner/Cord stretcher/Tendeur de cordon

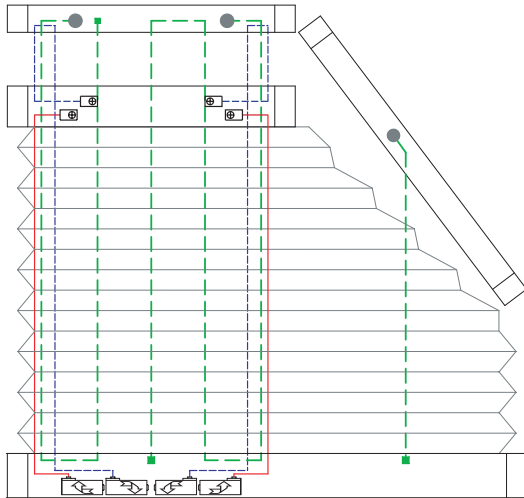



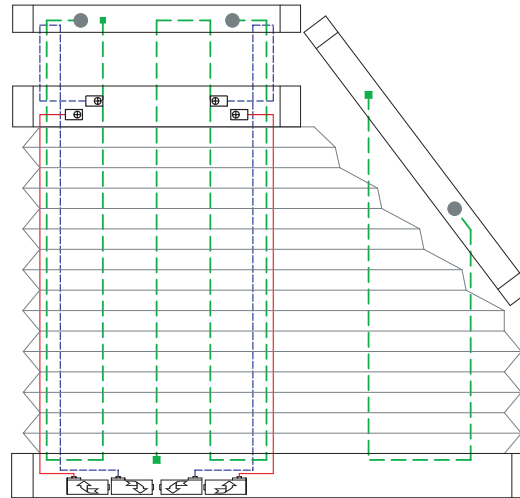

6 Drahtbohrungen/Wire boreholes/Passages de fil





7 Drahtbohrungen/Wire boreholes/Passages de fil



P 3862-6

-  1. Wickelschnur/Winding cord/Cordon d'enroulement Ø1,2 mm
-  2. Wickelschnur/Winding cord/Cordon d'enroulement Ø1,2 mm
-  Spanndraht/Tension wire/Fil de tension Ø0,8 mm
-  SOMFY CTS 25 Schnurwickler/Cord winder/Dévidoir de cordon



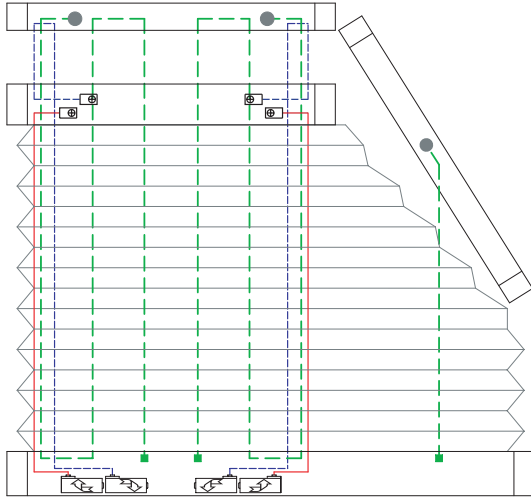

-  Drahtspanner/Wire stretcher/Tendeur de fil
-  Schnurspanner/Cord stretcher/Tendeur de cordon





7 Drahtbohrungen/Wire boreholes/Passages de fil



P 3863-1

-  1. Wickelschnur/Winding cord/Cordon d'enroulement Ø1,2 mm
-  2. Wickelschnur/Winding cord/Cordon d'enroulement Ø1,2 mm
-  Spanndraht/Tension wire/Fil de tension Ø0,8 mm
-  SOMFY CTS 25 Schnurwickler/Cord winder/Dévidoir de cordon

-  Drahtspanner/Wire stretcher/Tendeur de fil
-  Schnurspanner/Cord stretcher/Tendeur de cordon

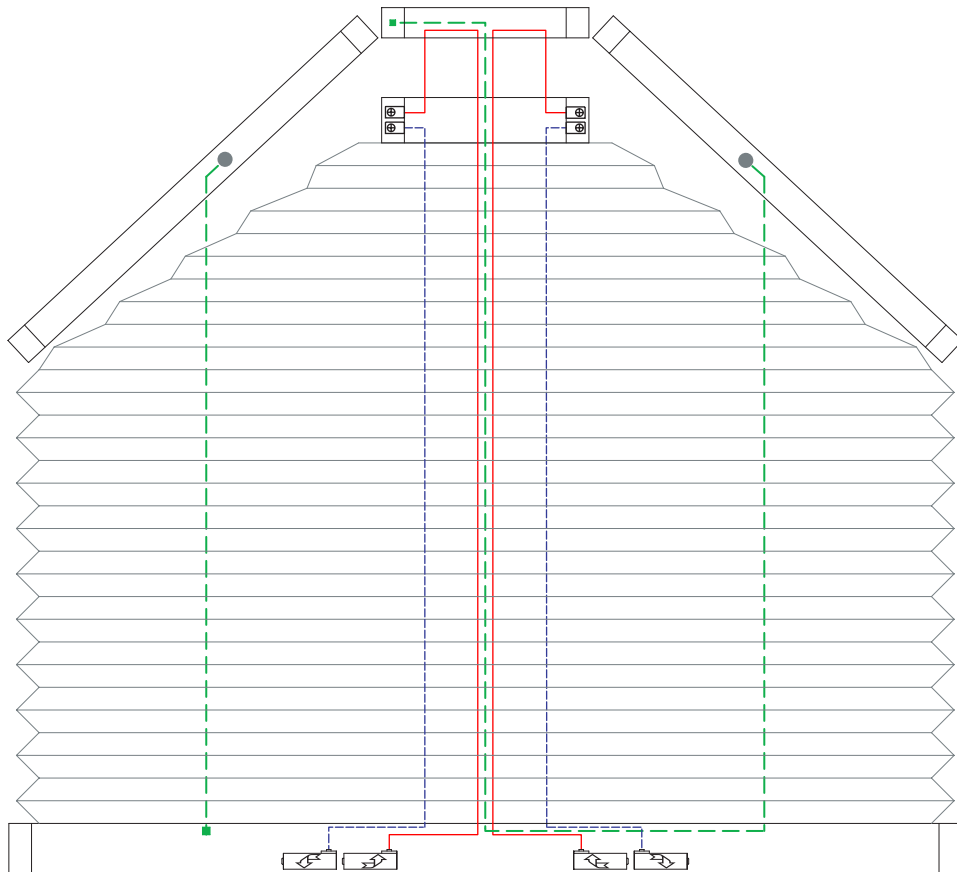



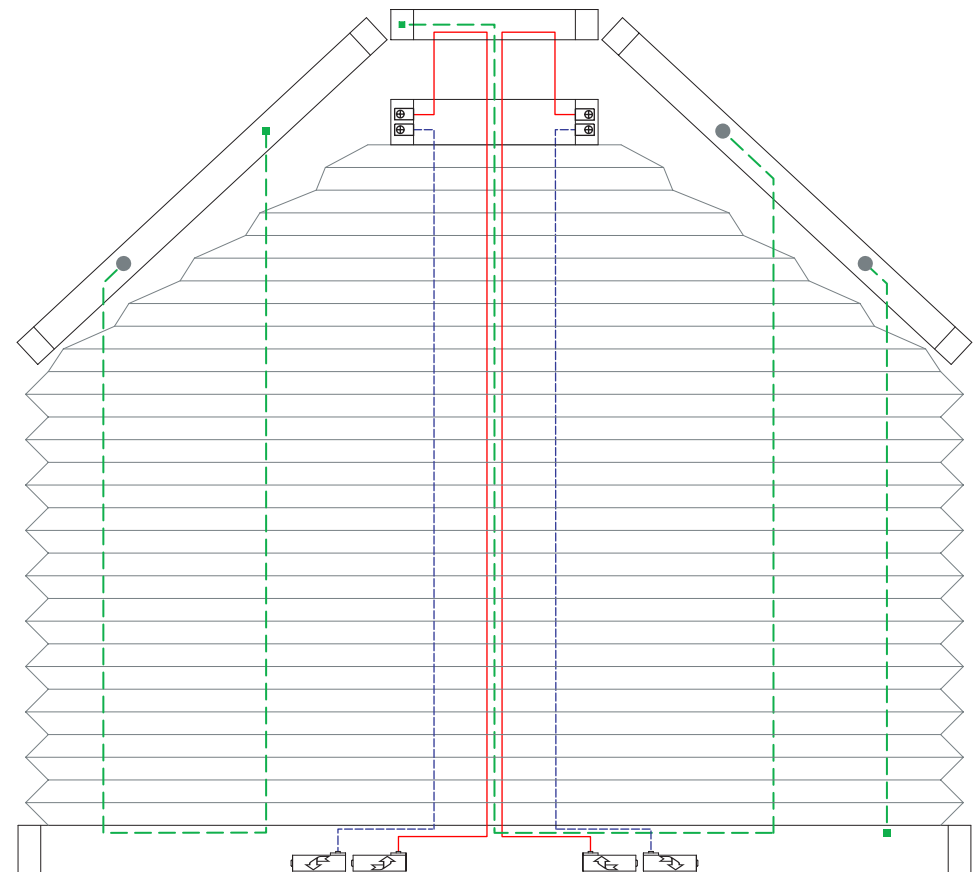

3 Drahtbohrungen/Wire boreholes/Passages de fil





5 Drahtbohrungen/Wire boreholes/Passages de fil



P 3863-1

-  1. Wickelschnur/Winding cord/Cordon d'enroulement Ø1,2 mm
-  2. Wickelschnur/Winding cord/Cordon d'enroulement Ø1,2 mm
-  Spanndraht/Tension wire/Fil de tension Ø0,8 mm
-  SOMFY CTS 25 Schnurwickler/Cord winder/Dévidoir de cordon



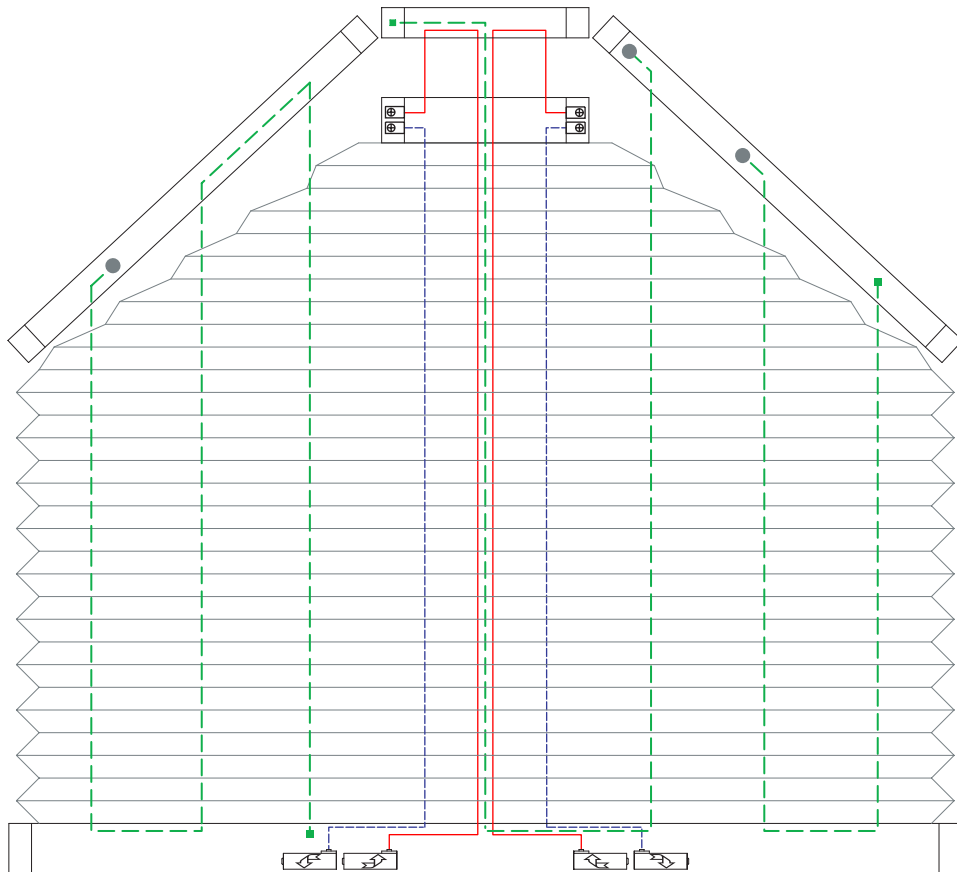

-  Drahtspanner/Wire stretcher/Tendeur de fil
-  Schnurspanner/Cord stretcher/Tendeur de cordon





7 Drahtbohrungen/Wire boreholes/Passages de fil



P 3863-2

-  1. Wickelschnur/Winding cord/Cordon d'enroulement Ø1,2 mm
-  2. Wickelschnur/Winding cord/Cordon d'enroulement Ø1,2 mm
-  Spanndraht/Tension wire/Fil de tension Ø0,8 mm
-  SOMFY CTS 25 Schnurwickler/Cord winder/Dévidoir de cordon

-  Drahtspanner/Wire stretcher/Tendeur de fil
-  Schnurspanner/Cord stretcher/Tendeur de cordon

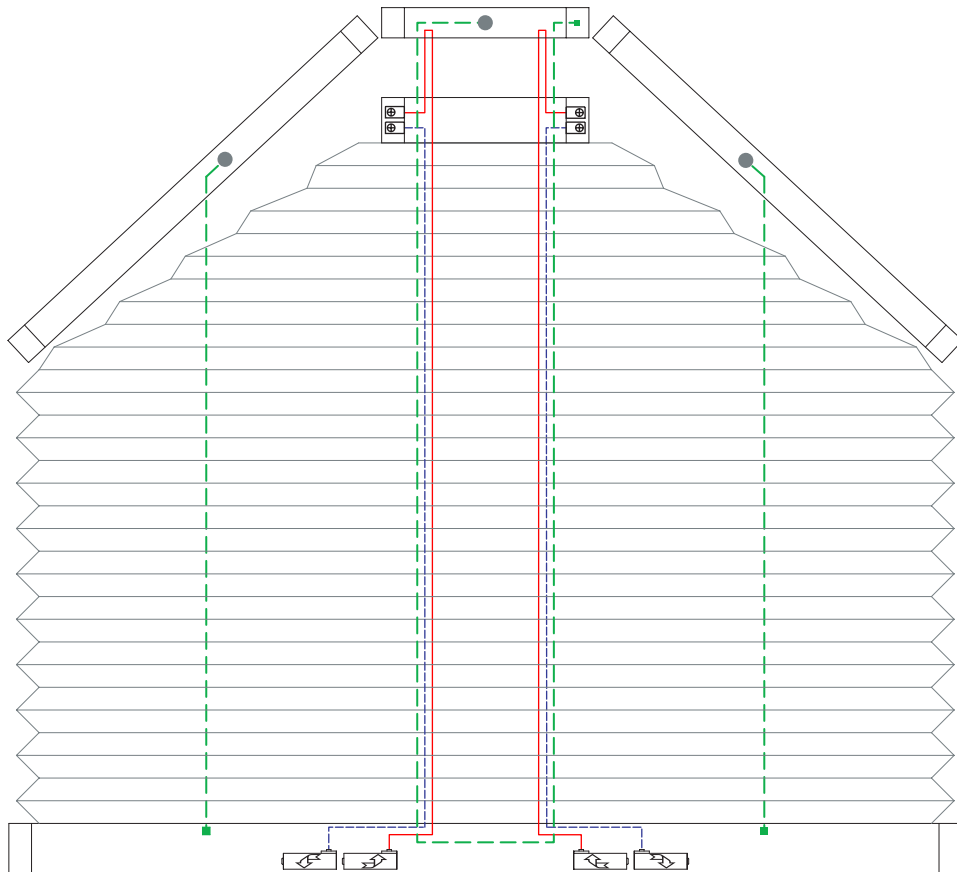

4 Drahtbohrungen/Wire boreholes/Passages de fil

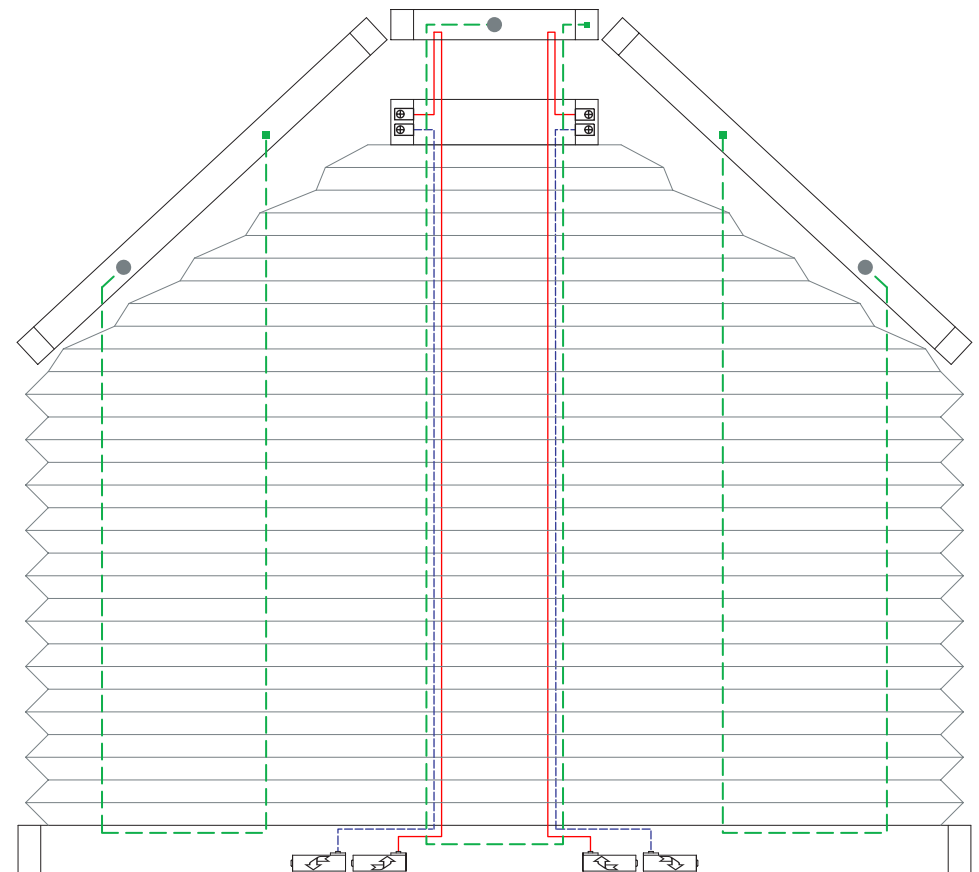

6 Drahtbohrungen/Wire boreholes/Passages de fil



P 3863-2

- 1. Wickelschnur/Winding cord/Cordon d'enroulement Ø1,2 mm
- 2. Wickelschnur/Winding cord/Cordon d'enroulement Ø1,2 mm
- Spanndraht/Tension wire/Fil de tension Ø0,8 mm
- SOMFY CTS 25 Schnurwickler/Cord winder/Dévidoir de cordon



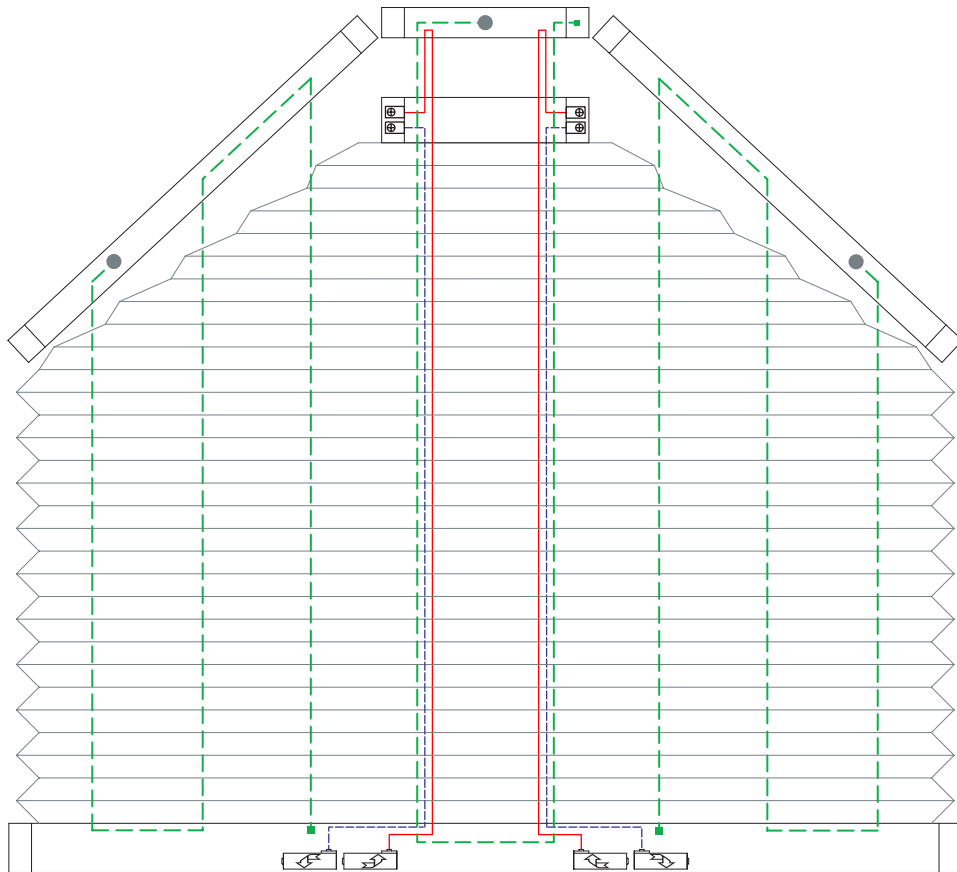

- Drahtspanner/Wire stretcher/Tendeur de fil
- Schnurspanner/Cord stretcher/Tendeur de cordon





8 Drahtbohrungen/Wire boreholes/Passages de fil



P 3863-3

-  1. Wickelschnur/Winding cord/Cordon d'enroulement Ø1,2 mm
-  2. Wickelschnur/Winding cord/Cordon d'enroulement Ø1,2 mm
-  Spanndraht/Tension wire/Fil de tension Ø0,8 mm
-  SOMFY CTS 25 Schnurwickler/Cord winder/Dévidoir de cordon

-  Drahtspanner/Wire stretcher/Tendeur de fil
-  Schnurspanner/Cord stretcher/Tendeur de cordon

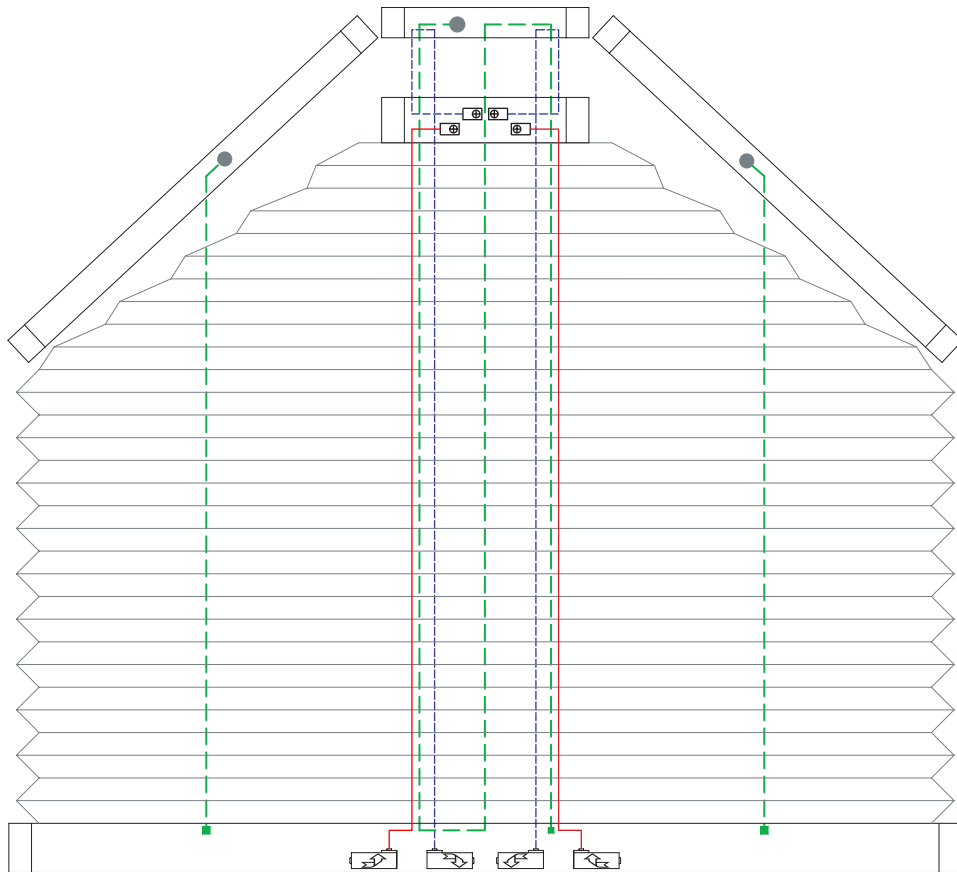



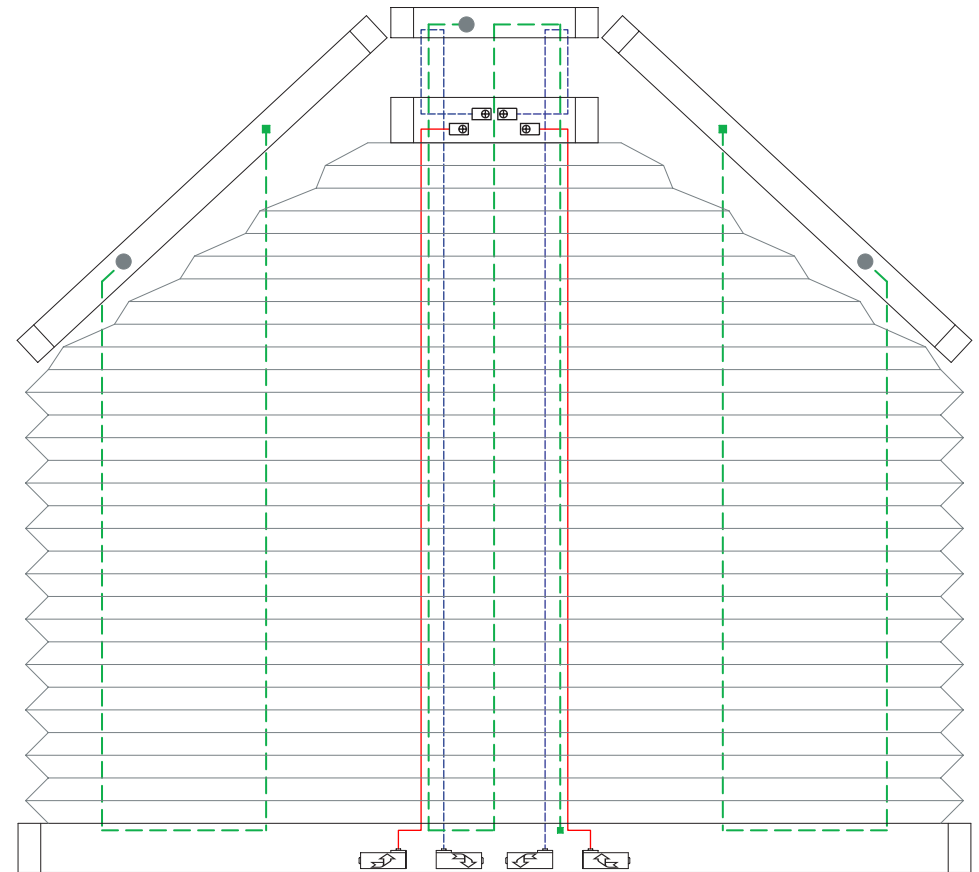

5 Drahtbohrungen/Wire boreholes/Passages de fil





7 Drahtbohrungen/Wire boreholes/Passages de fil



P 3863-3

-  1. Wickelschnur/Winding cord/Cordon d'enroulement Ø1,2 mm
-  2. Wickelschnur/Winding cord/Cordon d'enroulement Ø1,2 mm
-  Spanndraht/Tension wire/Fil de tension Ø0,8 mm
-  SOMFY CTS 25 Schnurwickler/Cord winder/Dévidoir de cordon



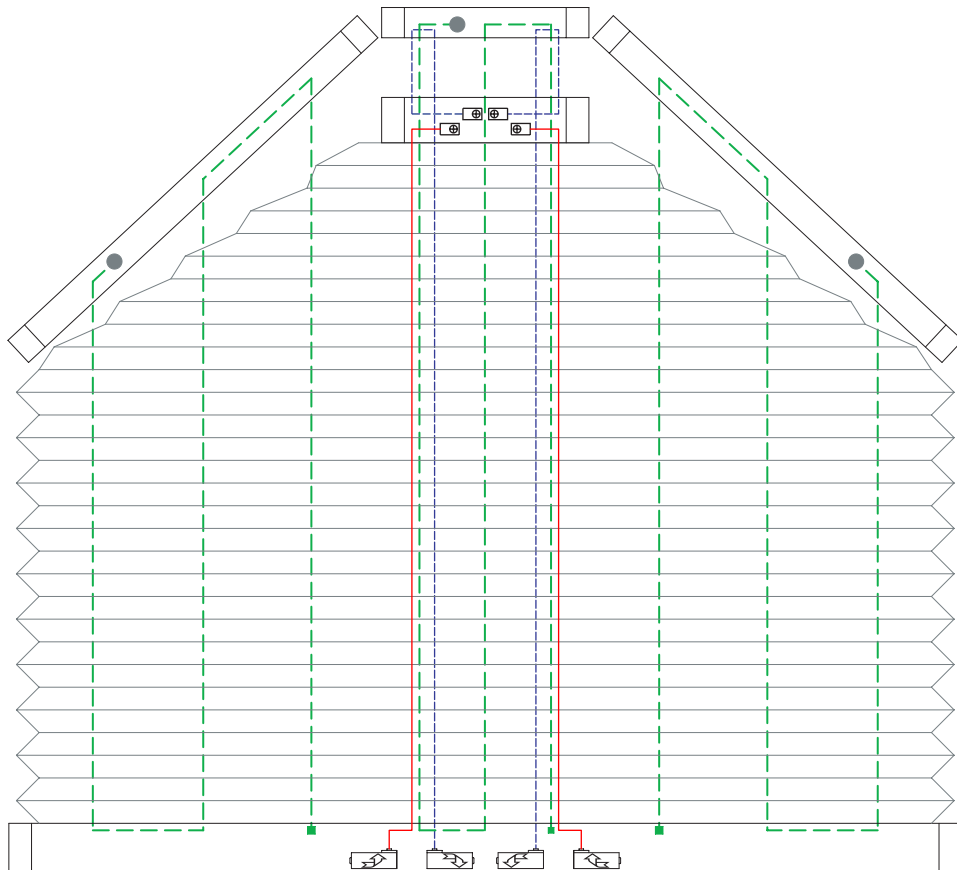

-  Drahtspanner/Wire stretcher/Tendeur de fil
-  Schnurspanner/Cord stretcher/Tendeur de cordon





9 Drahtbohrungen/Wire boreholes/Passages de fil



P 3863-4

-  1. Wickelschnur/Winding cord/Cordon d'enroulement Ø1,2 mm
-  2. Wickelschnur/Winding cord/Cordon d'enroulement Ø1,2 mm
-  Spanndraht/Tension wire/Fil de tension Ø0,8 mm
-  SOMFY CTS 25 Schnurwickler/Cord winder/Dévidoir de cordon

-  Drahtspanner/Wire stretcher/Tendeur de fil
-  Schnurspanner/Cord stretcher/Tendeur de cordon

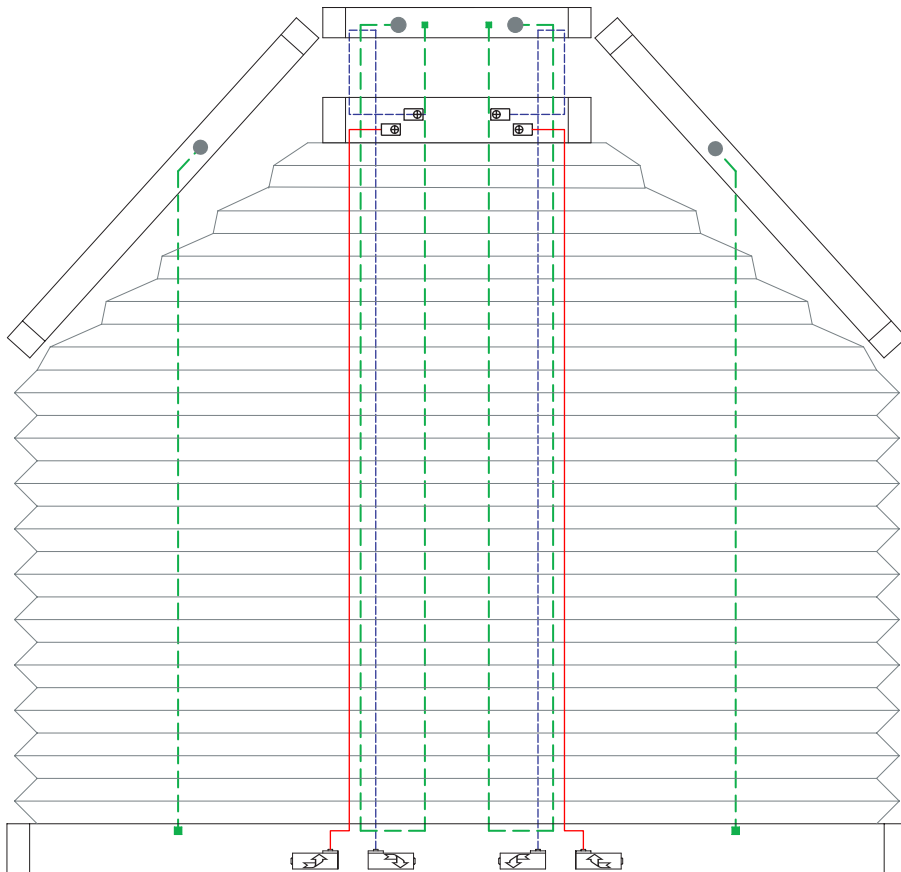



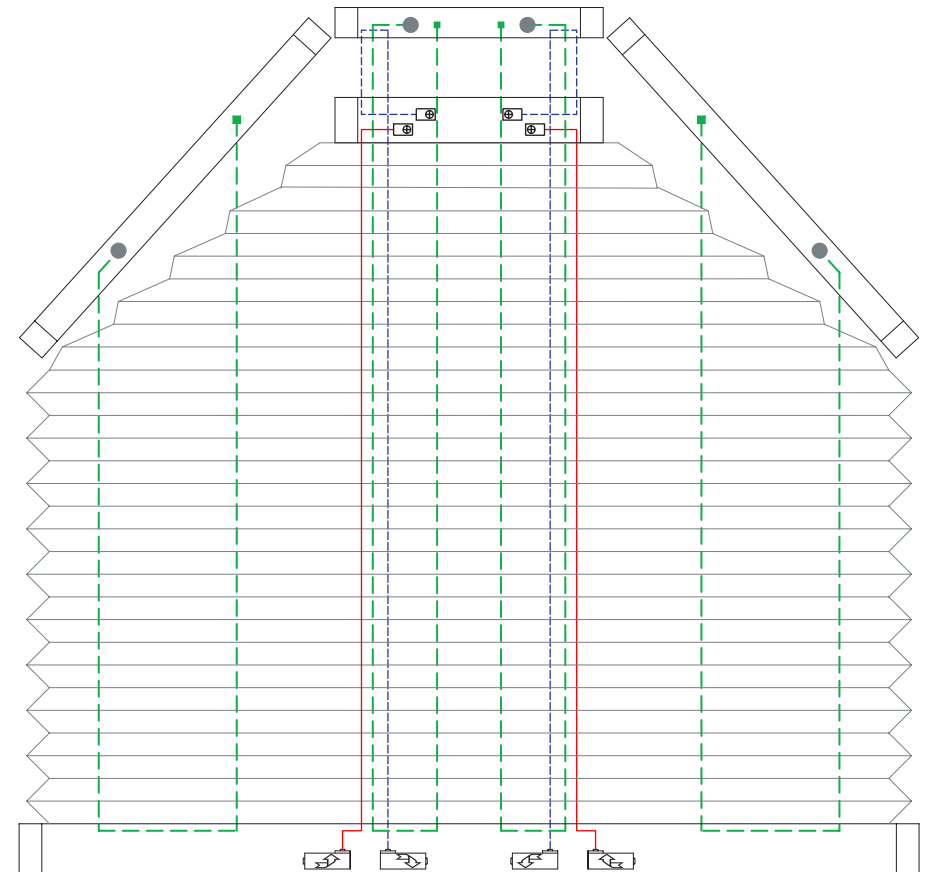

6 Drahtbohrungen/Wire boreholes/Passages de fil





8 Drahtbohrungen/Wire boreholes/Passages de fil



P 3863-5

-  1. Wickelschnur/Winding cord/Cordon d'enroulement Ø1,2 mm
-  2. Wickelschnur/Winding cord/Cordon d'enroulement Ø1,2 mm
-  Spanndraht/Tension wire/Fil de tension Ø0,8 mm
-  SOMFY CTS 25 Schnurwickler/Cord winder/Dévidoir de cordon



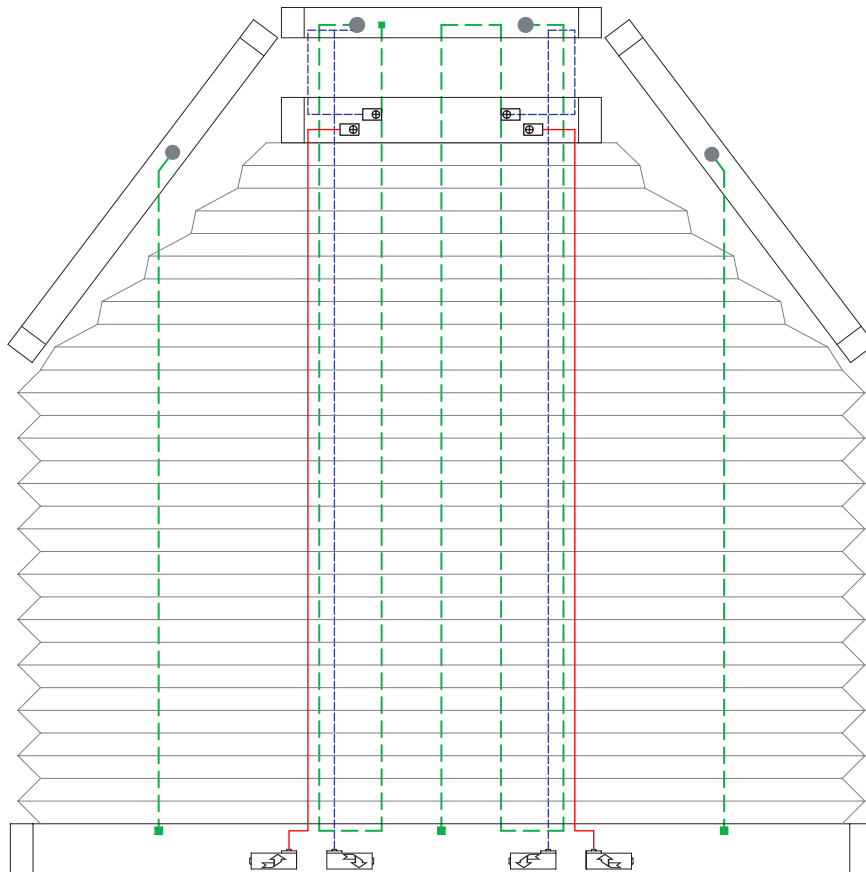

-  Drahtspanner/Wire stretcher/Tendeur de fil
-  Schnurspanner/Cord stretcher/Tendeur de cordon





7 Drahtbohrungen/Wire boreholes/Passages de fil



P 3863-6

-  1. Wickelschnur/Winding cord/Cordon d'enroulement Ø1,2 mm
-  2. Wickelschnur/Winding cord/Cordon d'enroulement Ø1,2 mm
-  Spanndraht/Tension wire/Fil de tension Ø0,8 mm
-  SOMFY CTS 25 Schnurwickler/Cord winder/Dévidoir de cordon

-  Drahtspanner/Wire stretcher/Tendeur de fil
-  Schnurspanner/Cord stretcher/Tendeur de cordon

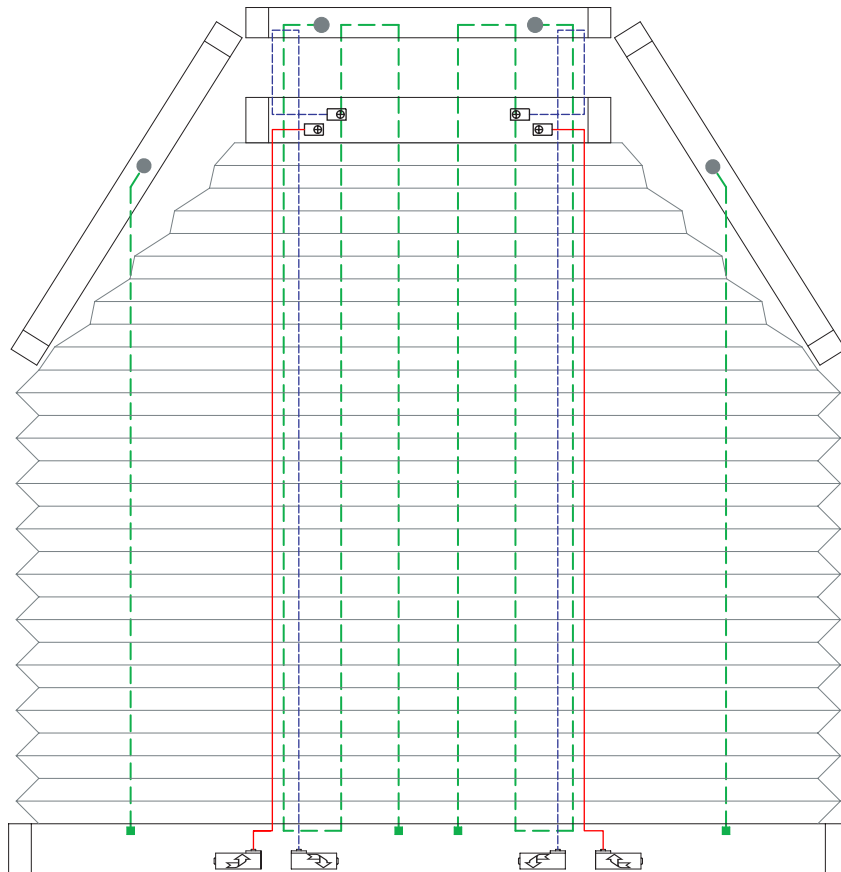

8 Drahtbohrungen/Wire boreholes/Passages de fil



P 3930-1

- 1. Wickelschnur/Winding cord/Cordon d'enroulement Ø1,2 mm
- - - 2. Wickelschnur/Winding cord/Cordon d'enroulement Ø1,2 mm
- SOMFY CTS 25 Schnurwickler/Cord winder/Dévidoir de cordon
- - - Spanndraht/Tension wire/Fil de tension Ø0,8 mm

- Drahtspanner/Wire stretcher/Tendeur de fil
- Schnurspanner/Cord stretcher/Tendeur de cordon

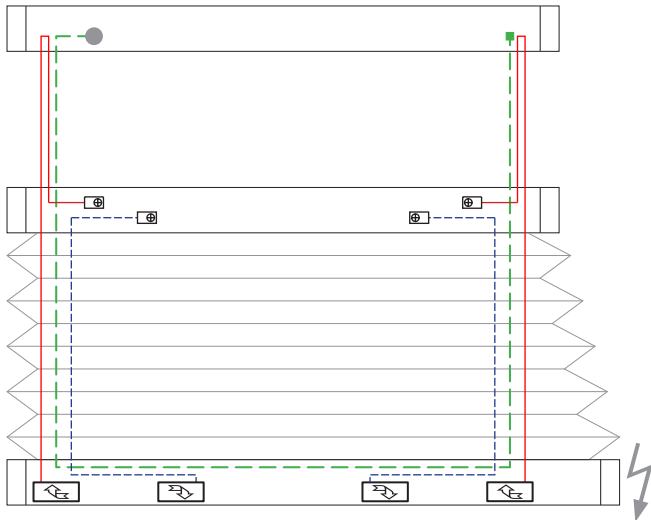

2 Drahtbohrungen/Wire boreholes/Passages de fil

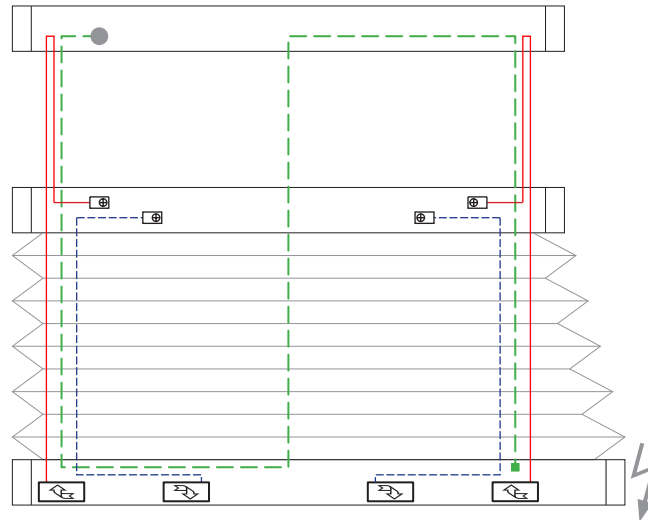

3 Drahtbohrungen/Wire boreholes/Passages de fil

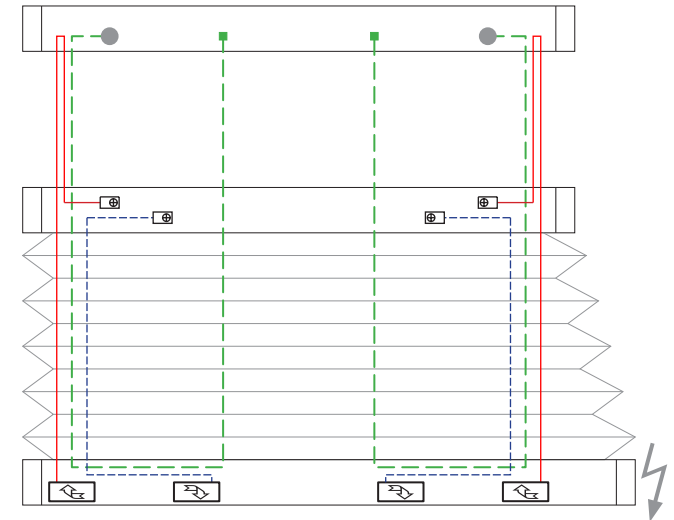

4 Drahtbohrungen/Wire boreholes/Passages de fil

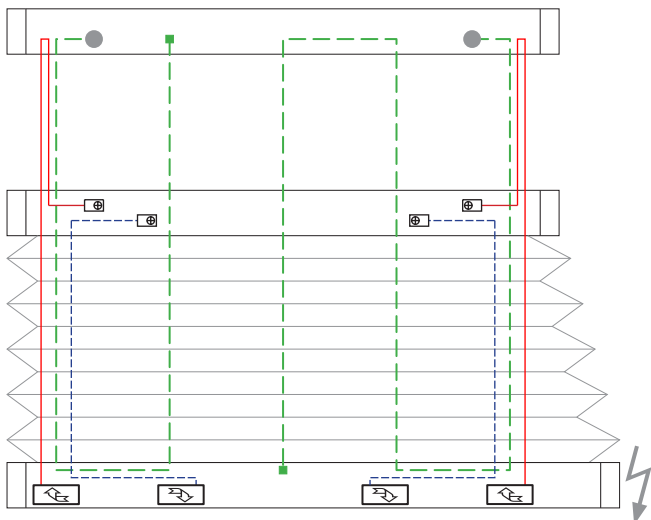

5 Drahtbohrungen/Wire boreholes/Passages de fil

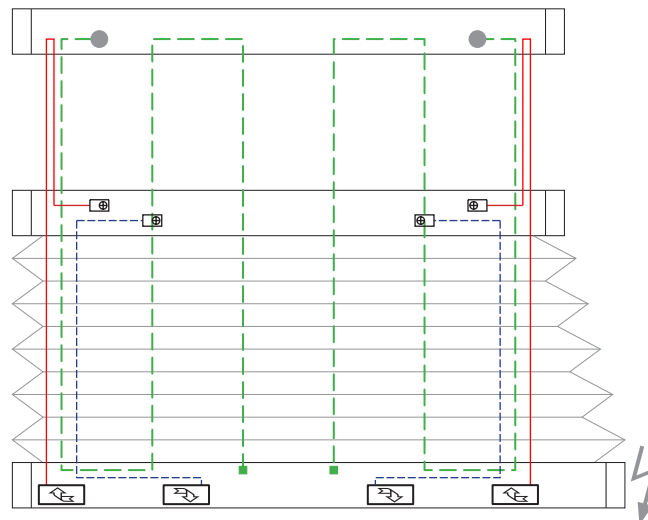

6 Drahtbohrungen/Wire boreholes/Passages de fil



P 3930-2

- 1. Wickelschnur/Winding cord/Cordon d'enroulement Ø1,2 mm
- - - 2. Wickelschnur/Winding cord/Cordon d'enroulement Ø1,2 mm
- SOMFY CTS 25 Schnurwickler/Cord winder/Dévidoir de cordon
- - - Spanndraht/Tension wire/Fil de tension Ø0,8 mm

- Drahtspanner/Wire stretcher/Tendeur de fil
- Schnurspanner/Cord stretcher/Tendeur de cordon

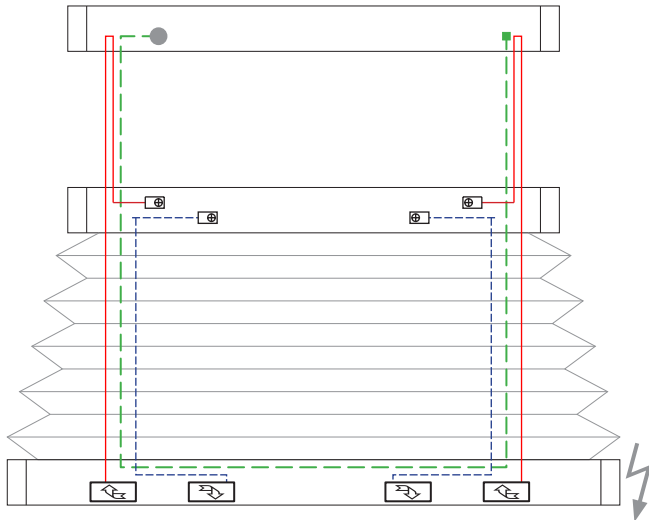

2 Drahtbohrungen/Wire boreholes/Passages de fil

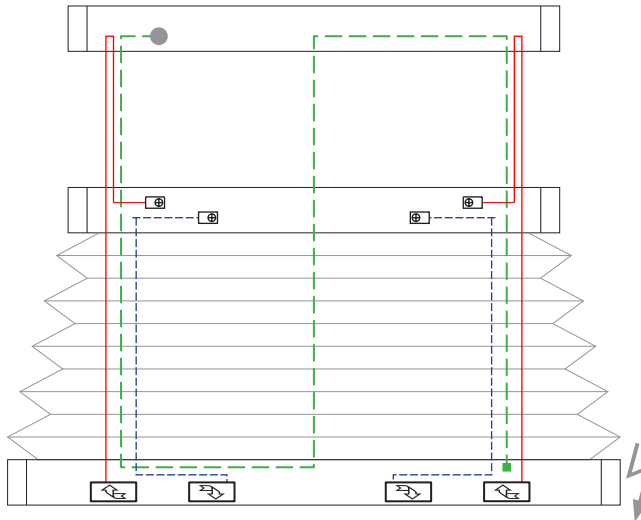

3 Drahtbohrungen/Wire boreholes/Passages de fil

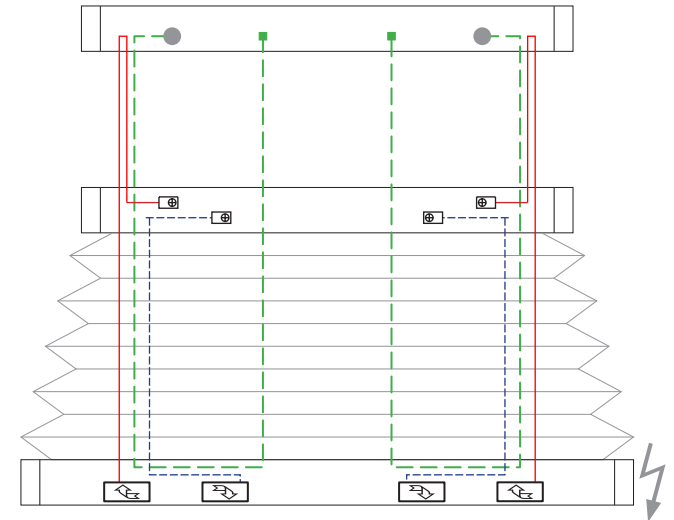

4 Drahtbohrungen/Wire boreholes/Passages de fil

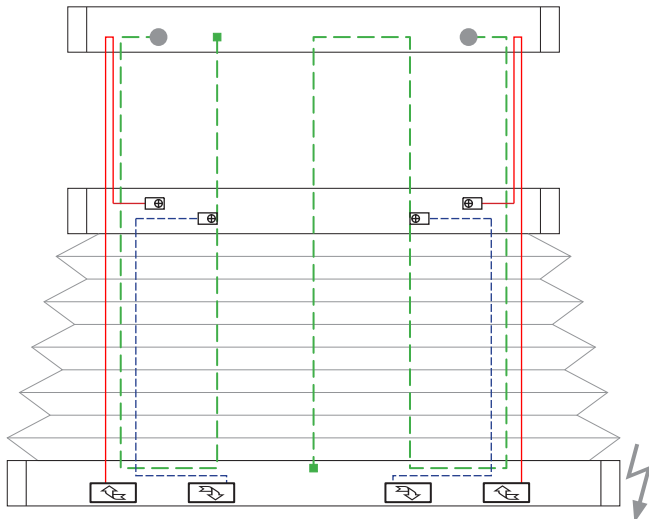

5 Drahtbohrungen/Wire boreholes/Passages de fil

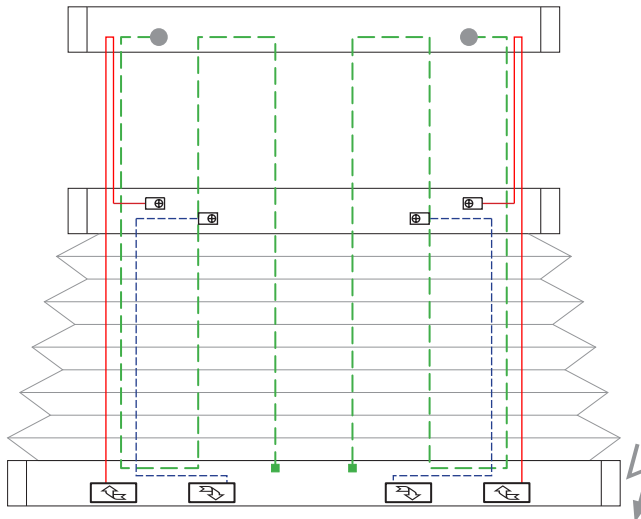

6 Drahtbohrungen/Wire boreholes/Passages de fil



P 3930-3

- 1. Wickelschnur/Winding cord/Cordon d'enroulement Ø1,2 mm
- - - 2. Wickelschnur/Winding cord/Cordon d'enroulement Ø1,2 mm
- - - Gummiband/Rubber band/Ruban en caoutchouc Ø1,25 mm
- SOMFY CTS 25 Schnurwickler/Cord winder/Dévidoir de cordon

- - - Spanndraht/Tension wire/Fil de tension Ø0,8 mm
- Drahtspanner/Wire stretcher/Tendeur de fil
- Schnurspanner/Cord stretcher/Tendeur de cordon

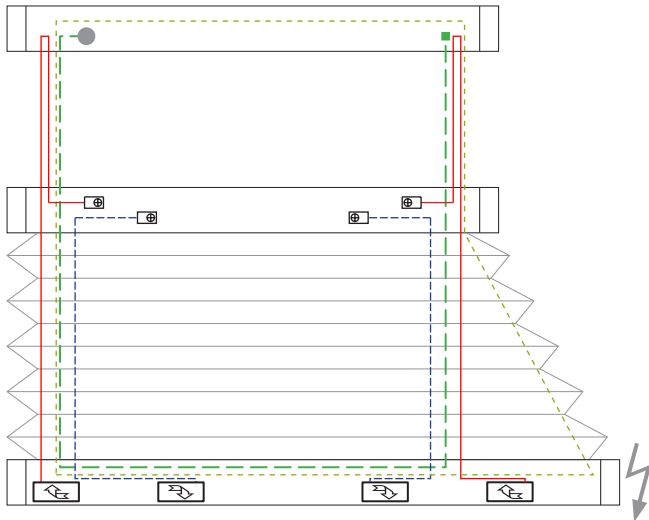

2 Drahtbohrungen/Wire boreholes/Passages de fil

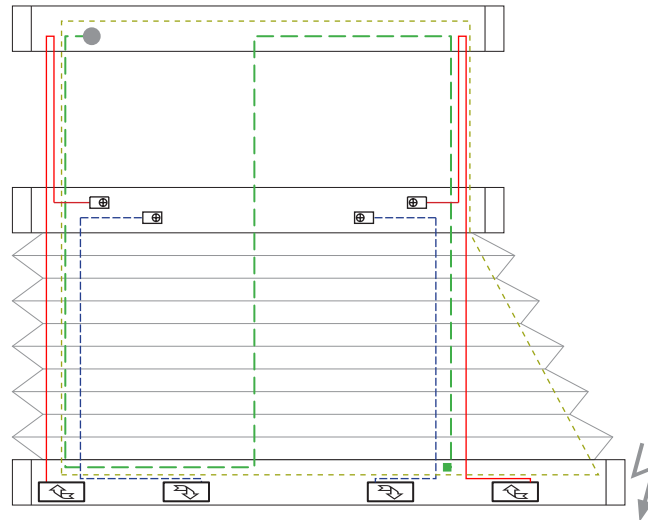

3 Drahtbohrungen/Wire boreholes/Passages de fil

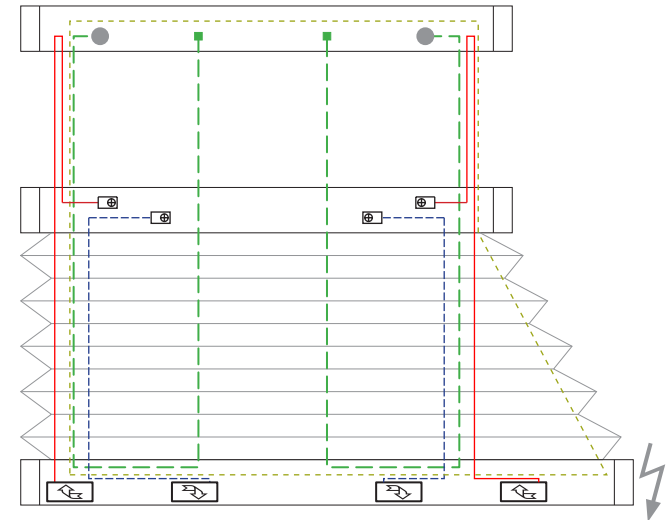

4 Drahtbohrungen/Wire boreholes/Passages de fil

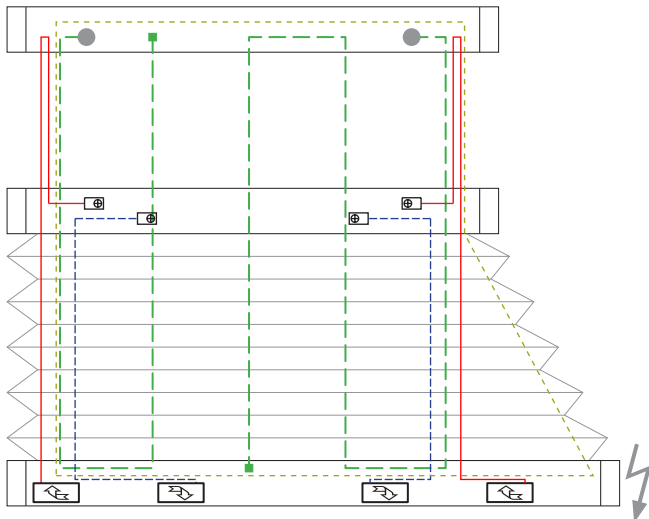

5 Drahtbohrungen/Wire boreholes/Passages de fil

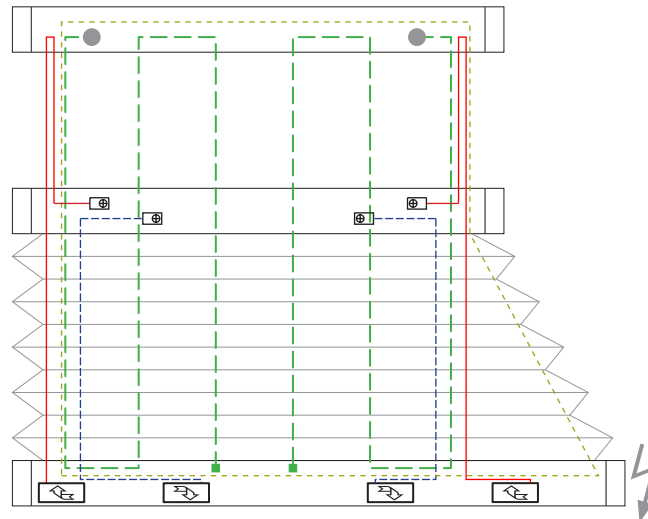

6 Drahtbohrungen/Wire boreholes/Passages de fil



P 3930-4

- 1. Wickelschnur/Winding cord/Cordon d'enroulement Ø1,2 mm
- - - 2. Wickelschnur/Winding cord/Cordon d'enroulement Ø1,2 mm
- - - Gummiband/Rubber band/Ruban en caoutchouc Ø1,25 mm
- SOMFY CTS 25 Schnurwickler/Cord winder/Dévidoir de cordon

- - - Spanndraht/Tension wire/Fil de tension Ø0,8 mm
- Drahtspanner/Wire stretcher/Tendeur de fil
- Schnurspanner/Cord stretcher/Tendeur de cordon

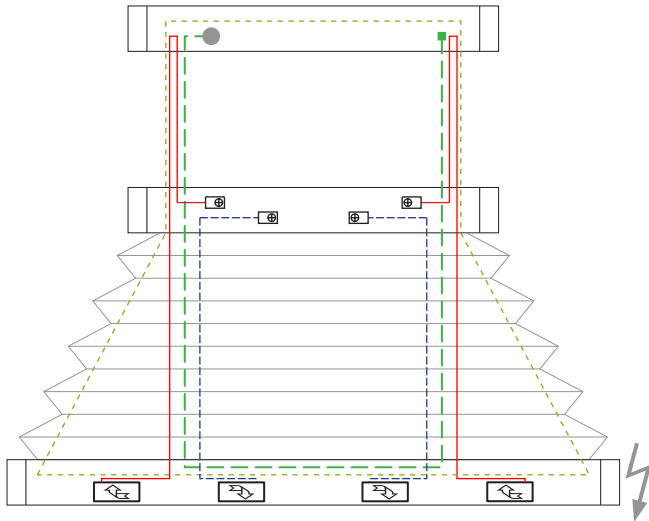

2 Drahtbohrungen/Wire boreholes/Passages de fil

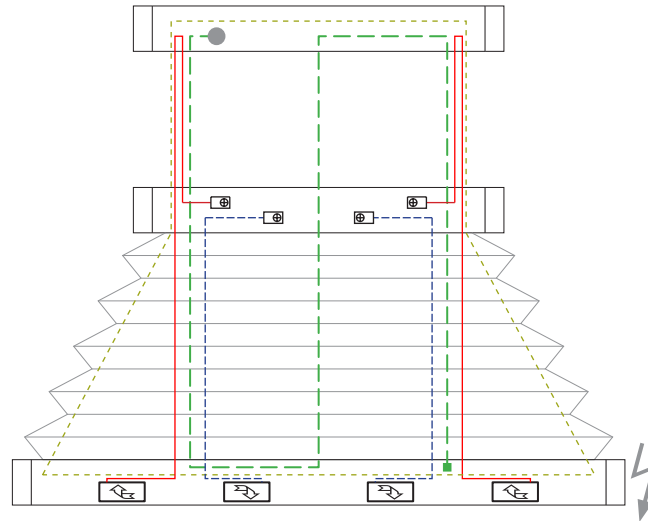

3 Drahtbohrungen/Wire boreholes/Passages de fil

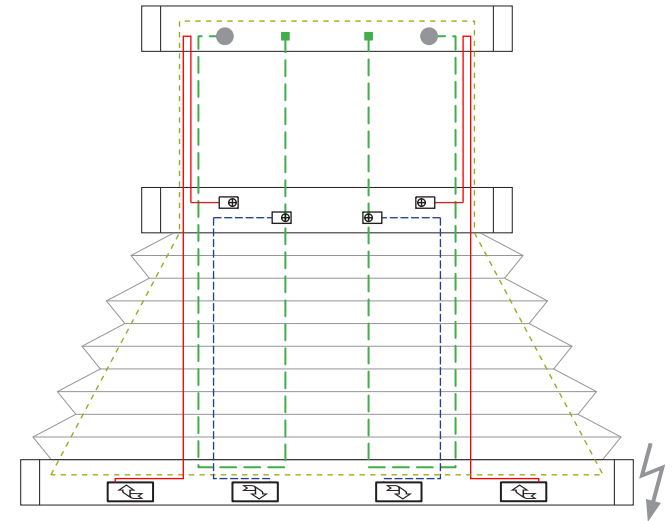

4 Drahtbohrungen/Wire boreholes/Passages de fil

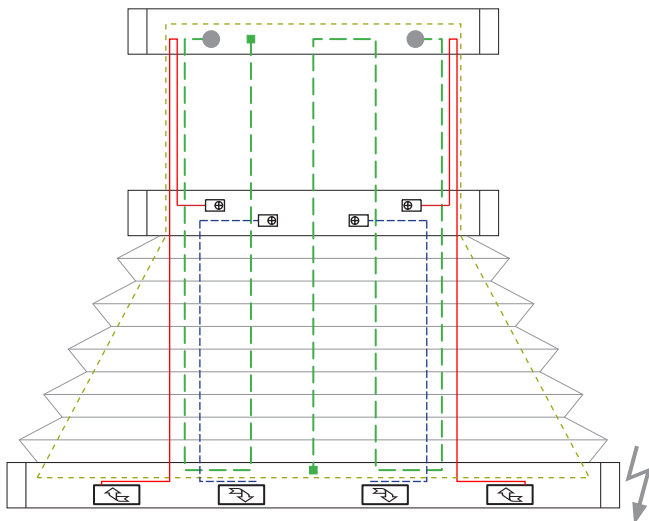



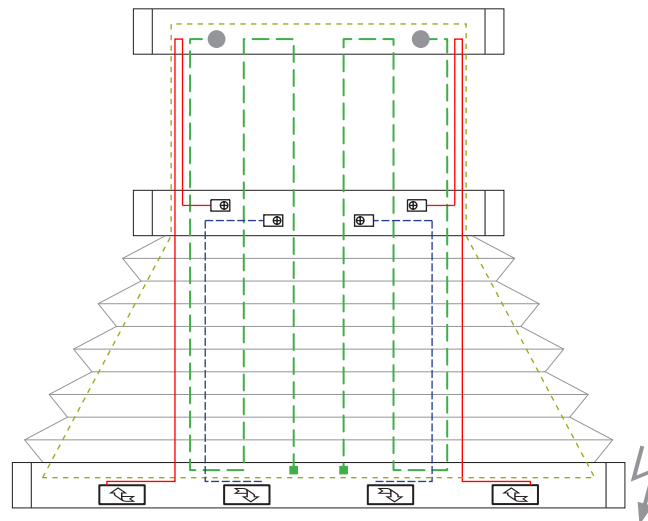

5 Drahtbohrungen/Wire boreholes/Passages de fil





6 Drahtbohrungen/Wire boreholes/Passages de fil



P 3934-1

-  1. Wickelschnur/Winding cord/Cordon d'enroulement Ø1,2 mm
-  2. Wickelschnur/Winding cord/Cordon d'enroulement Ø1,2 mm
-  Gummiband/Rubber band/Ruban en caoutchouc Ø1,25 mm
-  SOMFY CTS 25 Schnurwickler/Cord winder/Dévidoir de cordon

-  Spanndraht/Tension wire/Fil de tension Ø0,8 mm
-  Drahtspanner/Wire stretcher/Tendeur de fil

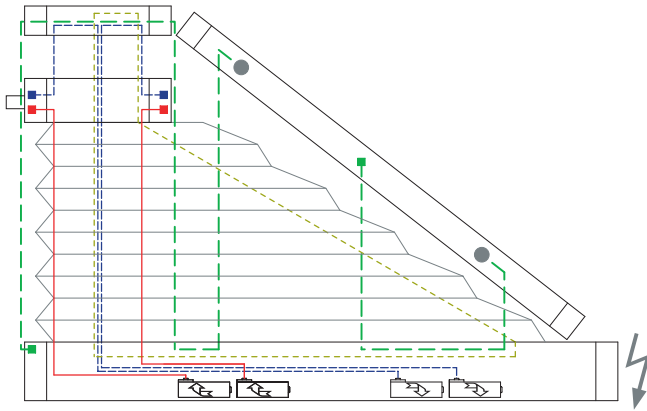

4 Drahtbohrungen/Wire boreholes/Passages de fil

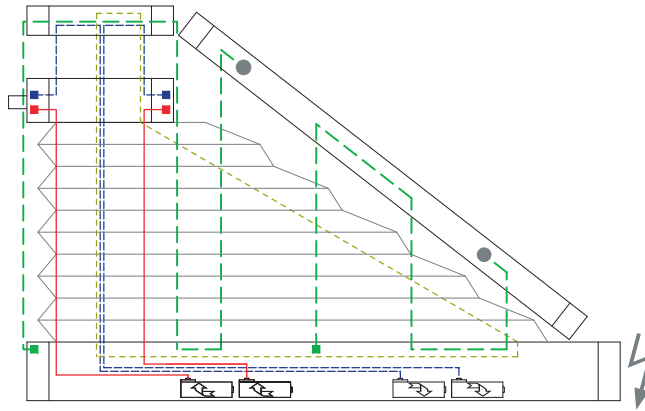



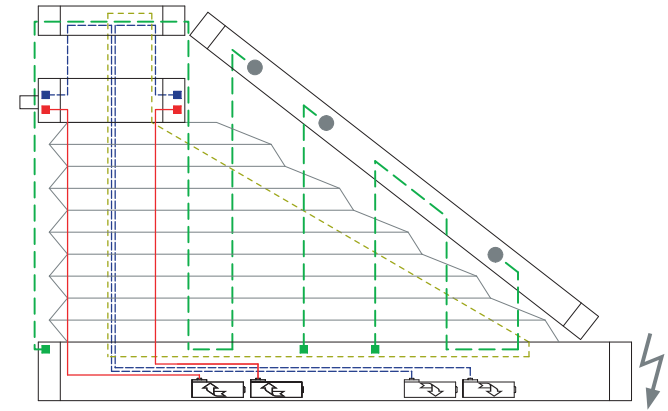

5 Drahtbohrungen/Wire boreholes/Passages de fil





6 Drahtbohrungen/Wire boreholes/Passages de fil



P 3934-2

-  1. Wickelschnur/Winding cord/Cordon d'enroulement Ø1,2 mm
-  2. Wickelschnur/Winding cord/Cordon d'enroulement Ø1,2 mm
-  Gummiband/Rubber band/Ruban en caoutchouc Ø1,25 mm
-  SOMFY CTS 25 Schnurwickler/Cord winder/Dévidoir de cordon

-  Spanndraht/Tension wire/Fil de tension Ø0,8 mm
-  Drahtspanner/Wire stretcher/Tendeur de fil
-  Schnurspanner/Cord stretcher/Tendeur de cordon

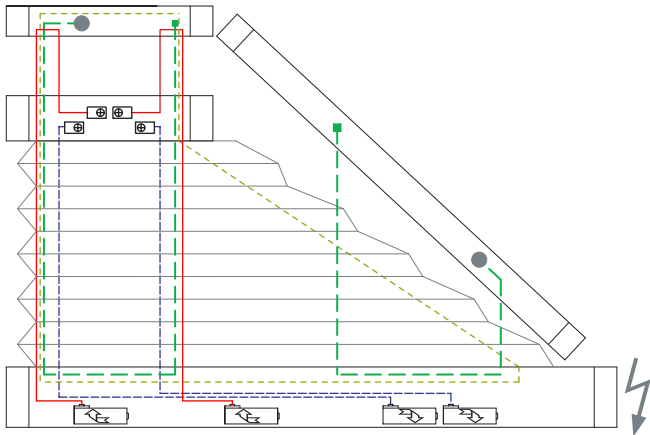

4 Drahtbohrungen/Wire boreholes/Passages de fil

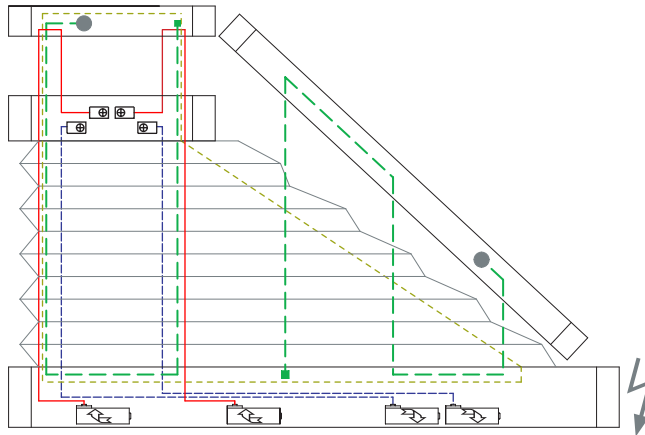



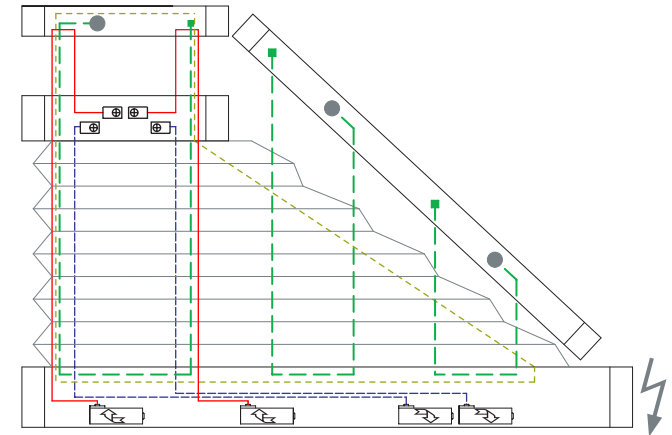

5 Drahtbohrungen/Wire boreholes/Passages de fil





6 Drahtbohrungen/Wire boreholes/Passages de fil



P 3934-3

-  1. Wickelschnur/Winding cord/Cordon d'enroulement Ø1,2 mm
-  2. Wickelschnur/Winding cord/Cordon d'enroulement Ø1,2 mm
-  Gummiband/Rubber band/Ruban en caoutchouc Ø1,25 mm
-  SOMFY CTS 25 Schnurwickler/Cord winder/Dévidoir de cordon

-  Spanndraht/Tension wire/Fil de tension Ø0,8 mm
-  Drahtspanner/Wire stretcher/Tendeur de fil
-  Schnurspanner/Cord stretcher/Tendeur de cordon

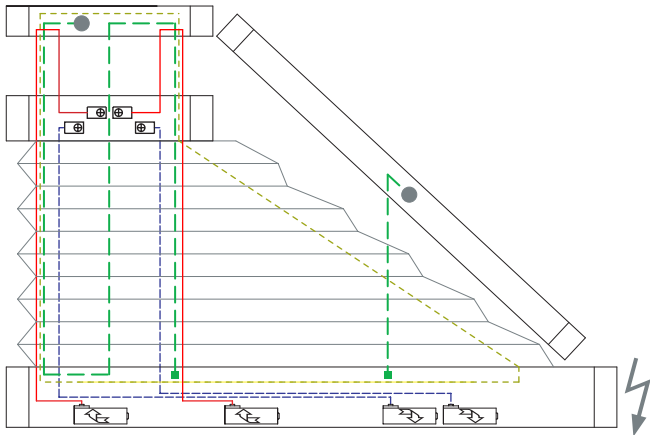

4 Drahtbohrungen/Wire boreholes/Passages de fil

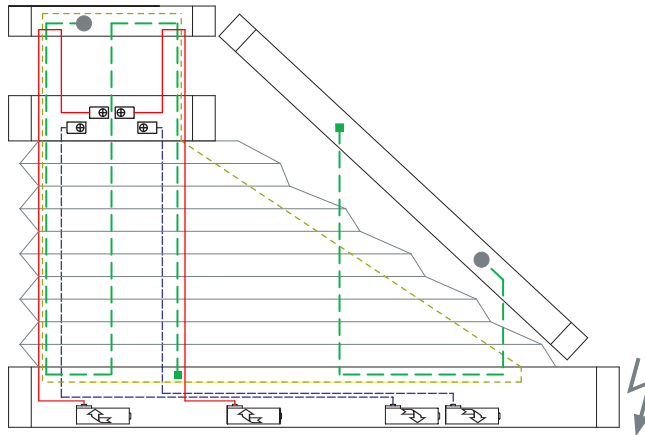



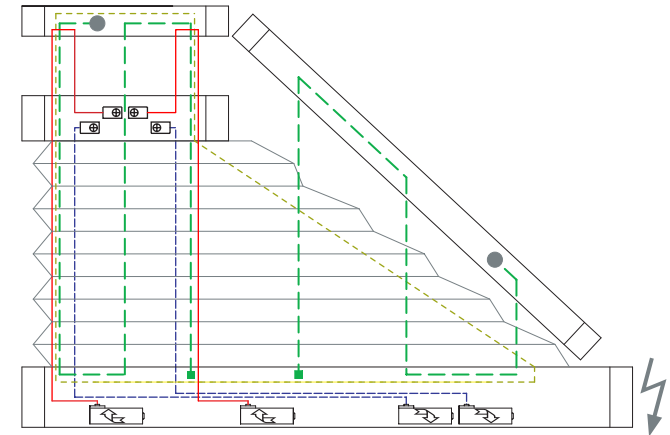

5 Drahtbohrungen/Wire boreholes/Passages de fil





6 Drahtbohrungen/Wire boreholes/Passages de fil



P 3934-4

-  1. Wickelschnur/Winding cord/Cordon d'enroulement Ø1,2 mm
-  2. Wickelschnur/Winding cord/Cordon d'enroulement Ø1,2 mm
-  Gummiband/Rubber band/Ruban en caoutchouc Ø1,25 mm
-  SOMFY CTS 25 Schnurwickler/Cord winder/Dévidoir de cordon

-  Spanndraht/Tension wire/Fil de tension Ø0,8 mm
-  Drahtspanner/Wire stretcher/Tendeur de fil
-  Schnurspanner/Cord stretcher/Tendeur de cordon

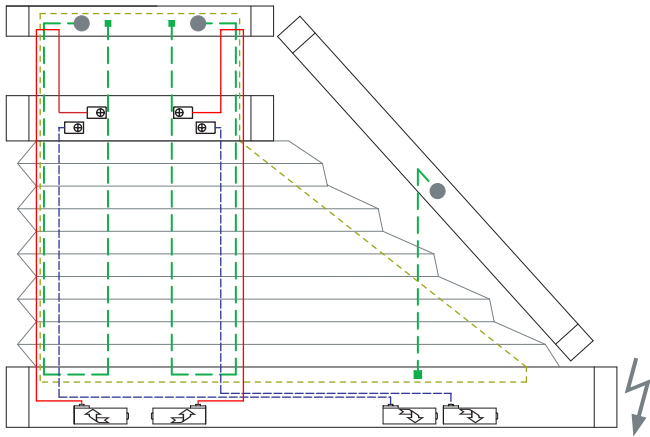



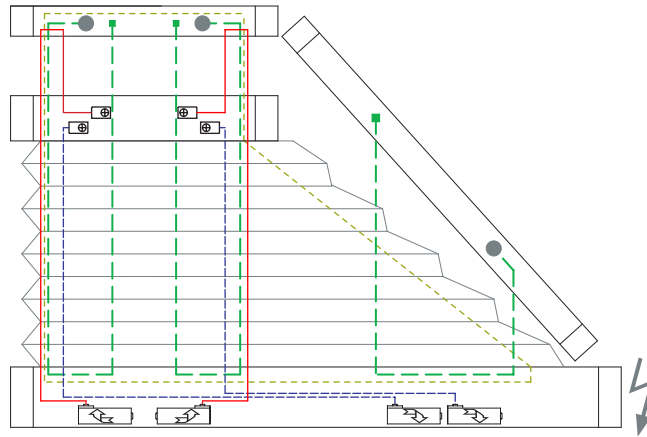

5 Drahtbohrungen/Wire boreholes/Passages de fil





6 Drahtbohrungen/Wire boreholes/Passages de fil



P 3934-5

-  1. Wickelschnur/Winding cord/Cordon d'enroulement Ø1,2 mm
-  2. Wickelschnur/Winding cord/Cordon d'enroulement Ø1,2 mm
-  Gummiband/Rubber band/Ruban en caoutchouc Ø1,25 mm
-  SOMFY CTS 25 Schnurwickler/Cord winder/Dévidoir de cordon



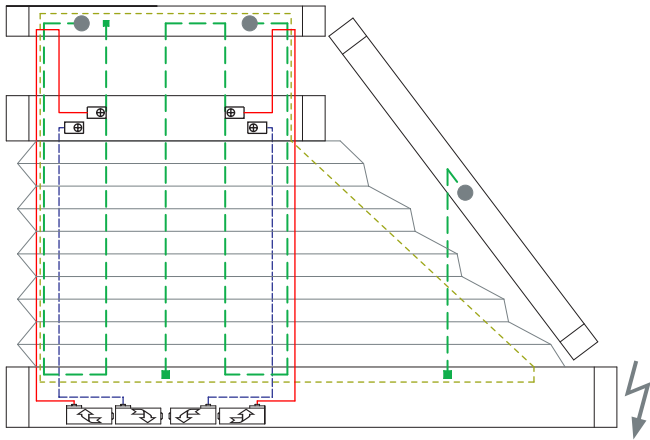

-  Spanndraht/Tension wire/Fil de tension Ø0,8 mm
-  Drahtspanner/Wire stretcher/Tendeur de fil
-  Schnurspanner/Cord stretcher/Tendeur de cordon





6 Drahtbohrungen/Wire boreholes/Passages de fil



P 3934-6

-  1. Wickelschnur/Winding cord/Cordon d'enroulement Ø1,2 mm
-  2. Wickelschnur/Winding cord/Cordon d'enroulement Ø1,2 mm
-  Gummiband/Rubber band/Ruban en caoutchouc Ø1,25 mm
-  SOMFY CTS 25 Schnurwickler/Cord winder/Dévidoir de cordon

-  Spanndraht/Tension wire/Fil de tension Ø0,8 mm
-  Drahtspanner/Wire stretcher/Tendeur de fil
-  Schnurspanner/Cord stretcher/Tendeur de cordon

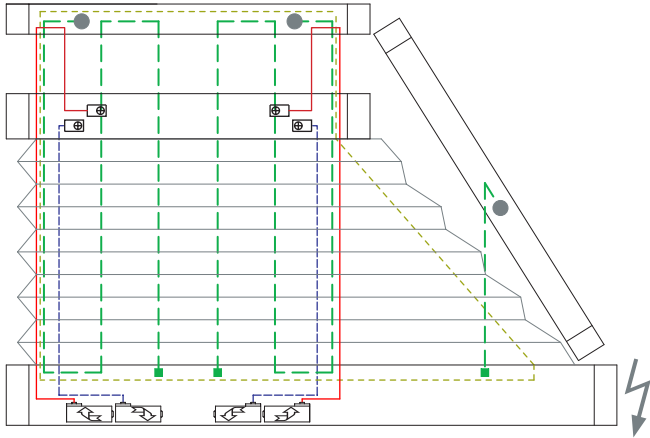

7 Drahtbohrungen/Wire boreholes/Passages de fil



P 3935-2

- 1. Wickelschnur/Winding cord/Cordon d'enroulement Ø1,2 mm
- - - 2. Wickelschnur/Winding cord/Cordon d'enroulement Ø1,2 mm
- - - Gummiband/Rubber band/Ruban en caoutchouc Ø1,25 mm
- SOMFY CTS 25 Schnurwickler/Cord winder/Dévidoir de cordon

- - - Spanndraht/Tension wire/Fil de tension Ø0,8 mm
- Drahtspanner/Wire stretcher/Tendeur de fil
- Schnurspanner/Cord stretcher/Tendeur de cordon

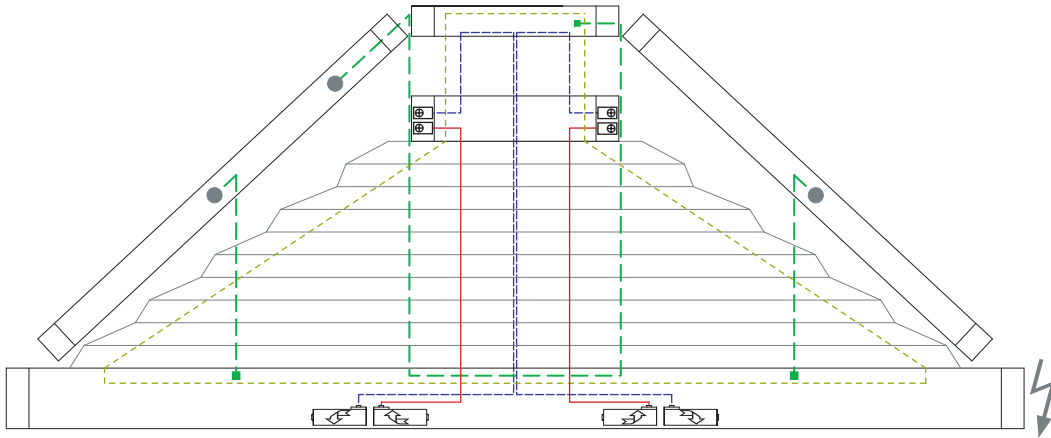

4 Drahtbohrungen/Wire boreholes/Passages de fil

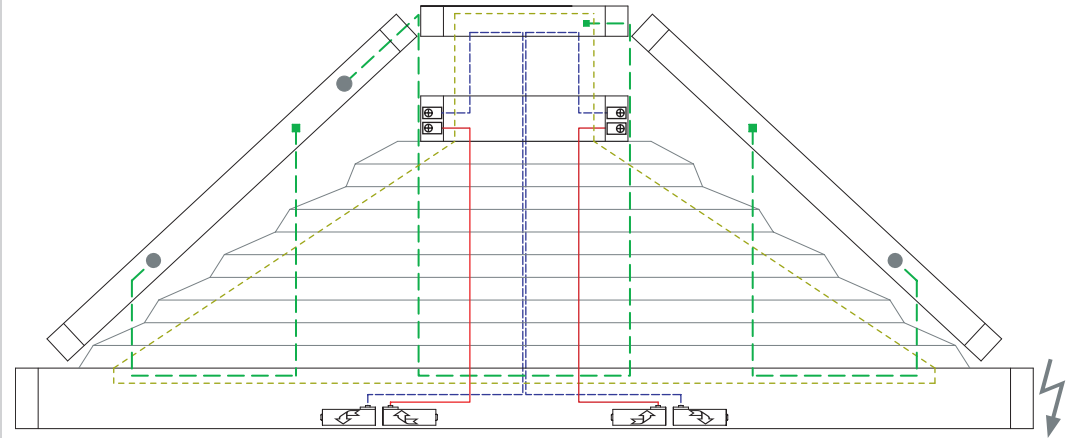

6 Drahtbohrungen/Wire boreholes/Passages de fil

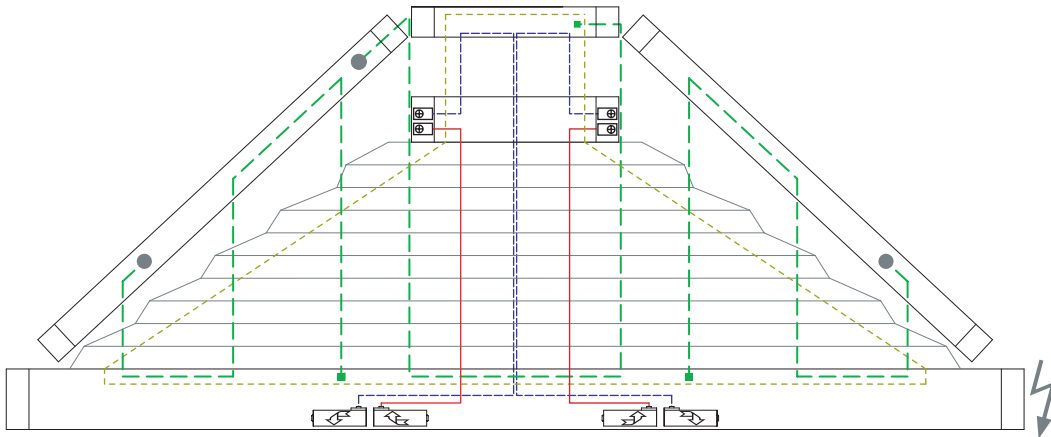

8 Drahtbohrungen/Wire boreholes/Passages de fil



P 3935-3

- 1. Wickelschnur/Winding cord/Cordon d'enroulement Ø1,2 mm
- - - 2. Wickelschnur/Winding cord/Cordon d'enroulement Ø1,2 mm
- - - Gummiband/Rubber band/Ruban en caoutchouc Ø1,25 mm
- SOMFY CTS 25 Schnurwickler/Cord winder/Dévidoir de cordon

- - - Spanndraht/Tension wire/Fil de tension Ø0,8 mm
- Drahtspanner/Wire stretcher/Tendeur de fil
- Schnurspanner/Cord stretcher/Tendeur de cordon

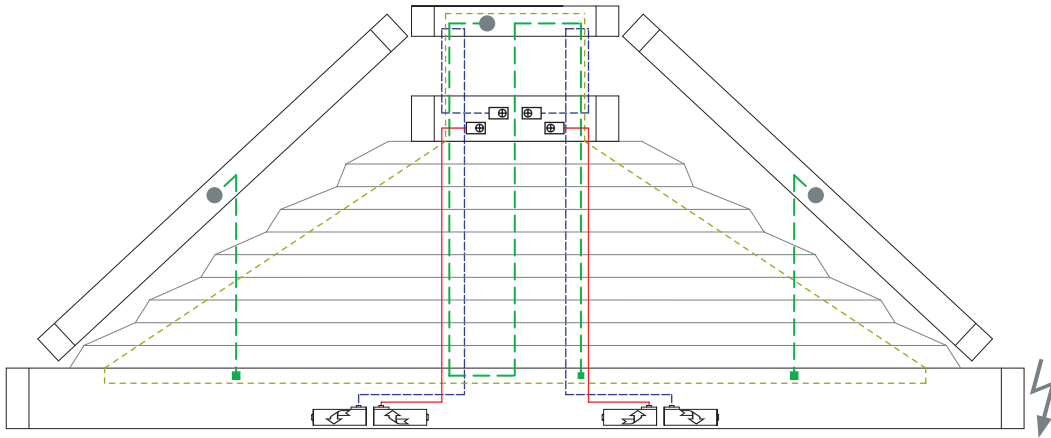

5 Drahtbohrungen/Wire boreholes/Passages de fil

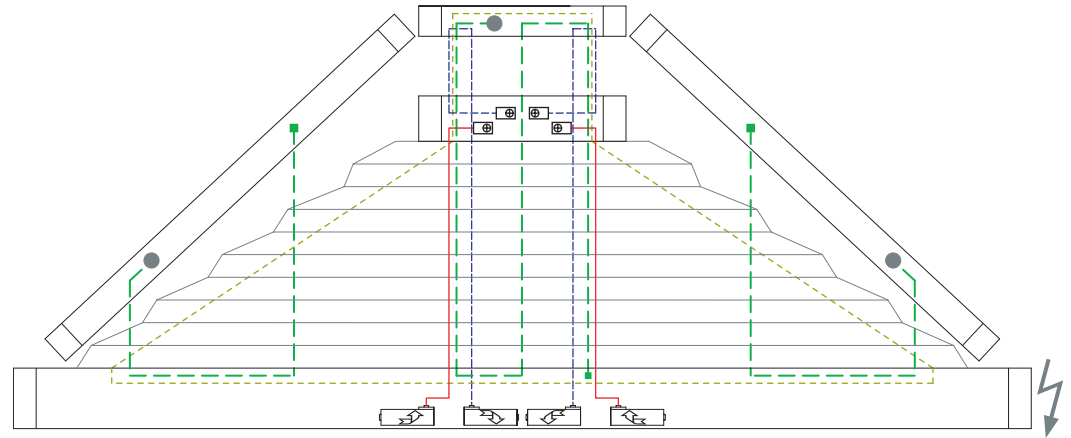



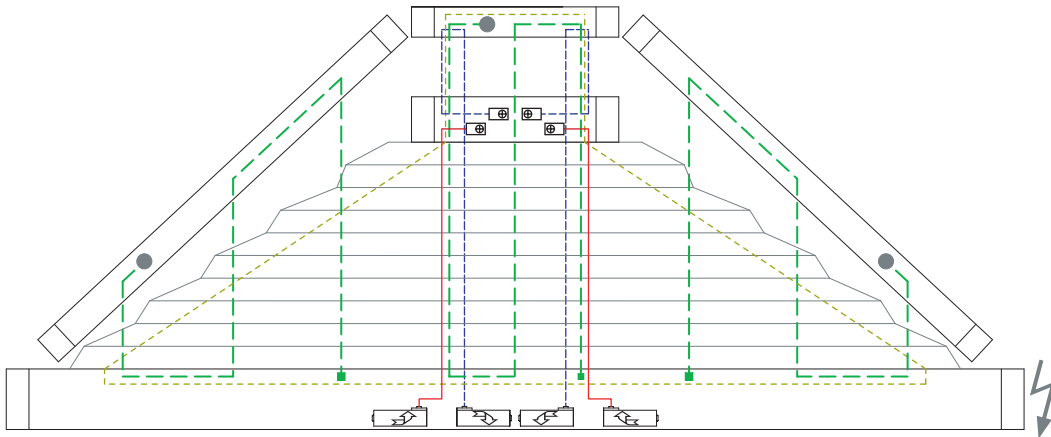

7 Drahtbohrungen/Wire boreholes/Passages de fil





9 Drahtbohrungen/Wire boreholes/Passages de fil



P 3935-4

-  1. Wickelschnur/Winding cord/Cordon d'enroulement Ø1,2 mm
-  2. Wickelschnur/Winding cord/Cordon d'enroulement Ø1,2 mm
-  Gummiband/Rubber band/Ruban en caoutchouc Ø1,25 mm
-  SOMFY CTS 25 Schnurwickler/Cord winder/Dévidoir de cordon

-  Spanndraht/Tension wire/Fil de tension Ø0,8 mm
-  Drahtspanner/Wire stretcher/Tendeur de fil
-  Schnurspanner/Cord stretcher/Tendeur de cordon

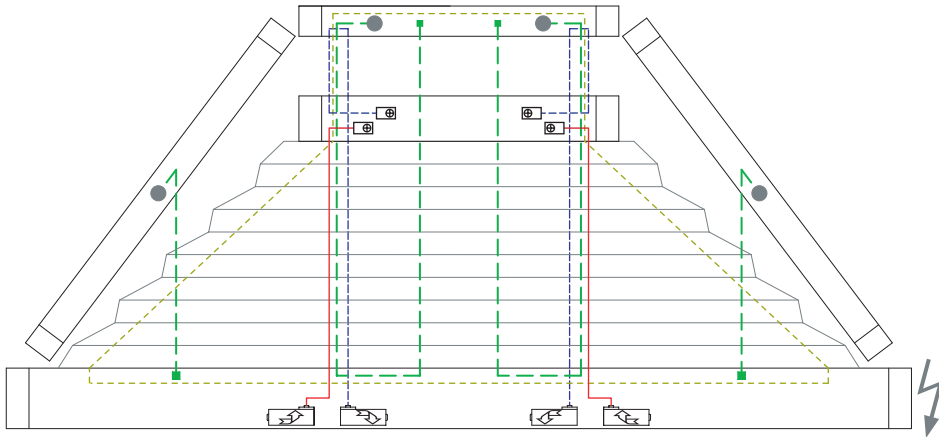



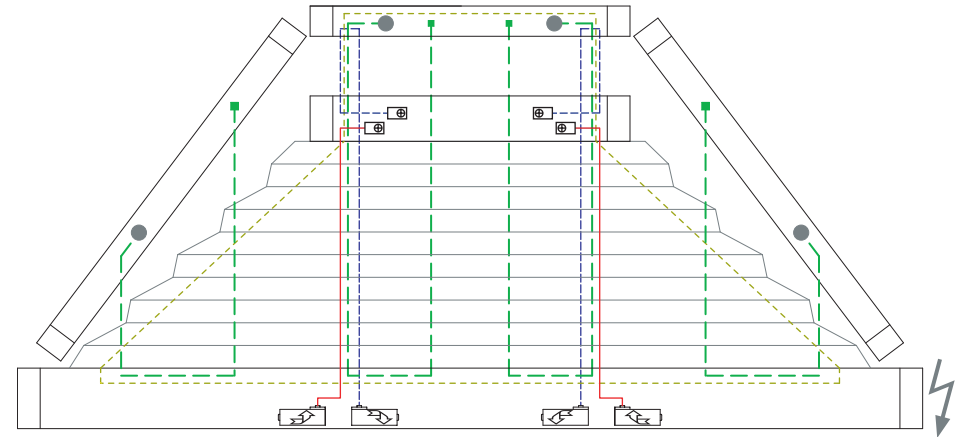

6 Drahtbohrungen/Wire boreholes/Passages de fil





8 Drahtbohrungen/Wire boreholes/Passages de fil



P 3935-5

-  1. Wickelschnur/Winding cord/Cordon d'enroulement Ø1,2 mm
-  2. Wickelschnur/Winding cord/Cordon d'enroulement Ø1,2 mm
-  Gummiband/Rubber band/Ruban en caoutchouc Ø1,25 mm
-  SOMFY CTS 25 Schnurwickler/Cord winder/Dévidoir de cordon

-  Spanndraht/Tension wire/Fil de tension Ø0,8 mm
-  Drahtspanner/Wire stretcher/Tendeur de fil
-  Schnurspanner/Cord stretcher/Tendeur de cordon

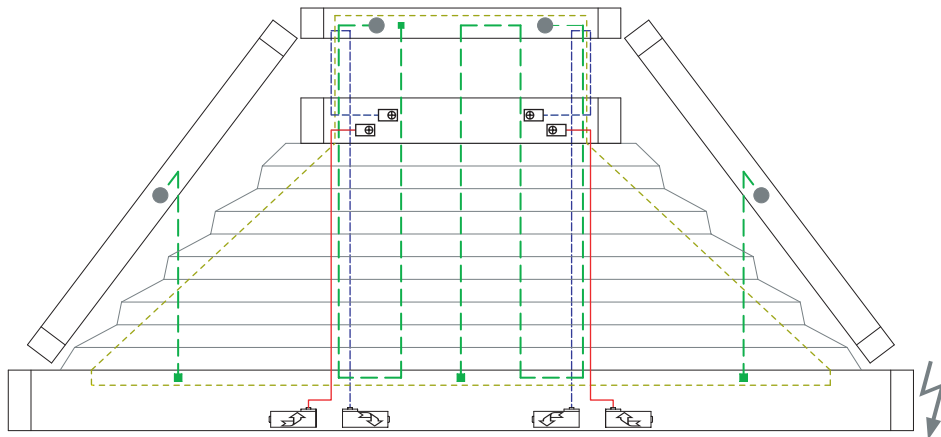



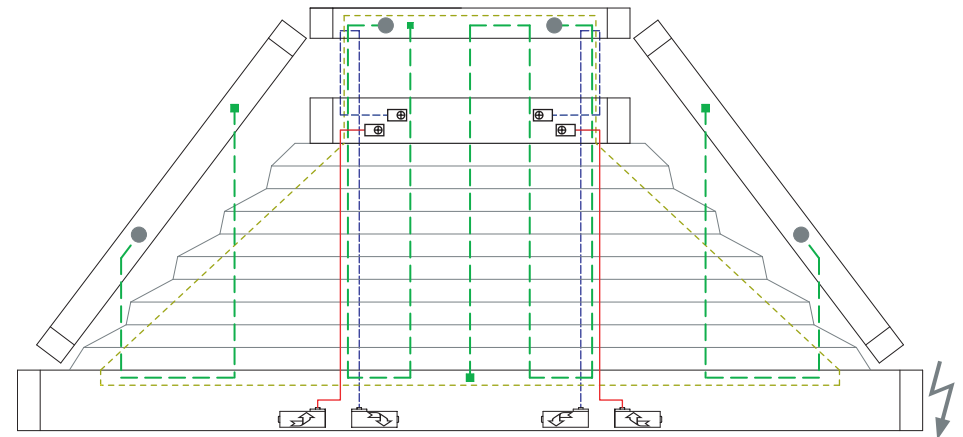

7 Drahtbohrungen/Wire boreholes/Passages de fil





9 Drahtbohrungen/Wire boreholes/Passages de fil



P 3935-6

-  1. Wickelschnur/Winding cord/Cordon d'enroulement Ø1,2 mm
-  2. Wickelschnur/Winding cord/Cordon d'enroulement Ø1,2 mm
-  Gummiband/Rubber band/Ruban en caoutchouc Ø1,25 mm
-  SOMFY CTS 25 Schnurwickler/Cord winder/Dévidoir de cordon

-  Spanndraht/Tension wire/Fil de tension Ø0,8 mm
-  Drahtspanner/Wire stretcher/Tendeur de fil
-  Schnurspanner/Cord stretcher/Tendeur de cordon

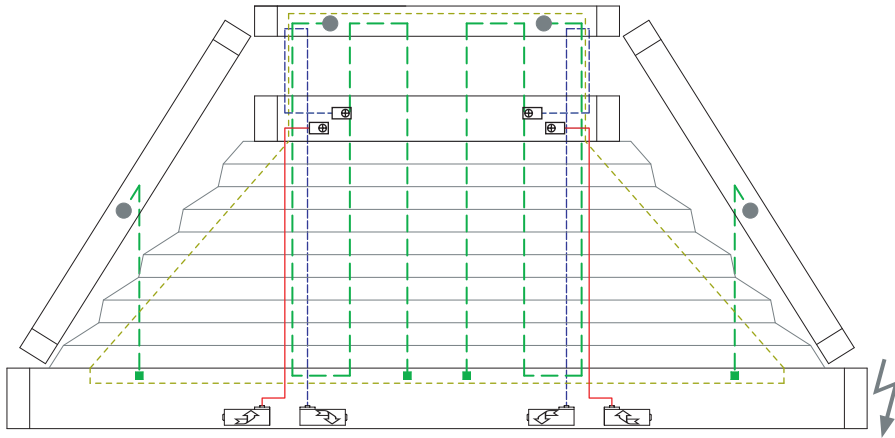

8 Drahtbohrungen/Wire boreholes/Passages de fil



P 3936

- 1. Wickelschnur/Winding cord/Cordon d'enroulement Ø1,2 mm
- - - 2. Wickelschnur/Winding cord/Cordon d'enroulement Ø1,2 mm
- - - Gummiband/Rubber band/Ruban en caoutchouc Ø1,25 mm
- SOMFY CTS 25 Schnurwickler/Cord winder/Dévidoir de cordon

- - - Spanndraht/Tension wire/Fil de tension Ø0,8 mm
- Drahtspanner/Wire stretcher/Tendeur de fil

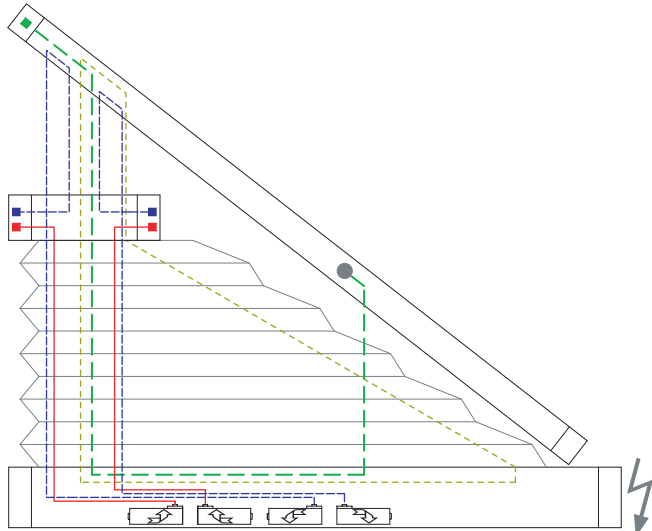

2 Drahtbohrungen/Wire boreholes/Passages de fil

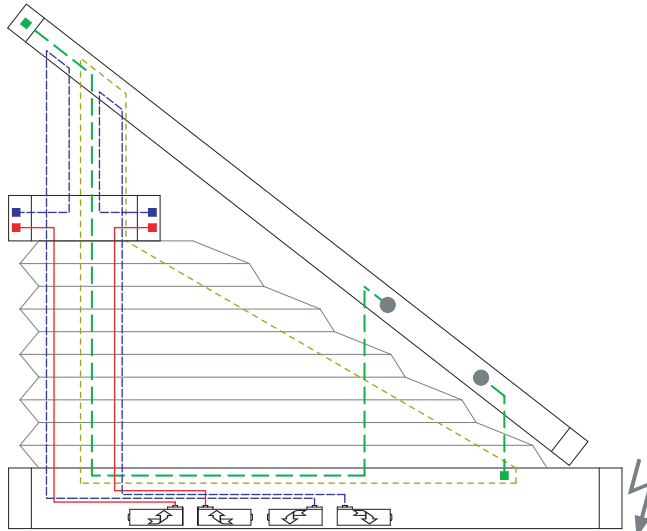

3 Drahtbohrungen/Wire boreholes/Passages de fil

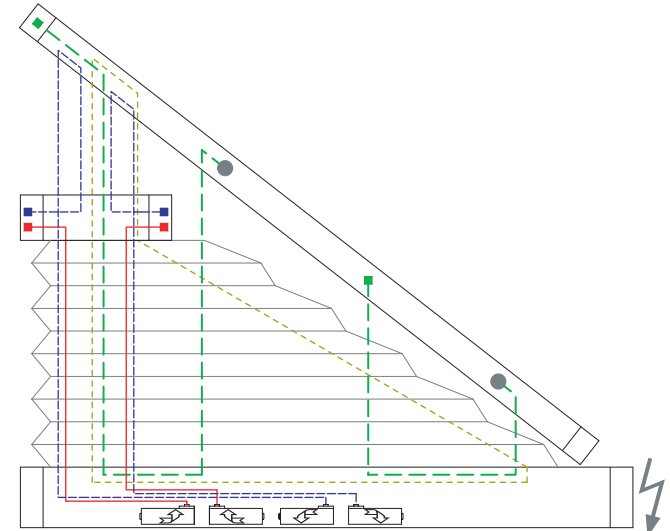

4 Drahtbohrungen/Wire boreholes/Passages de fil

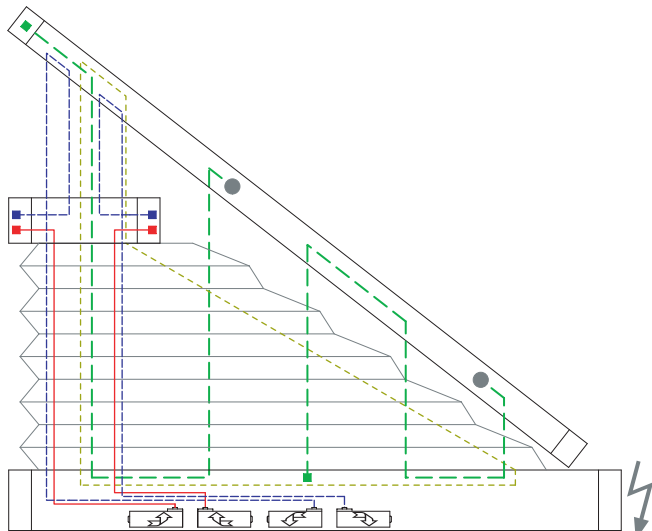

5 Drahtbohrungen/Wire boreholes/Passages de fil

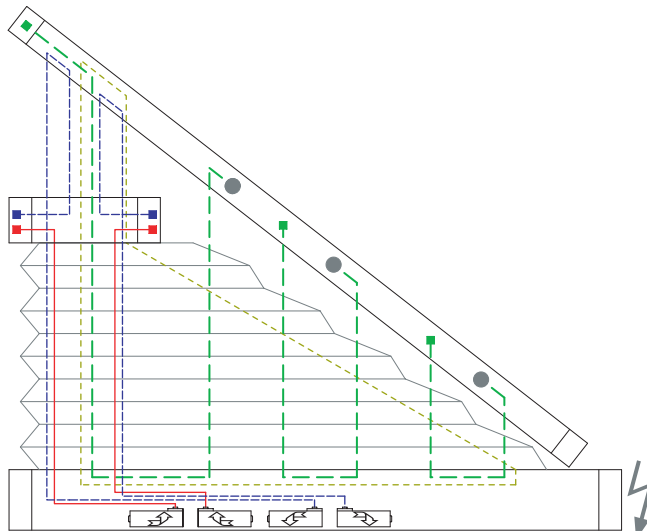

6 Drahtbohrungen/Wire boreholes/Passages de fil



- 1. Wickelschnur/Winding cord/Cordon d'enroulement Ø1,2 mm
- - - 2. Wickelschnur/Winding cord/Cordon d'enroulement Ø1,2 mm
- - - Gummiband/Rubber band/Ruban en caoutchouc Ø1,25 mm
- SOMFY CTS 25 Schnurwickler/Cord winder/Dévidoir de cordon



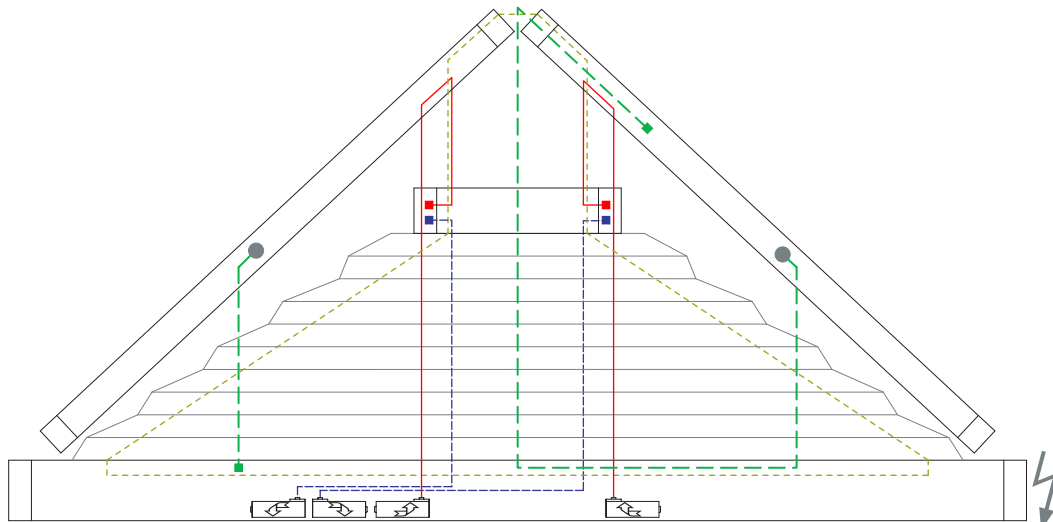

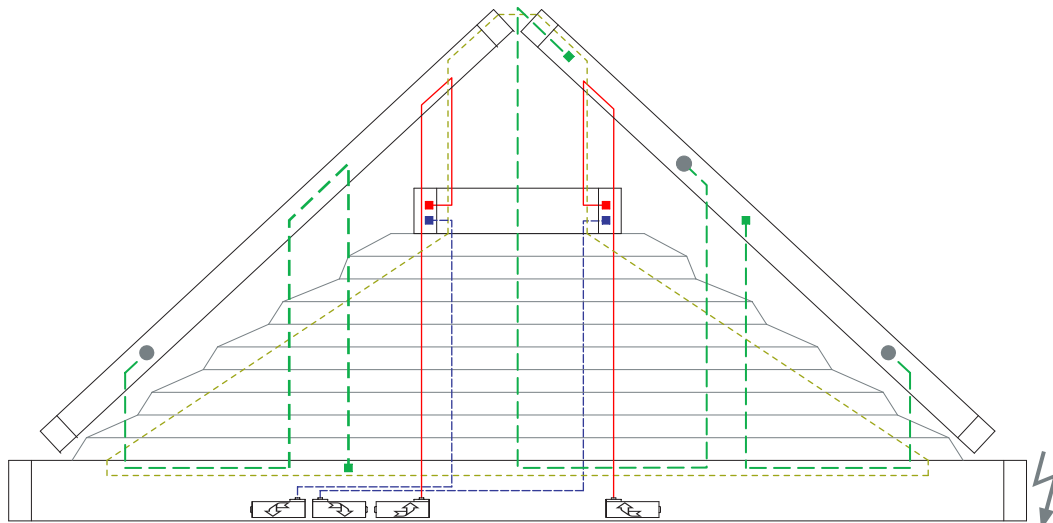
- - - Spanndraht/Tension wire/Fil de tension Ø0,8 mm
- Drahtspanner/Wire stretcher/Tendeur de fil



3 Drahtbohrungen/Wire boreholes/Passages de fil

5 Drahtbohrungen/Wire boreholes/Passages de fil

7 Drahtbohrungen/Wire boreholes/Passages de fil



P 3962-1

-  1. Wickelschnur/Winding cord/Cordon d'enroulement Ø1,2 mm
-  2. Wickelschnur/Winding cord/Cordon d'enroulement Ø1,2 mm
-  Spanndraht/Tension wire/Fil de tension Ø0,8 mm
-  SOMFY CTS 25 Schnurwickler/Cord winder/Dévidoir de cordon

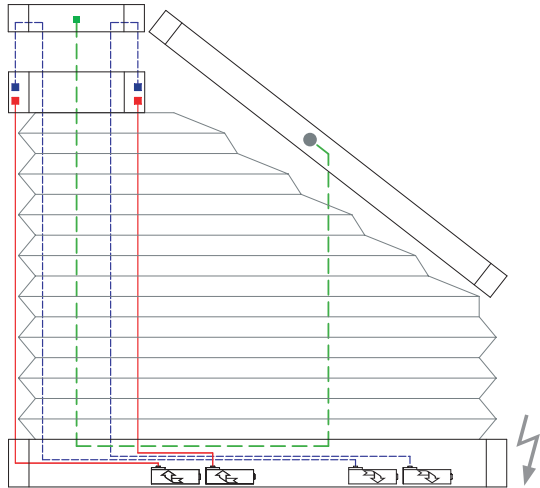
-  Drahtspanner/Wire stretcher/Tendeur de fil



2 Drahtbohrungen/Wire boreholes/Passages de fil

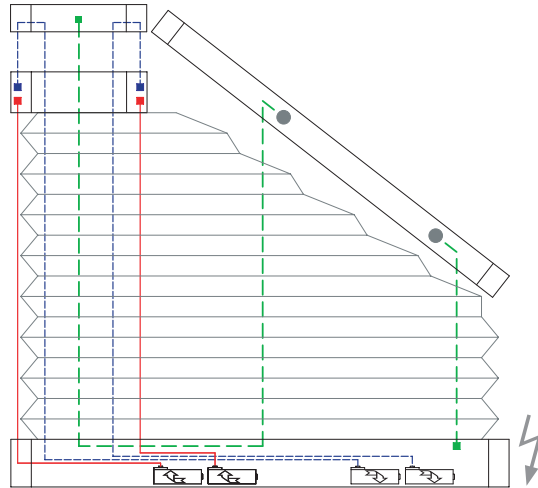

3 Drahtbohrungen/Wire boreholes/Passages de fil

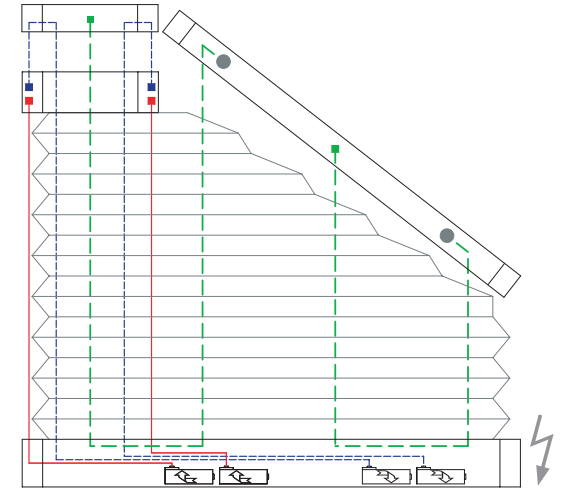

4 Drahtbohrungen/Wire boreholes/Passages de fil

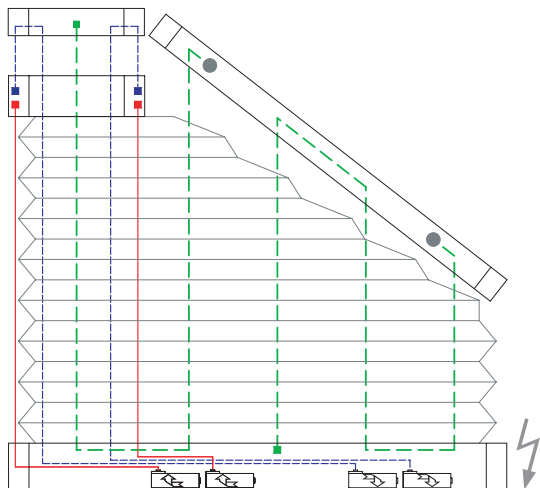

5 Drahtbohrungen/Wire boreholes/Passages de fil

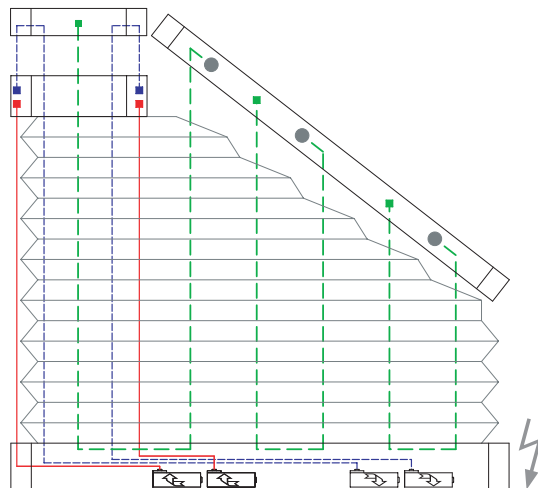

6 Drahtbohrungen/Wire boreholes/Passages de fil

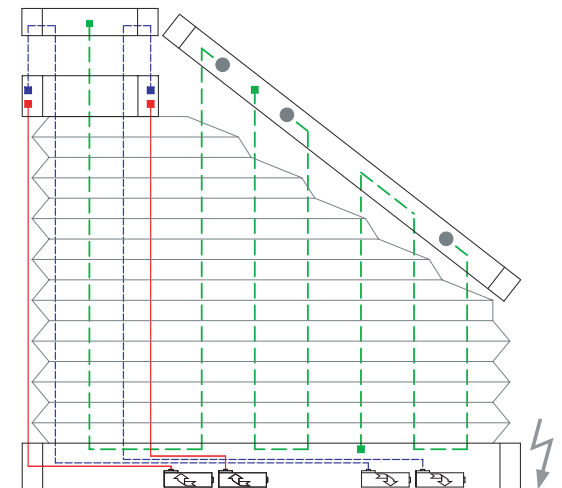

7 Drahtbohrungen/Wire boreholes/Passages de fil



P 3962-2

- 1. Wickelschnur/Winding cord/Cordon d'enroulement Ø1,2 mm
- - - 2. Wickelschnur/Winding cord/Cordon d'enroulement Ø1,2 mm
- - - Spanndraht/Tension wire/Fil de tension Ø0,8 mm
- SOMFY CTS 25 Schnurwickler/Cord winder/Dévidoir de cordon

- Drahtspanner/Wire stretcher/Tendeur de fil
- ⊠ Schnurspanner/Cord stretcher/Tendeur de cordon

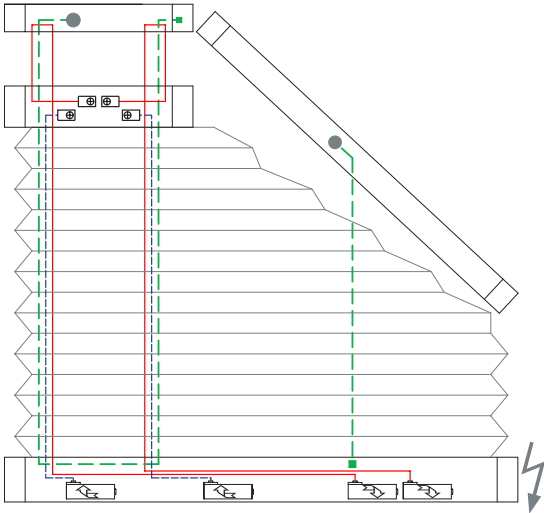

3 Drahtbohrungen/Wire boreholes/Passages de fil

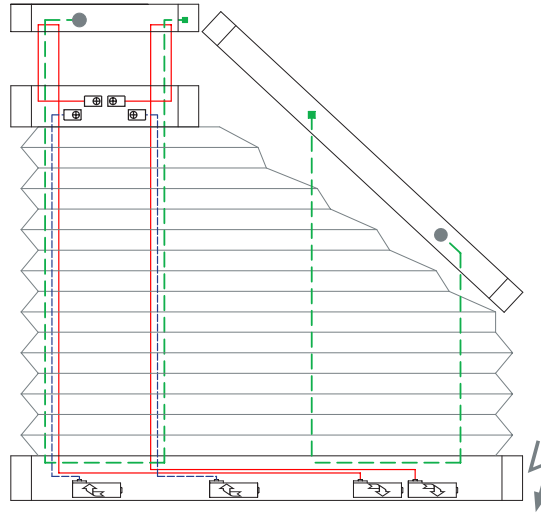

4 Drahtbohrungen/Wire boreholes/Passages de fil

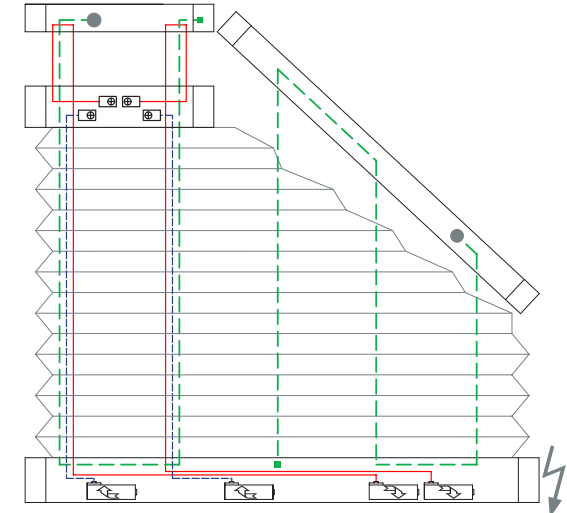

5 Drahtbohrungen/Wire boreholes/Passages de fil

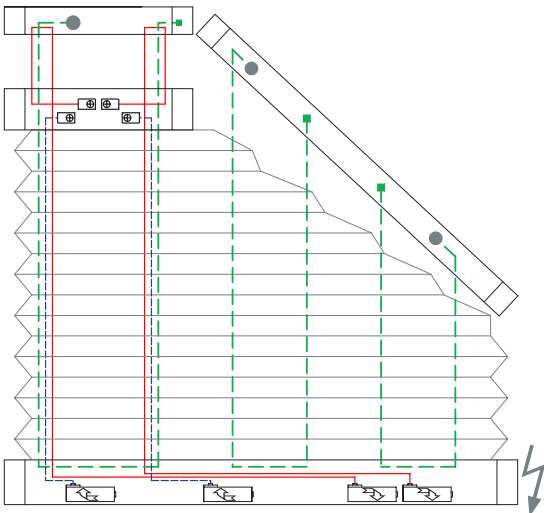

6 Drahtbohrungen/Wire boreholes/Passages de fil

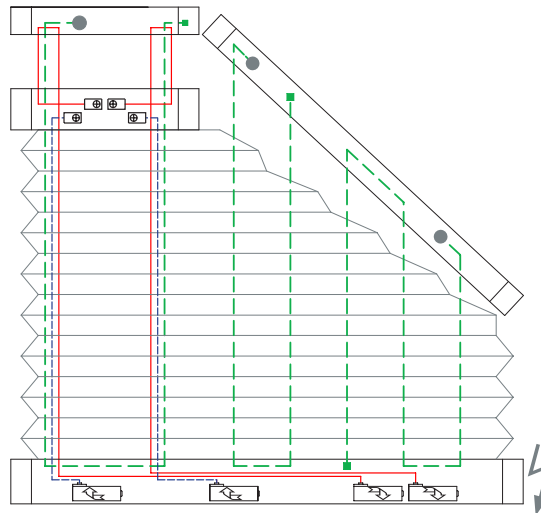

7 Drahtbohrungen/Wire boreholes/Passages de fil



P 3962-3

- 1. Wickelschnur/Winding cord/Cordon d'enroulement Ø1,2 mm
- - - 2. Wickelschnur/Winding cord/Cordon d'enroulement Ø1,2 mm
- - - Spanndraht/Tension wire/Fil de tension Ø0,8 mm
- SOMFY CTS 25 Schnurwickler/Cord winder/Dévidoir de cordon

- Drahtspanner/Wire stretcher/Tendeur de fil
- Schnurspanner/Cord stretcher/Tendeur de cordon



4 Drahtbohrungen/Wire boreholes/Passages de fil

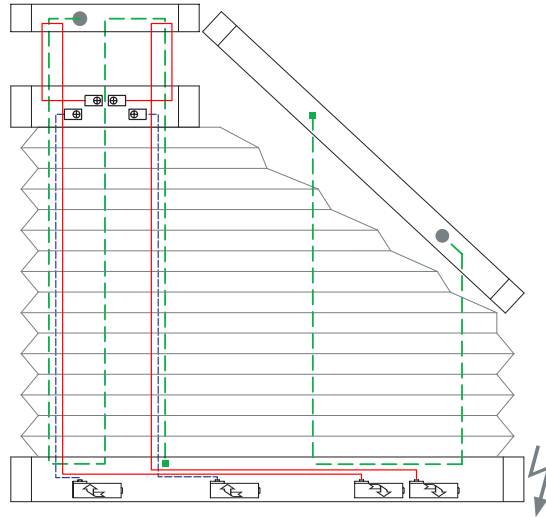

5 Drahtbohrungen/Wire boreholes/Passages de fil



6 Drahtbohrungen/Wire boreholes/Passages de fil

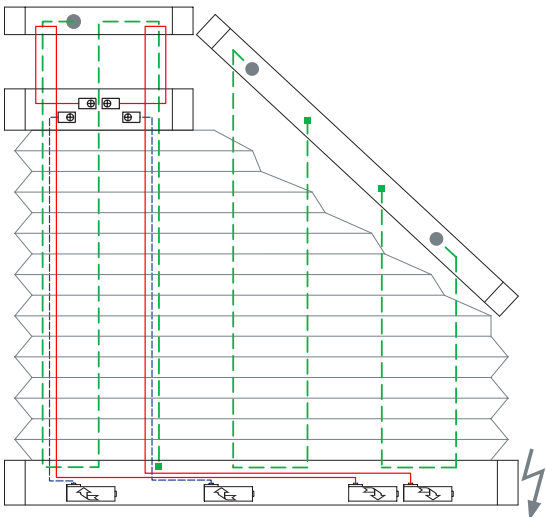

7 Drahtbohrungen/Wire boreholes/Passages de fil



P 3962-4

- 1. Wickelschnur/Winding cord/Cordon d'enroulement Ø1,2 mm
- - - 2. Wickelschnur/Winding cord/Cordon d'enroulement Ø1,2 mm
- - - Spanndraht/Tension wire/Fil de tension Ø0,8 mm
- SOMFY CTS 25 Schnurwickler/Cord winder/Dévidoir de cordon

- Drahtspanner/Wire stretcher/Tendeur de fil
- Schnurspanner/Cord stretcher/Tendeur de cordon

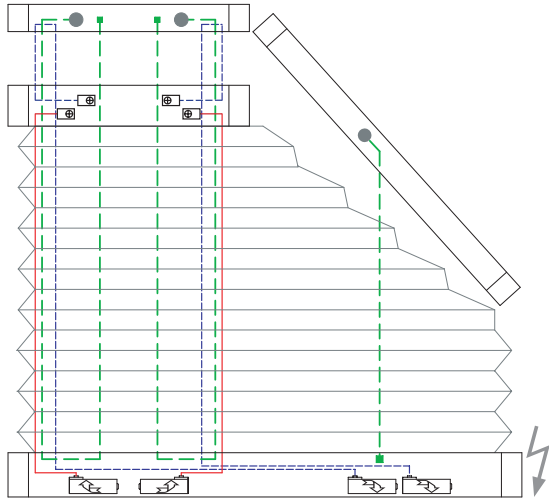

5 Drahtbohrungen/Wire boreholes/Passages de fil

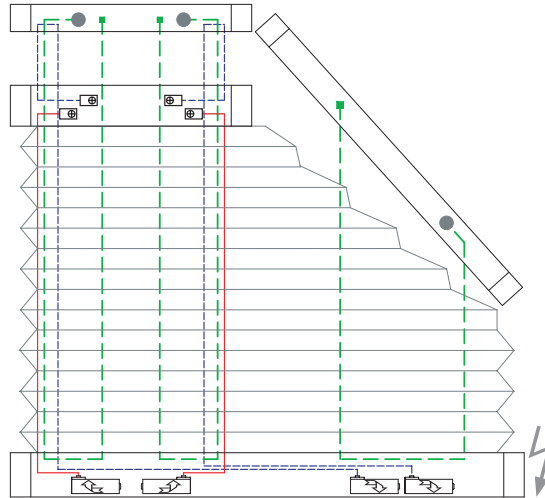

6 Drahtbohrungen/Wire boreholes/Passages de fil

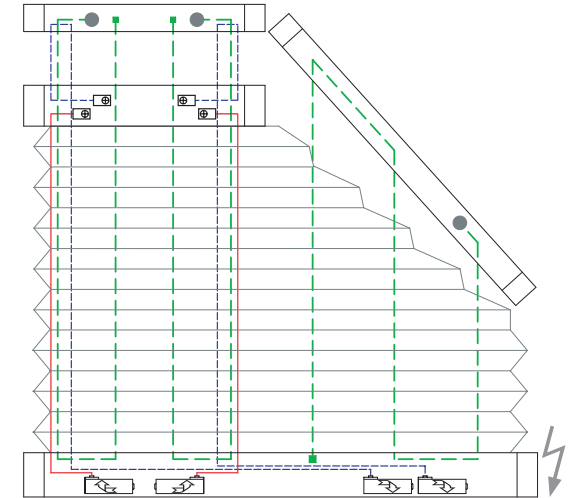

7 Drahtbohrungen/Wire boreholes/Passages de fil



P 3962-5

- 1. Wickelschnur/Winding cord/Cordon d'enroulement Ø1,2 mm
- - - 2. Wickelschnur/Winding cord/Cordon d'enroulement Ø1,2 mm
- - - Spanndraht/Tension wire/Fil de tension Ø0,8 mm
- SOMFY CTS 25 Schnurwickler/Cord winder/Dévidoir de cordon

- Drahtspanner/Wire stretcher/Tendeur de fil
- Schnurspanner/Cord stretcher/Tendeur de cordon

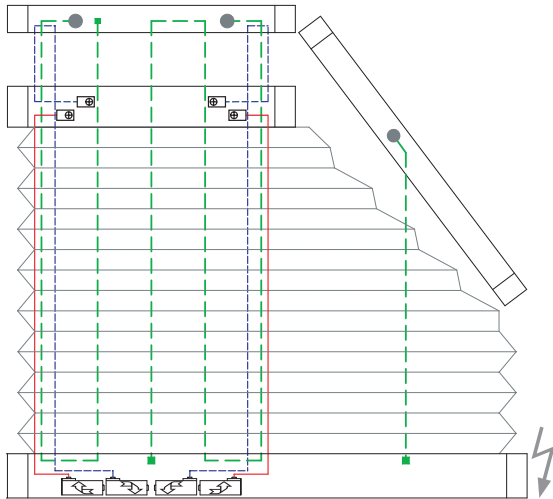

6 Drahtbohrungen/Wire boreholes/Passages de fil

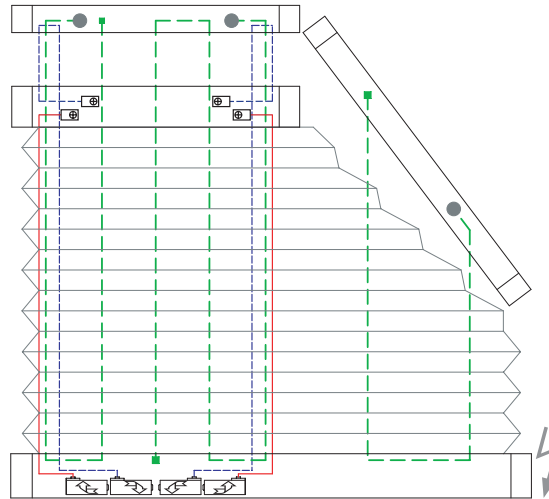



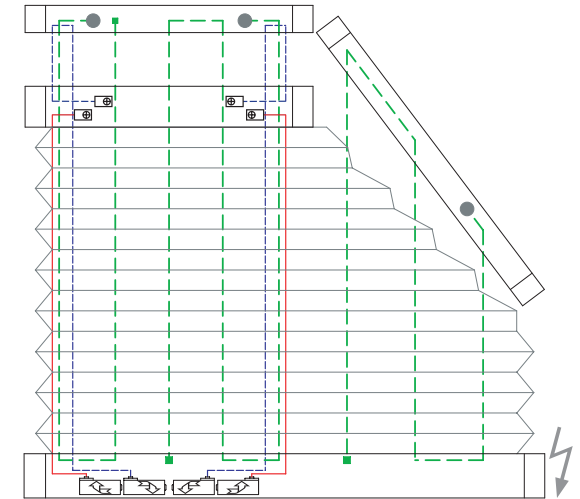

7 Drahtbohrungen/Wire boreholes/Passages de fil





8 Drahtbohrungen/Wire boreholes/Passages de fil



P 3962-6

-  1. Wickelschnur/Winding cord/Cordon d'enroulement Ø1,2 mm
-  2. Wickelschnur/Winding cord/Cordon d'enroulement Ø1,2 mm
-  Spanndraht/Tension wire/Fil de tension Ø0,8 mm
-  SOMFY CTS 25 Schnurwickler/Cord winder/Dévidoir de cordon

-  Drahtspanner/Wire stretcher/Tendeur de fil
-  Schnurspanner/Cord stretcher/Tendeur de cordon

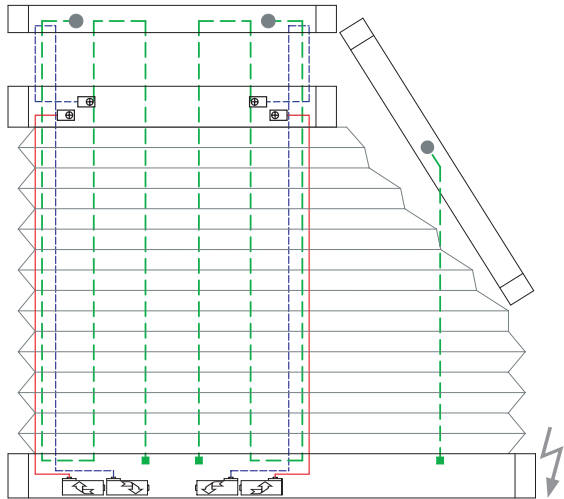



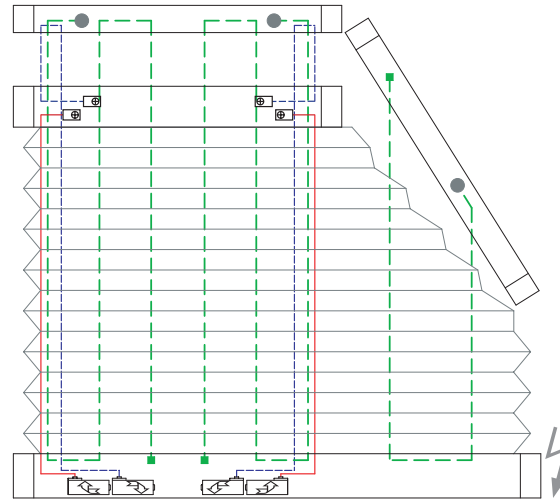

7 Drahtbohrungen/Wire boreholes/Passages de fil





8 Drahtbohrungen/Wire boreholes/Passages de fil



P 3963-2

-  1. Wickelschnur/Winding cord/Cordon d'enroulement Ø1,2 mm
-  2. Wickelschnur/Winding cord/Cordon d'enroulement Ø1,2 mm
-  Spanndraht/Tension wire/Fil de tension Ø0,8 mm
-  SOMFY CTS 25 Schnurwickler/Cord winder/Dévidoir de cordon

-  Drahtspanner/Wire stretcher/Tendeur de fil
-  Schnurspanner/Cord stretcher/Tendeur de cordon

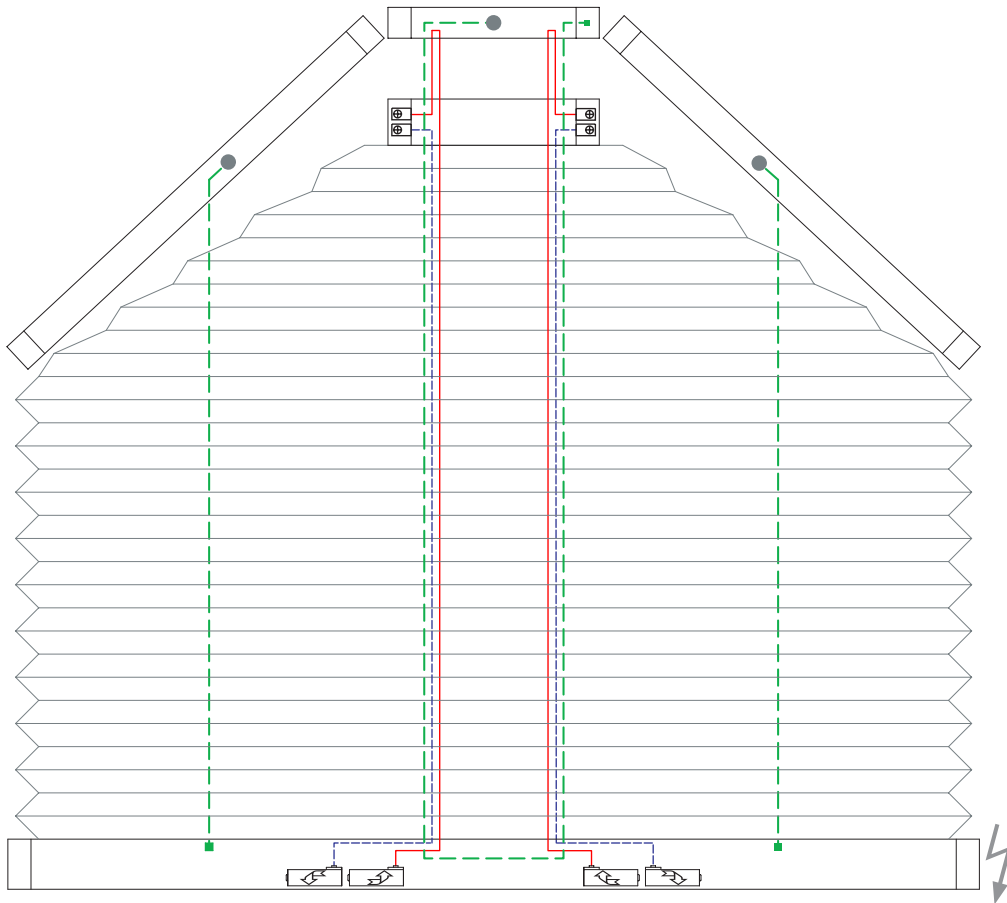





4 Drahtbohrungen/Wire boreholes/Passages de fil





6 Drahtbohrungen/Wire boreholes/Passages de fil



P 3963-2

-  1. Wickelschnur/Winding cord/Cordon d'enroulement Ø1,2 mm
-  2. Wickelschnur/Winding cord/Cordon d'enroulement Ø1,2 mm
-  Spanndraht/Tension wire/Fil de tension Ø0,8 mm
-  SOMFY CTS 25 Schnurwickler/Cord winder/Dévidoir de cordon

-  Drahtspanner/Wire stretcher/Tendeur de fil
-  Schnurspanner/Cord stretcher/Tendeur de cordon

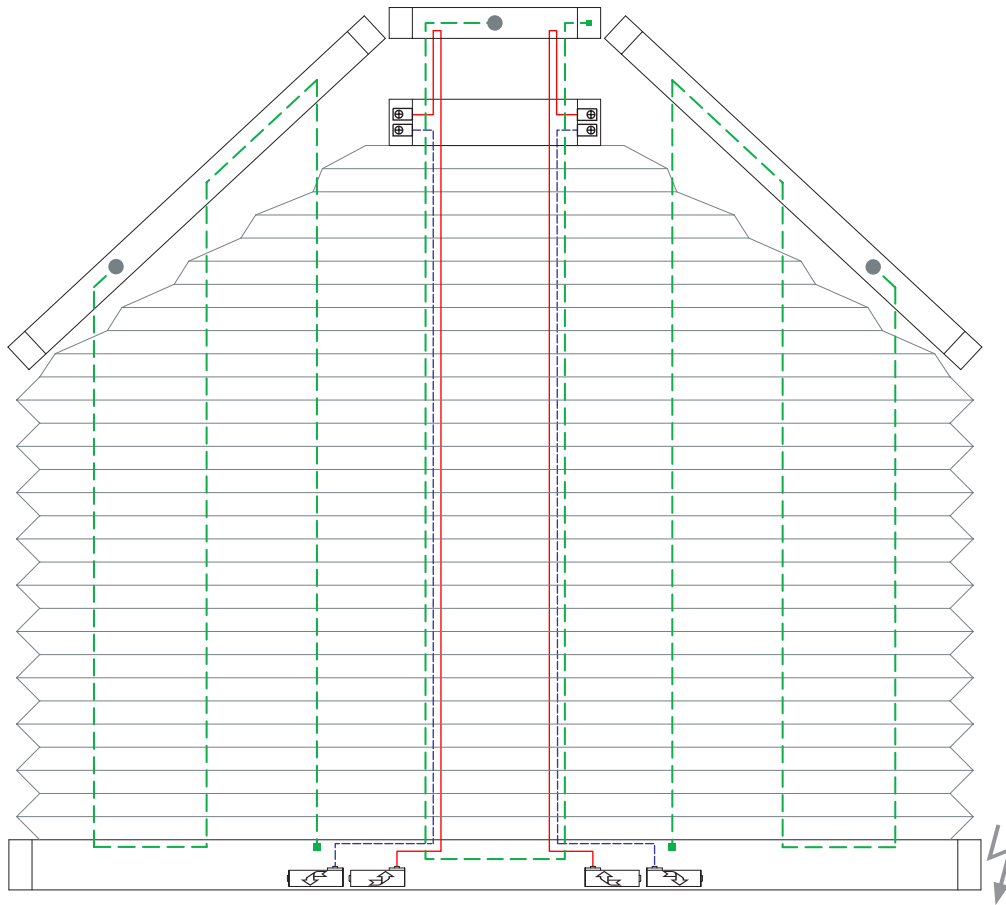

8 Drahtbohrungen/Wire boreholes/Passages de fil

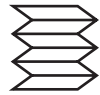

P 3963-3

- 1. Wickelschnur/Winding cord/Cordon d'enroulement Ø1,2 mm
- - - 2. Wickelschnur/Winding cord/Cordon d'enroulement Ø1,2 mm
- - - Spanndraht/Tension wire/Fil de tension Ø0,8 mm
- SOMFY CTS 25 Schnurwickler/Cord winder/Dévidoir de cordon

- Drahtspanner/Wire stretcher/Tendeur de fil
- Schnurspanner/Cord stretcher/Tendeur de cordon

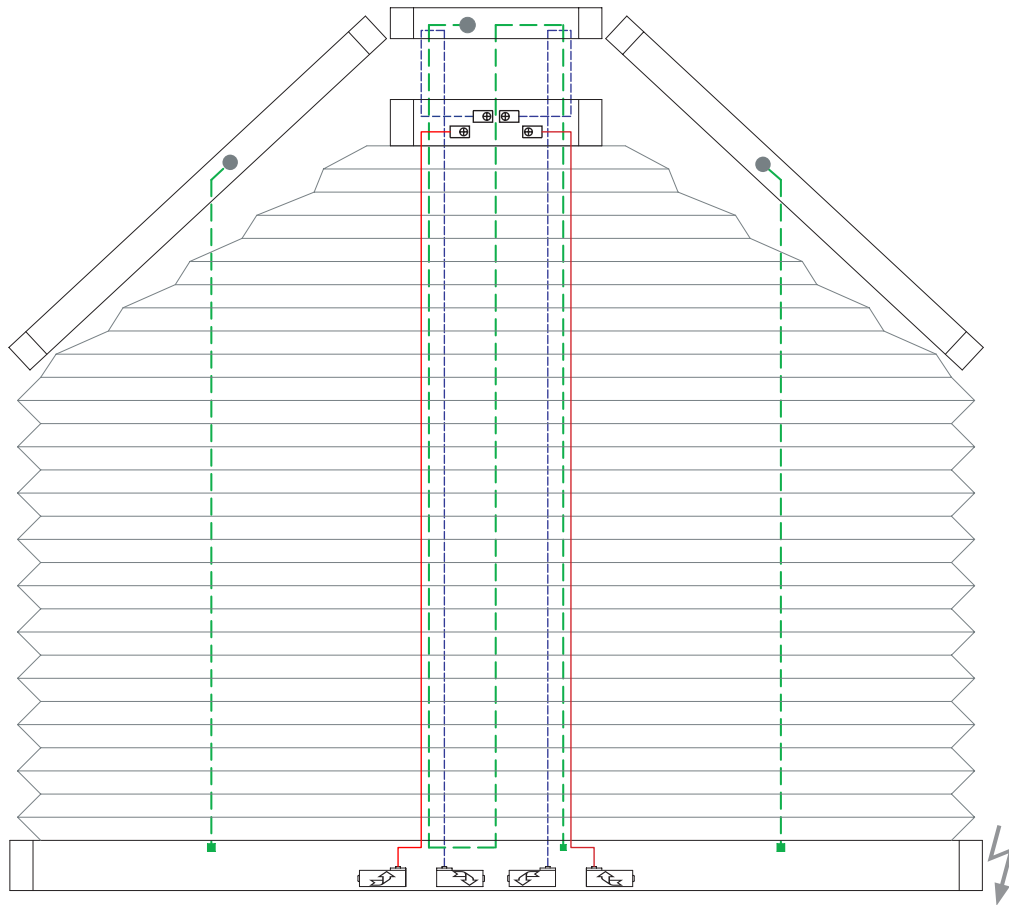



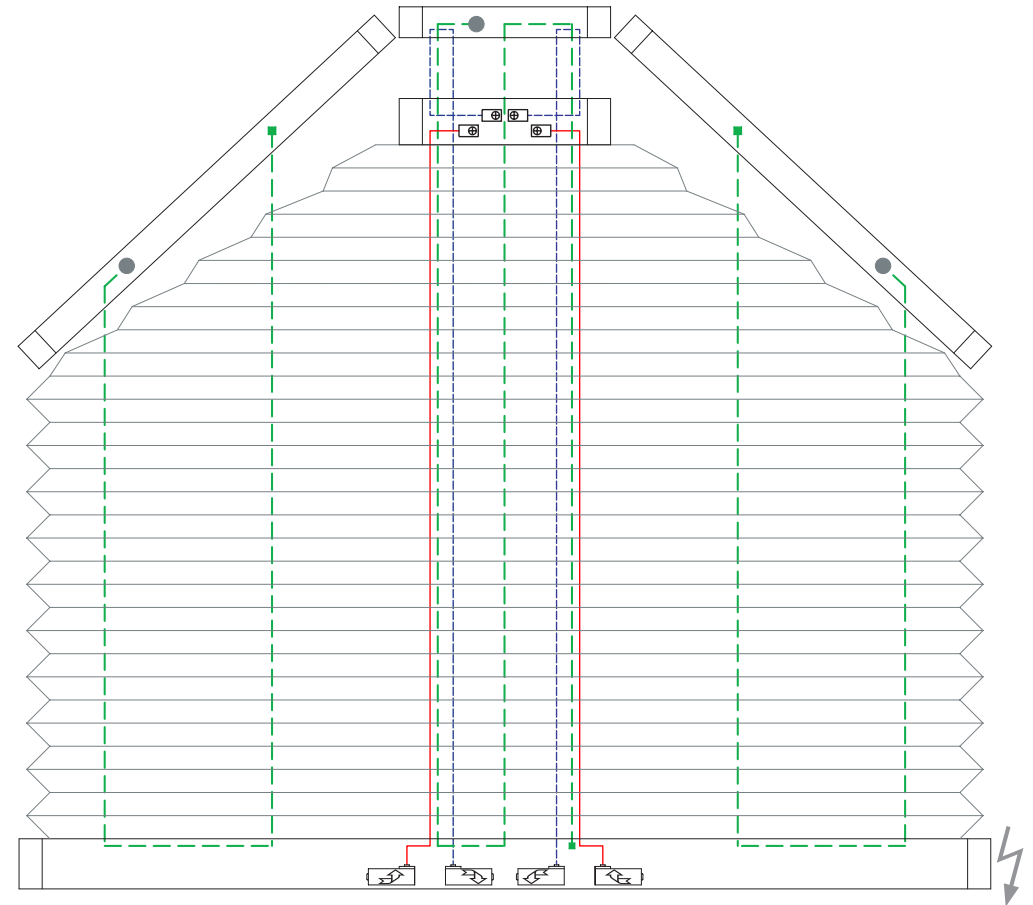

5 Drahtbohrungen/Wire boreholes/Passages de fil





7 Drahtbohrungen/Wire boreholes/Passages de fil



P 3963-3

-  1. Wickelschnur/Winding cord/Cordon d'enroulement Ø1,2 mm
-  2. Wickelschnur/Winding cord/Cordon d'enroulement Ø1,2 mm
-  Spanndraht/Tension wire/Fil de tension Ø0,8 mm
-  SOMFY CTS 25 Schnurwickler/Cord winder/Dévidoir de cordon

-  Drahtspanner/Wire stretcher/Tendeur de fil
-  Schnurspanner/Cord stretcher/Tendeur de cordon

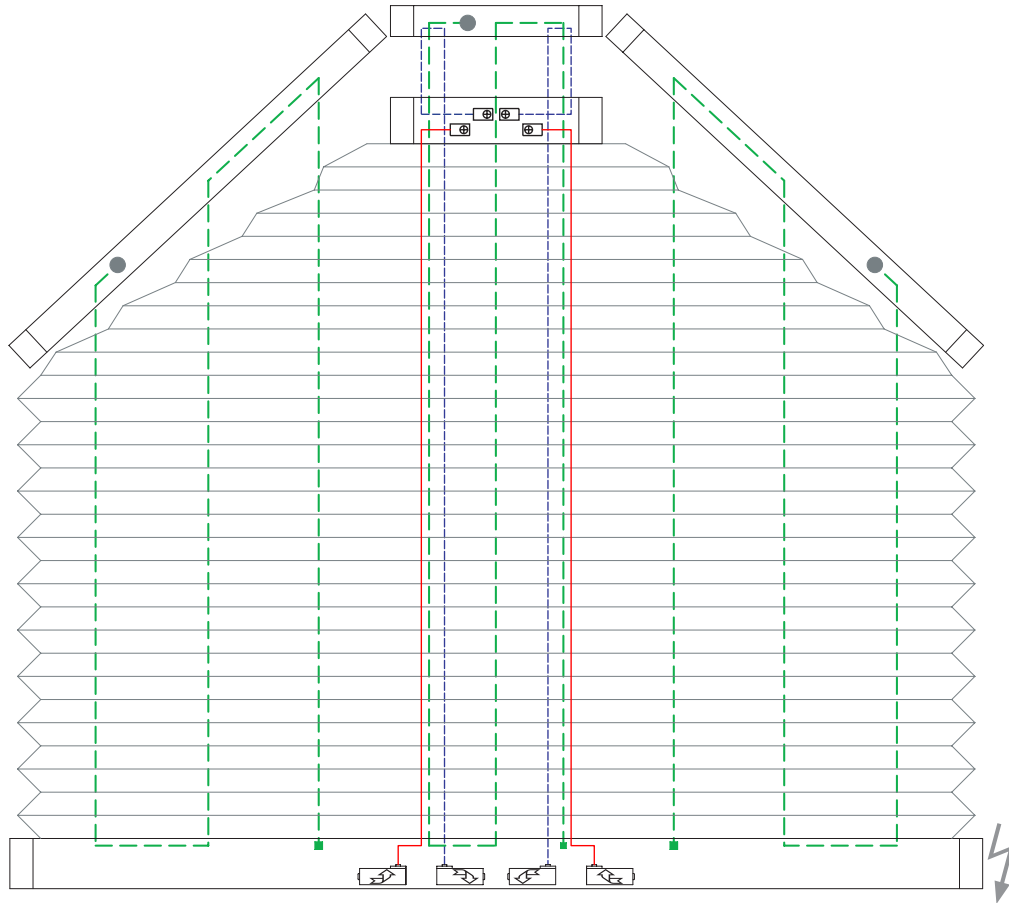

9 Drahtbohrungen/Wire boreholes/Passages de fil



- 1. Wickelschnur/Winding cord/Cordon d'enroulement Ø1,2 mm
- - - 2. Wickelschnur/Winding cord/Cordon d'enroulement Ø1,2 mm
- - - Spanndraht/Tension wire/Fil de tension Ø0,8 mm
- SOMFY CTS 25 Schnurwickler/Cord winder/Dévidoir de cordon

- Drahtspanner/Wire stretcher/Tendeur de fil
- ⊞ Schnurspanner/Cord stretcher/Tendeur de cordon

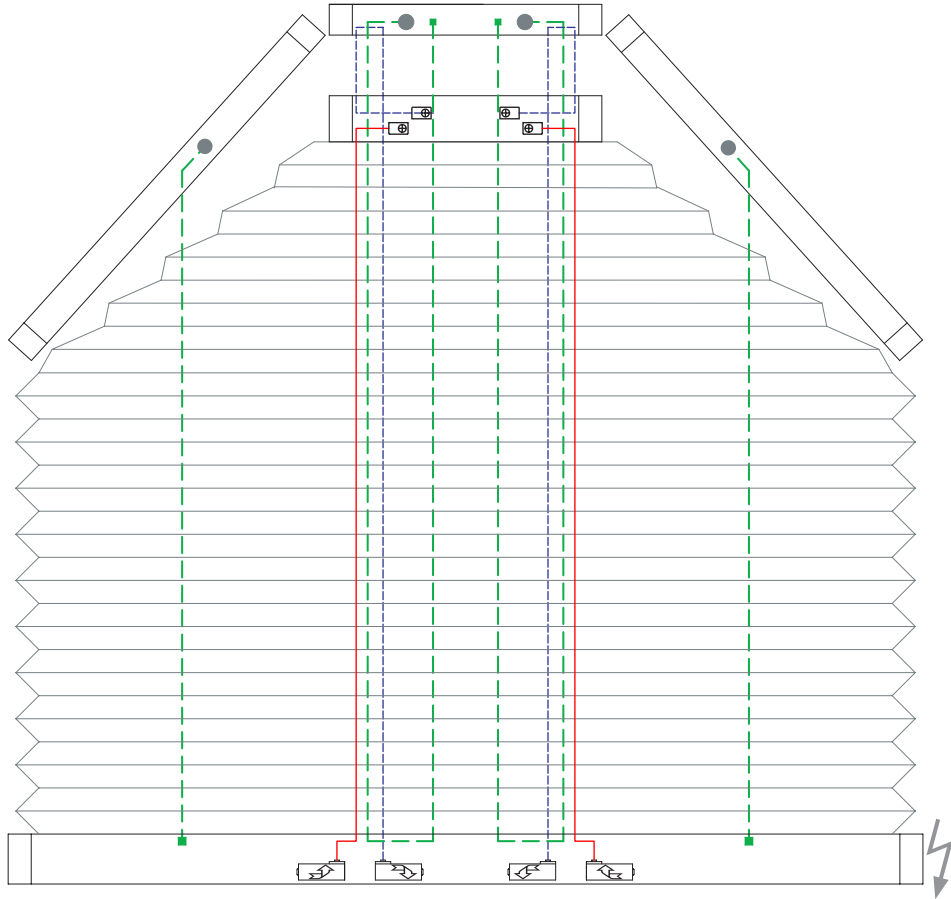



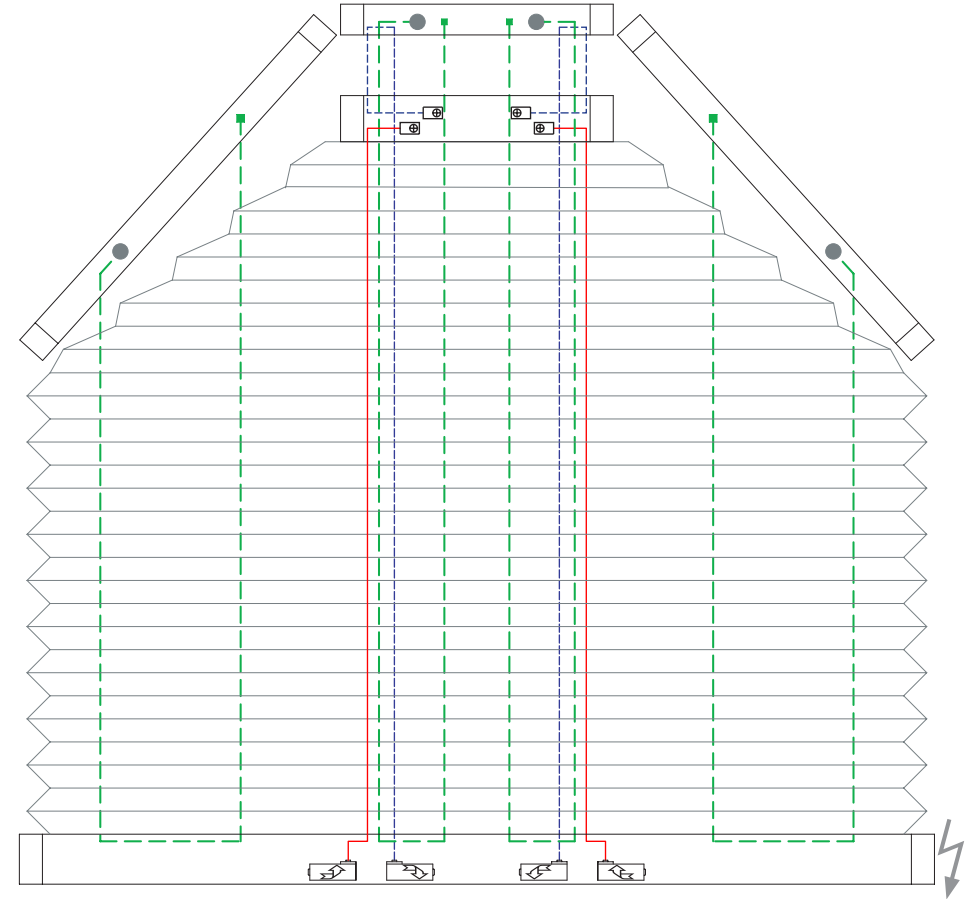

6 Drahtbohrungen/Wire boreholes/Passages de fil





8 Drahtbohrungen/Wire boreholes/Passages de fil



P 3963-5

-  1. Wickelschnur/Winding cord/Cordon d'enroulement Ø1,2 mm
-  2. Wickelschnur/Winding cord/Cordon d'enroulement Ø1,2 mm
-  Spanndraht/Tension wire/Fil de tension Ø0,8 mm
-  SOMFY CTS 25 Schnurwickler/Cord winder/Dévidoir de cordon



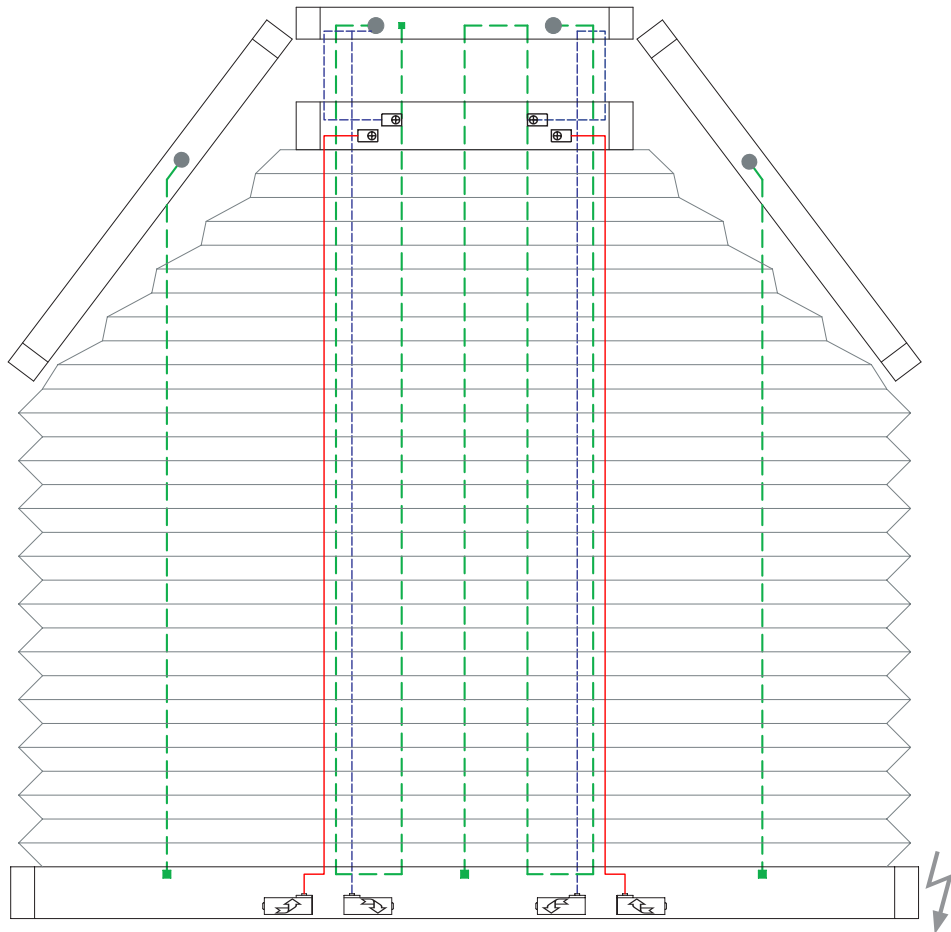

-  Drahtspanner/Wire stretcher/Tendeur de fil
-  Schnurspanner/Cord stretcher/Tendeur de cordon





7 Drahtbohrungen/Wire boreholes/Passages de fil



P 3963-6

-  1. Wickelschnur/Winding cord/Cordon d'enroulement Ø1,2 mm
-  2. Wickelschnur/Winding cord/Cordon d'enroulement Ø1,2 mm
-  Spanndraht/Tension wire/Fil de tension Ø0,8 mm
-  SOMFY CTS 25 Schnurwickler/Cord winder/Dévidoir de cordon

-  Drahtspanner/Wire stretcher/Tendeur de fil
-  Schnurspanner/Cord stretcher/Tendeur de cordon

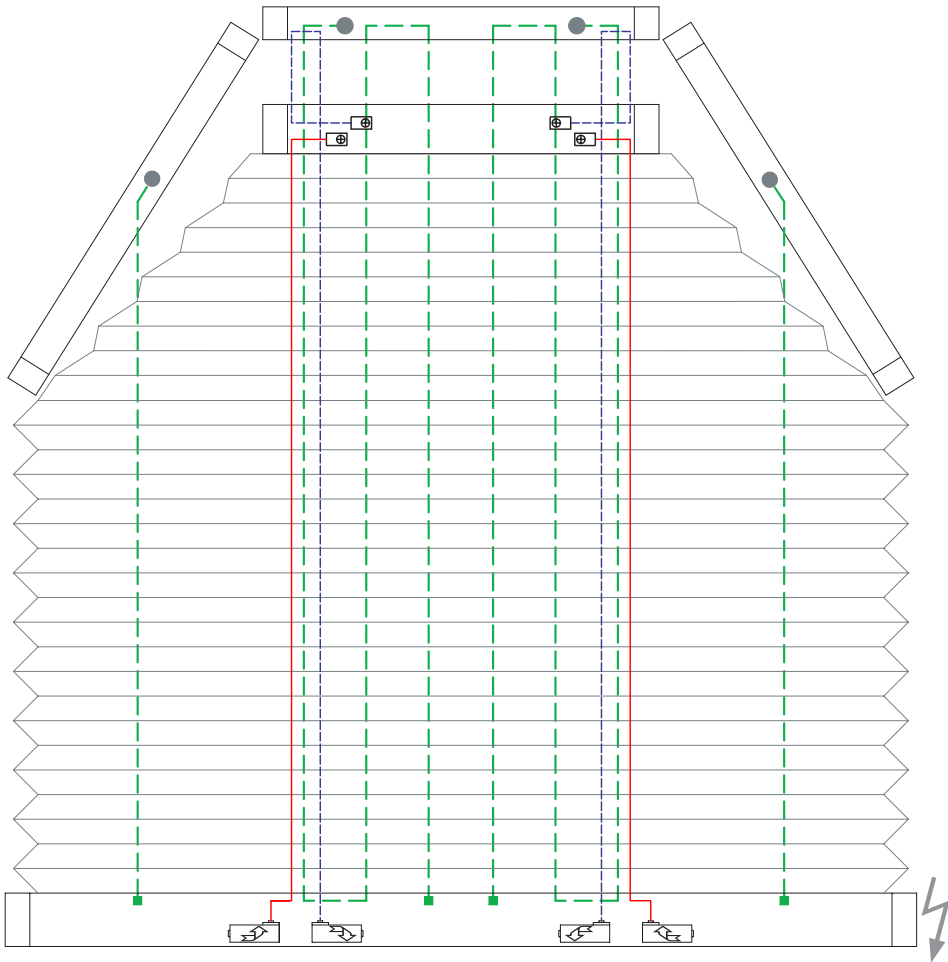

8 Drahtbohrungen/Wire boreholes/Passages de fil